

! INFO !

Do not charge the battery of the towing vehicle and/or towed vehicle directly via the socket.

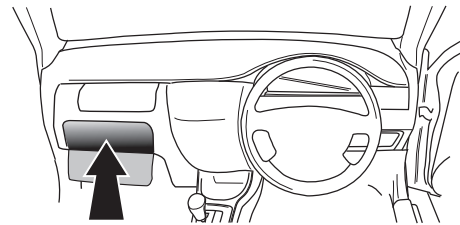

User guide



SPARE PARTS

www.ecs-electronicsuk.co.uk



Partnr.: AU-046-B1U

User Guide

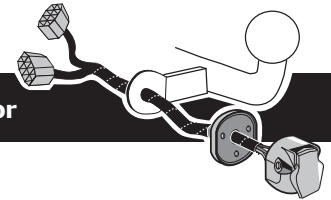

Only for models without towbar prepared connector

- VW Golf VII 5G Limo 10/2012 - 05/2014**
- VW Golf VII 5G Variant 08/2013 - 05/2014**
- Seat Leon Limo 2013 - 05/2014**
- Seat Leon ST 2013 - 05/2014**
- Skoda Octavia Limo 2013 - 05/2014**
- Skoda Octavia Combi 2014 - 05/2014**
- Audi A3 3D 2013 - 05/2014**
- Audi A3 Sportback 2013 - 05/2014**
- Audi A3 Limo 2014 - 05/2014**

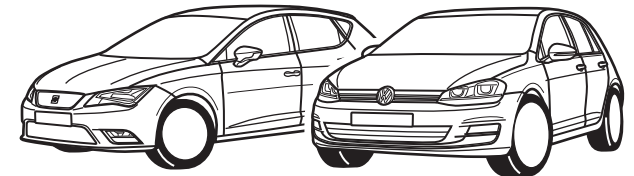
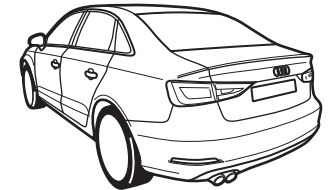

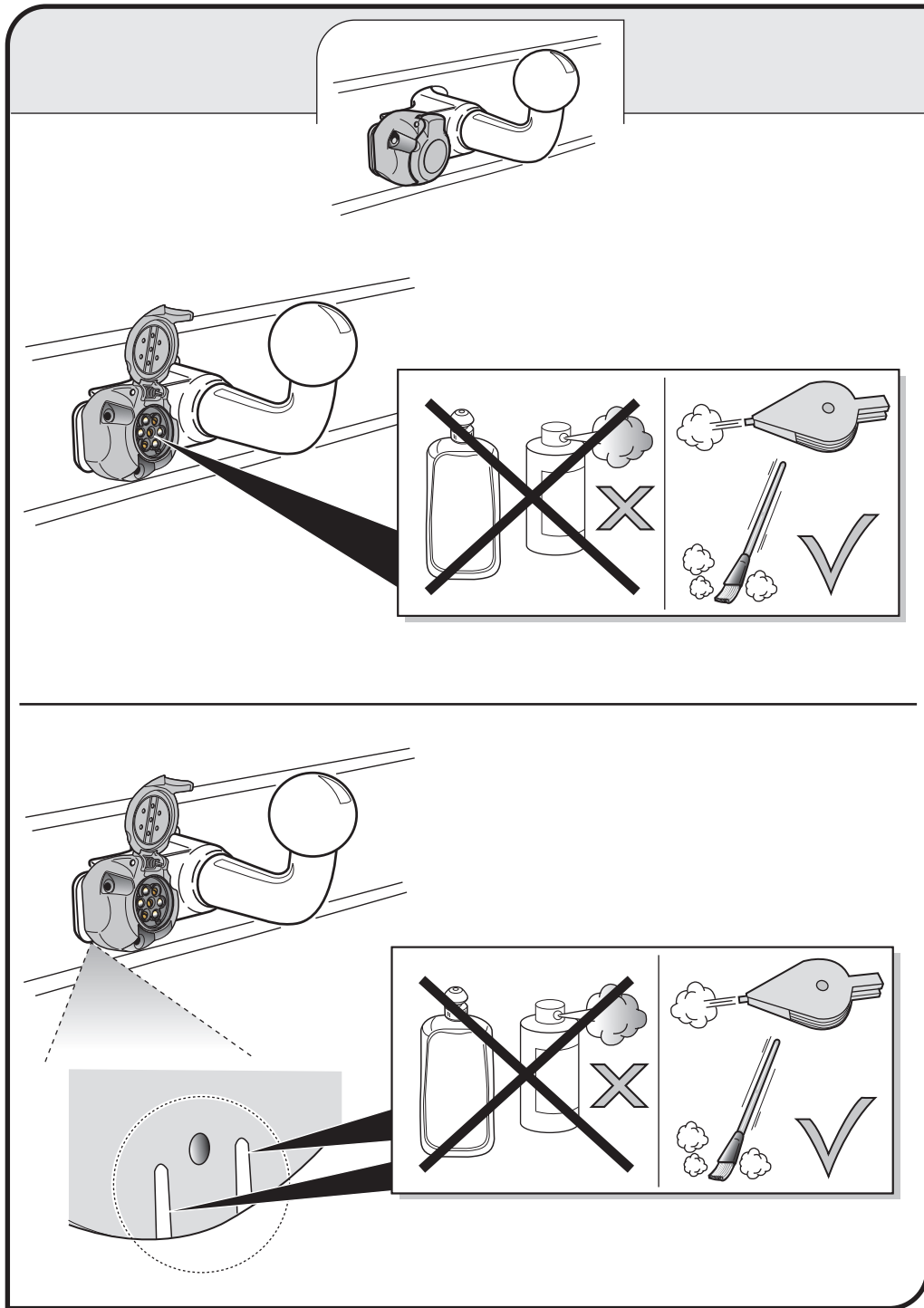

CHANGING THE FUSE

AUDI A3 -2014

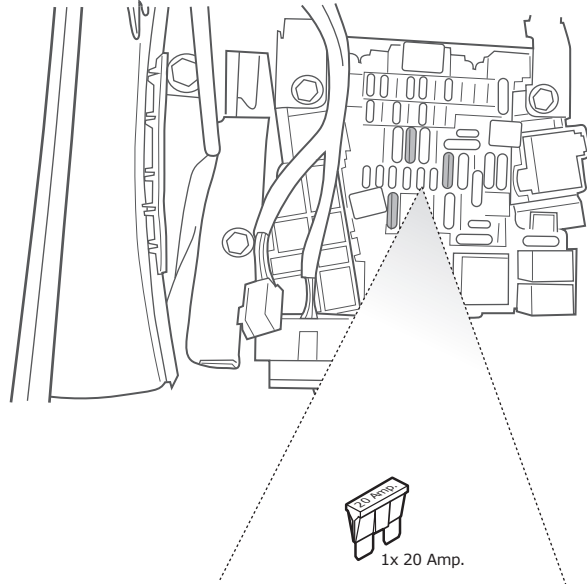
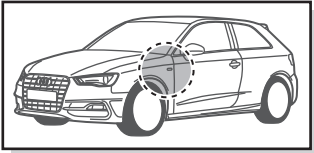

20 Amp.

Pos. 38

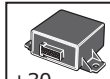

+30



1x 20 Amp.

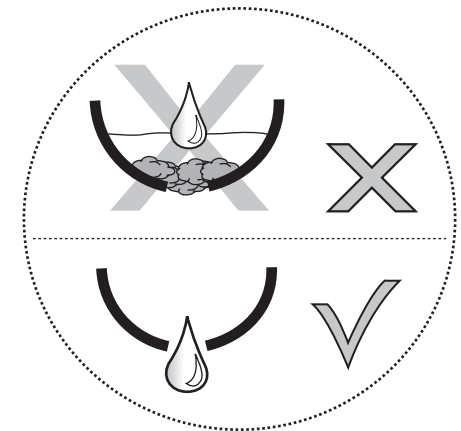
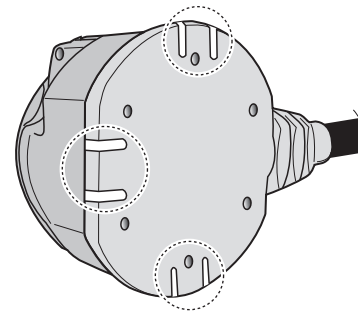
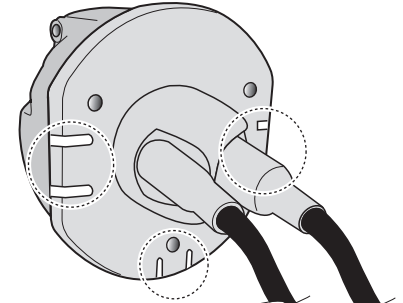
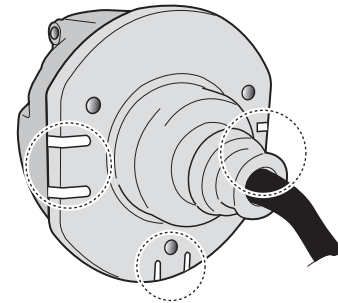
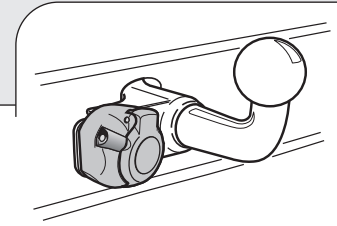

SOCKET CONNECTION

DIN/ISO 1724							
	1/L	2	3/31	4/R	5/58-R	6/54	7/58-L
Pmax	21W	21W		21W	42W	3x21W	42W
Colour	Black/White	Blue	Brown	Black/Green	Grey/Red	Black/Red	Grey/Black



In a coupled trailer with working fog lamp, the fog lamp of the vehicle will be switched off, if applicable.

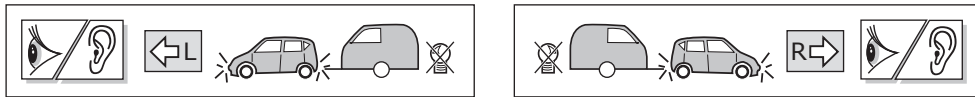

The flashing lights on the trailer are monitored. If one of the indicators of the trailer breaks down, a buzzer will be audible and/or a visual signal will be visible on the dashboard. Check the flashing lights on the trailer.

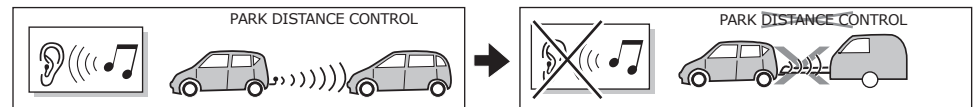

The wiring kit has a possibility to switch off any Park Distance Control in the case of a coupled trailer.

CHANGING THE FUSE

VW Golf VII / Skoda Octavia

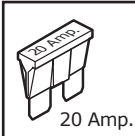
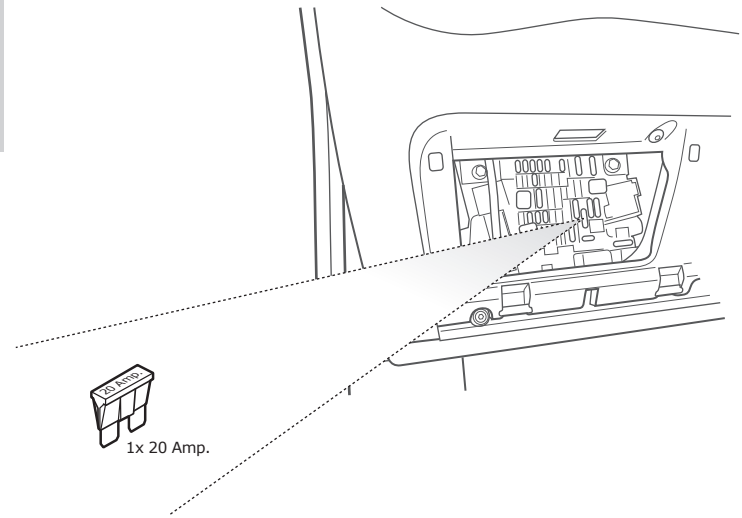
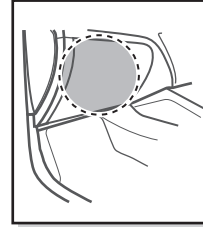

20 Amp.

Pos. 38

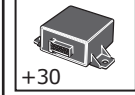

+30

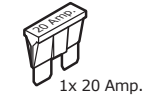

1x 20 Amp.

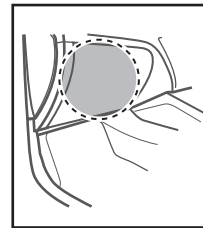

Seat Leon

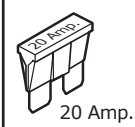
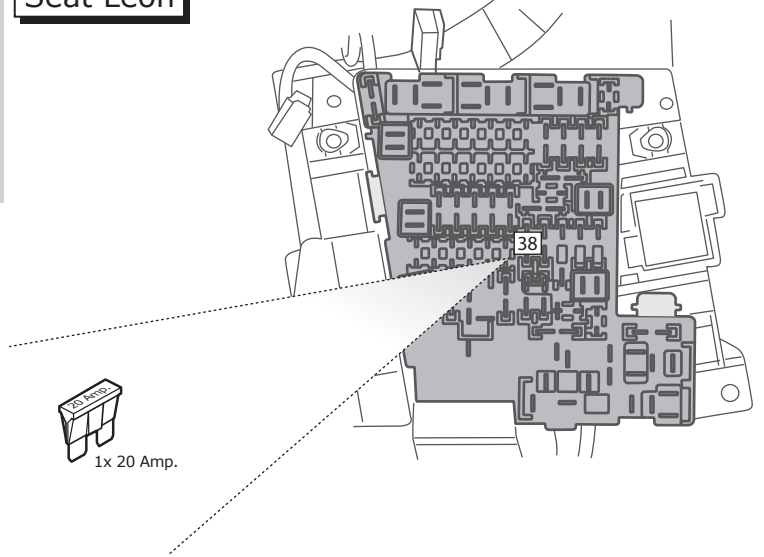

20 Amp.

Pos. 38

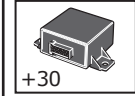

+30

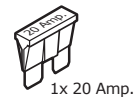

1x 20 Amp.