

! INFO !

Do not charge the battery of the towing vehicle and/or towed vehicle directly via the socket.

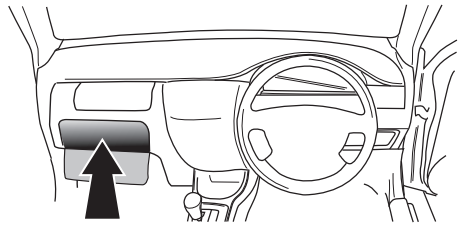

User guide



SPARE PARTS

www.ecs-electronicsuk.co.uk



Partnr.: AU-060-B1U

User Guide

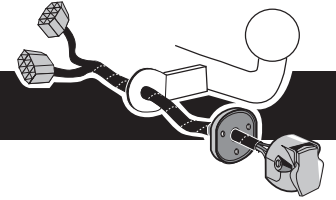

**Audi A6 Sedan 01/2015- (4G)
Audi A7 Sportback 01/2015- (4G)
Audi A6 Avant 01/2015- (4G5)**

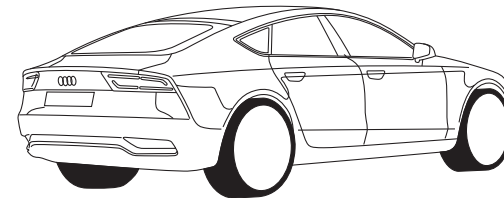
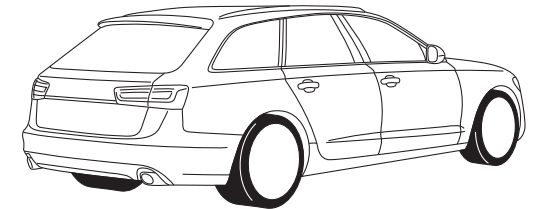
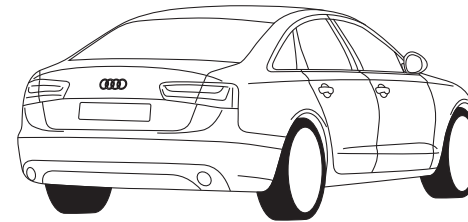

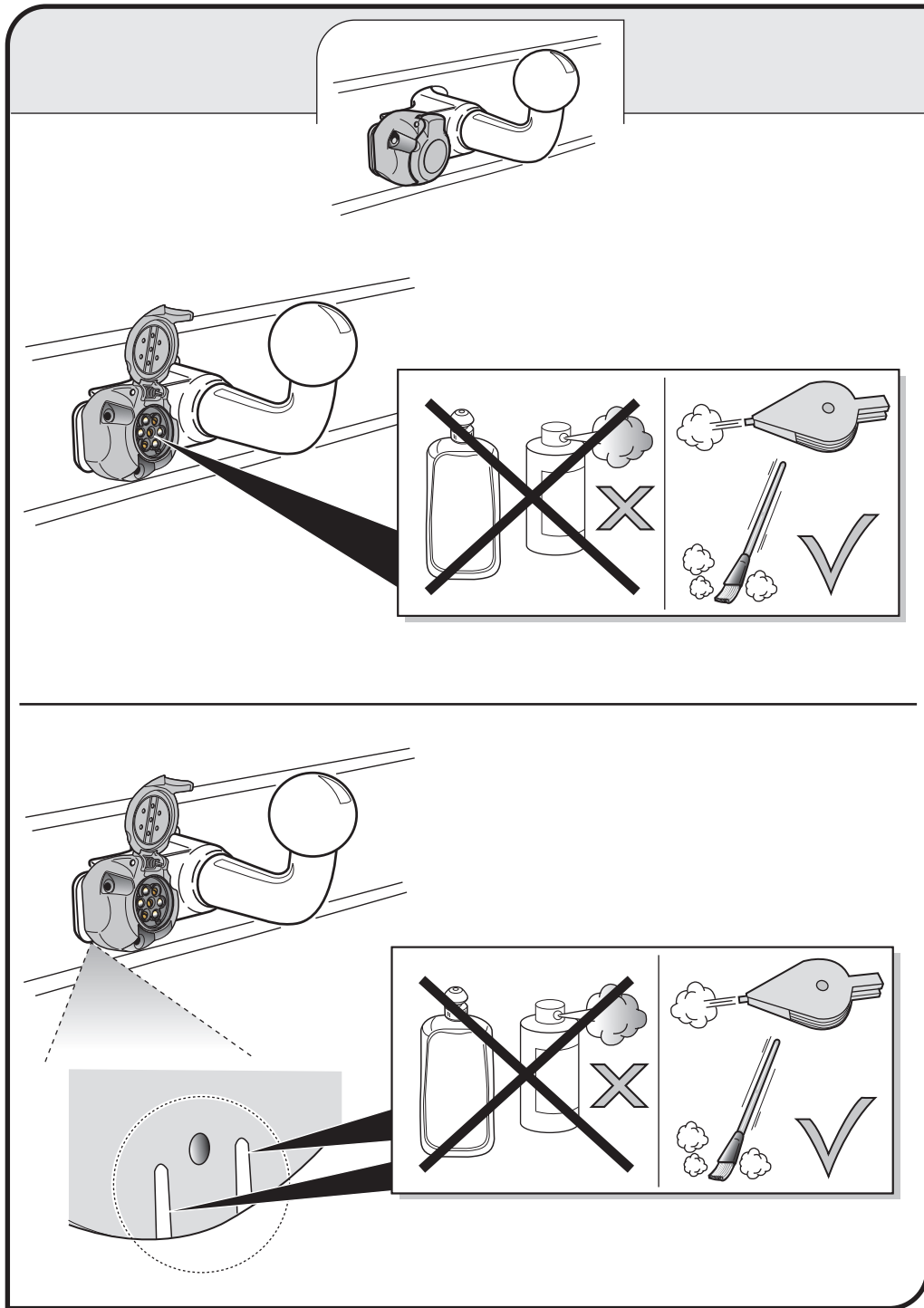

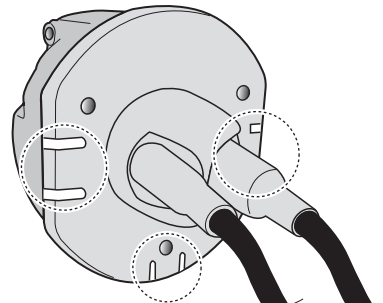

SOCKET CONNECTION

DIN/ISO 1724							
	1/L	2	3/31	4/R	5/58-R	6/54	7/58-L
Pmax	21W	21W		21W	42W	3x21W	42W
Colour	Black/ White	Blue	Brown	Black/ Green	Grey/ Red	Black/ Red	Grey/ Black



In a coupled trailer with working fog lamp, the fog lamp of the vehicle will be switched off, if applicable.



The flashing lights on the trailer are monitored. If one of the indicators of the trailer breaks down, a buzzer will be audible and/or a visual signal will be visible on the dashboard. Check the flashing lights on the trailer.

CHANGING THE FUSE

