

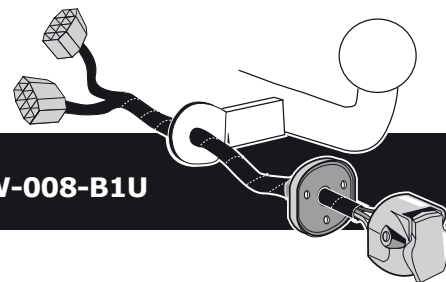

- **BMW 1 Series E81, E82, E87, E88**
- **BMW 1 Series F20, F21 (without PDC cut off function)**
- **BMW 3 Series E90, E91, E92, E93**
- **BMW 3 Series F30, F31, F34 (without PDC cut off function)**
- **BMW 5 Series E60, E61, F07, F10, F11** (for RHD see next page)
- **BMW 7 Series E65, E66, F01, F02**
- **BMW X1 Series E84**
- **BMW X3 Series F25 (without PDC cut off function)**
- **BMW X5 Series E70**
- **BMW X6 Series E71**

This kit doesn't cut off Park Assist , if applicable



Partnr.: BW-008-B1U

- Fitting instructions electric wiring kit tow bar with 12-N socket up to DIN/ISO Norm 1724.
- We would expressly point out that assembly not carried out properly by a competent installer will result in cancellation of any right to damage compensation, in particular those arising by virtue of the product liability act.
- Contents of these kits and their fitting manuals are subject to alteration without notice, please ensure that these instructions are read and fully understood before commencing installation.
- Do not overload circuits; the maximum loads per connection are detailed in this manual.
- Attention! Before Installation, please read this manual carefully and inform your customer to consult the vehicle owners manual to check for any vehicle modifications required before towing.
- In the event of functional problems, troubleshooting must be limited to about 0.5 hours, contact the technical support:
ukts@ecs-electronics.com / 07440 202 052.



Right Hand Drive (RHD)

Installation Supplement Instructions

Updated: 06/06/2013

For RHD installation instruction please note the following:

For the BMW 5 (F10 and F11) series connect the CANbus on the off-side (Driver's side) of the dashboard.

Note: There are CAN wires on the passenger side behind the glove box but these do not carry the towbar roadlighting signals.

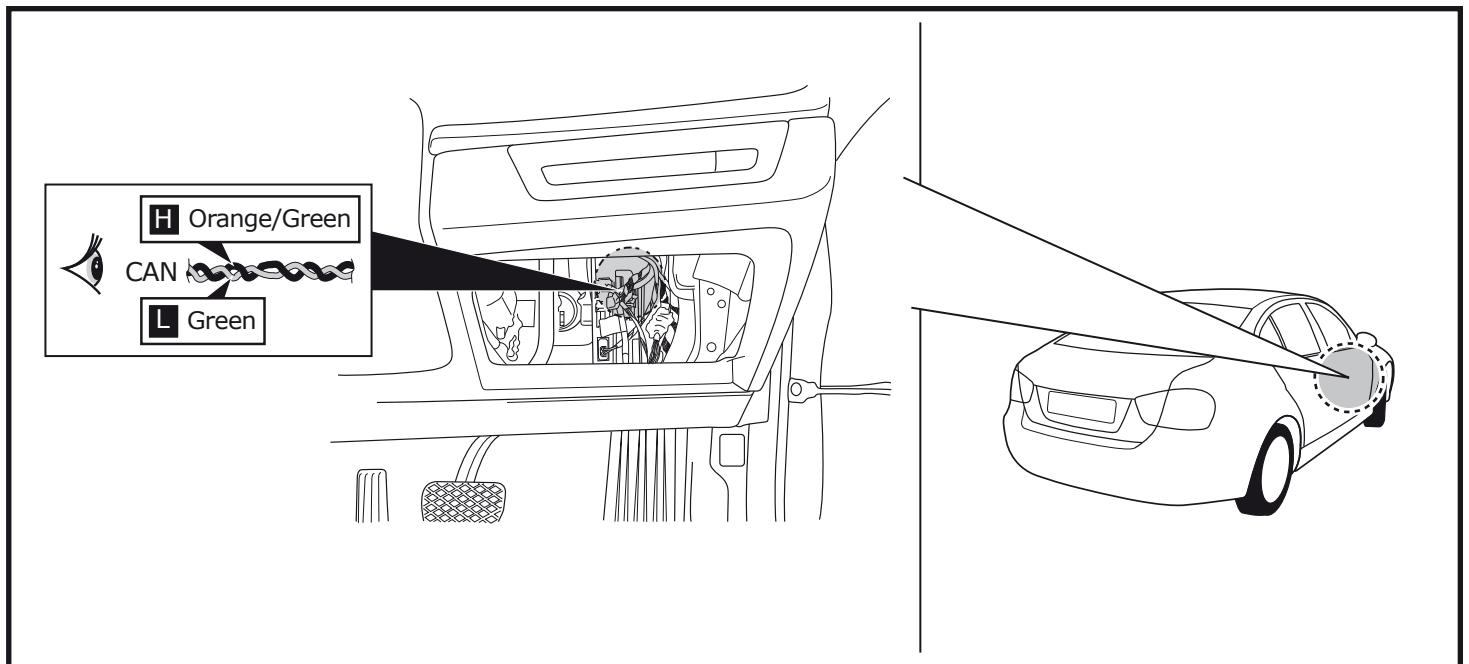

Part list

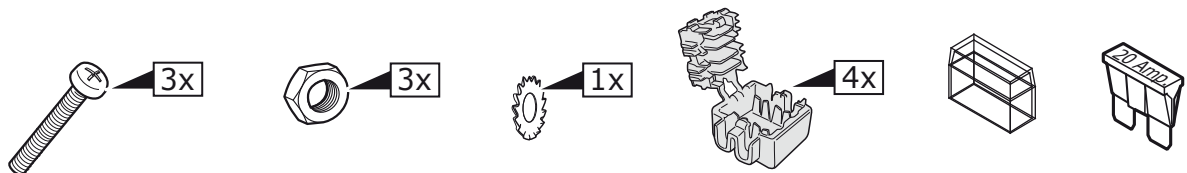
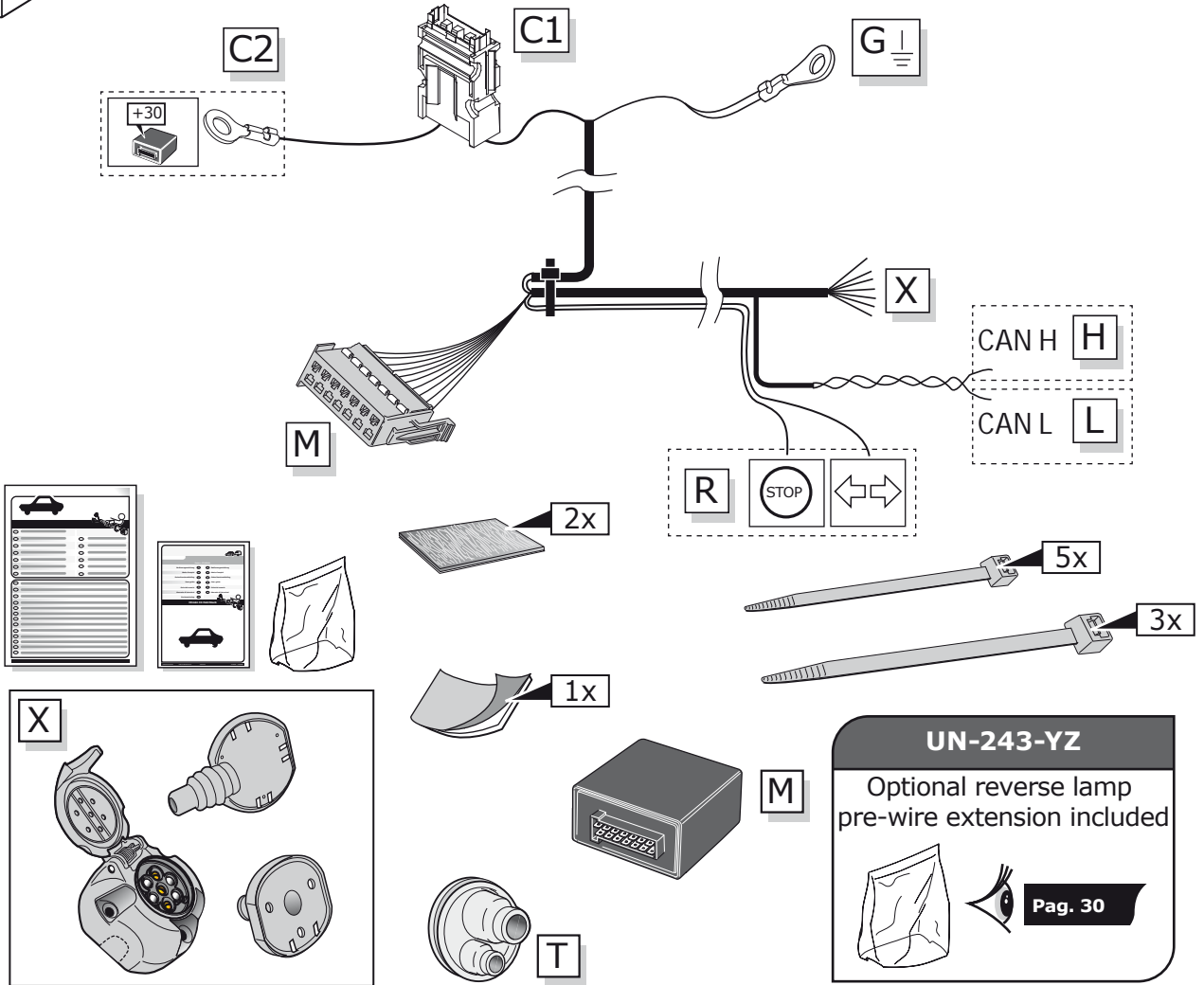
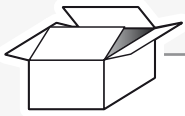

FIRST INQUIRE AT THE DEALER IF AN EXPANSION SET FOR A TOWING HOOK PLUS HEAT INSULATION (IN CONNECTION WITH COOLING) APPLIES TO YOUR VEHICLE.

**BMW 5 Series F10, F11
BMW 7 Series F01, F02**



Pag. 5

BMW X3 Series F25



Pag. 8

**BMW 1 Series E81, E82, E87, E88
BMW 3 Series E90, E91, E92, E93
BMW 5 Series E60, E61, F07
BMW 7 Series E65, E66
BMW X1 Series E84
BMW X5 Series E70
BMW X6 Series E71**

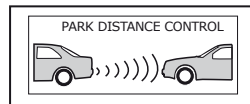

Pag. 11

**BMW 5 Series E60, E61, F07
BMW 7 Series E65, E66
BMW X1 Series E84
BMW X5 Series E70
BMW X6 Series E71**

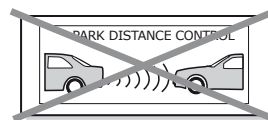

Pag. 14

**BMW 1 Series E81, E82, E87, E88
BMW 3 Series E90, E91, E92, E93**

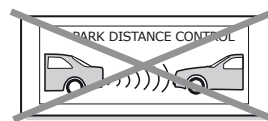

Pag. 17

BMW 1 Series F20, F21



Pag. 20

BMW 3 Series F30, F31, F34



Pag. 23

BMW 5 Series F10, F11
BMW 7 Series F01, F02

ROUTING

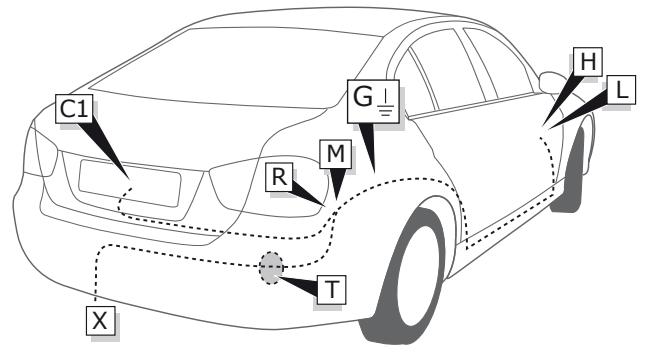

1

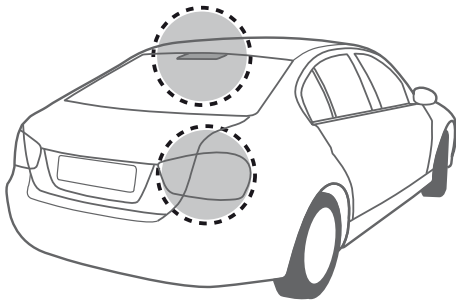
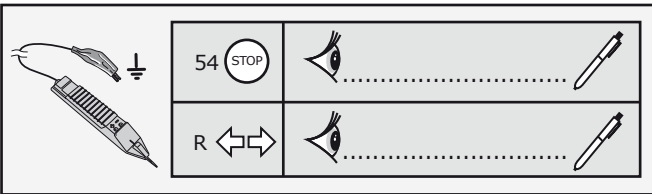

2

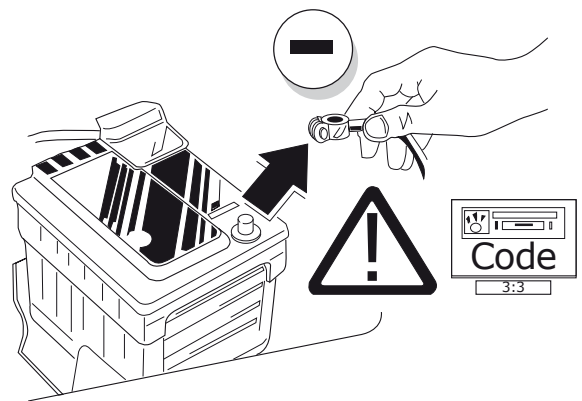

3

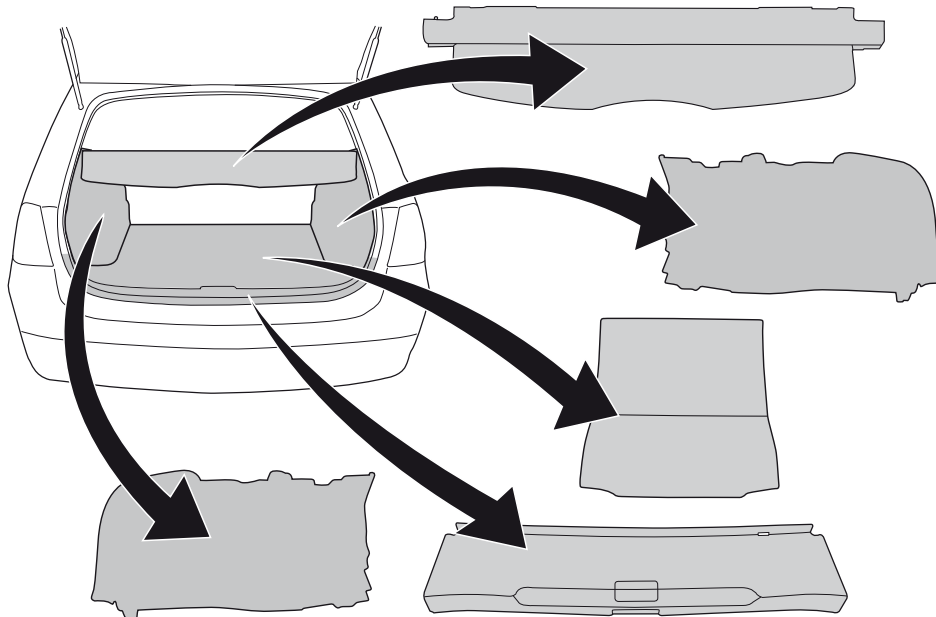

4

INFO

X

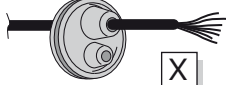

2

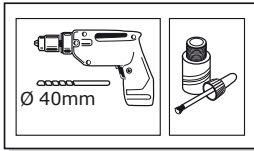

1

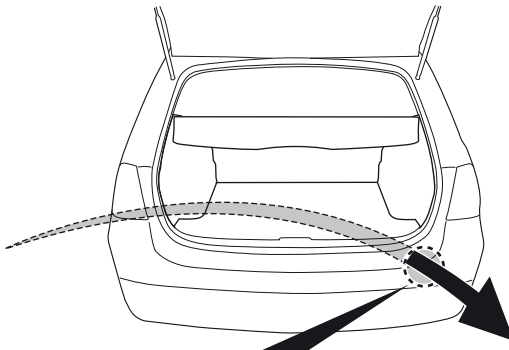

INFO

SOCKET CONNECTION



Pag. 28

5

1

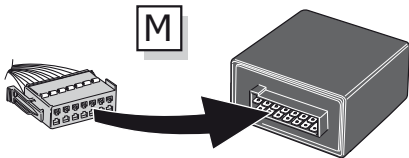

2

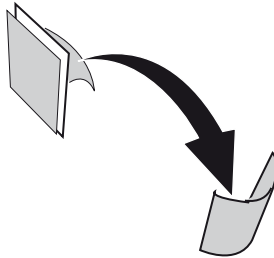

3

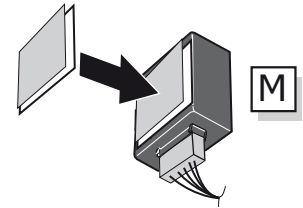

4

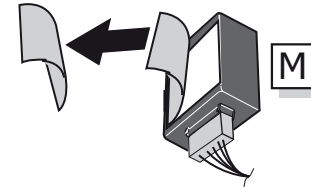

6

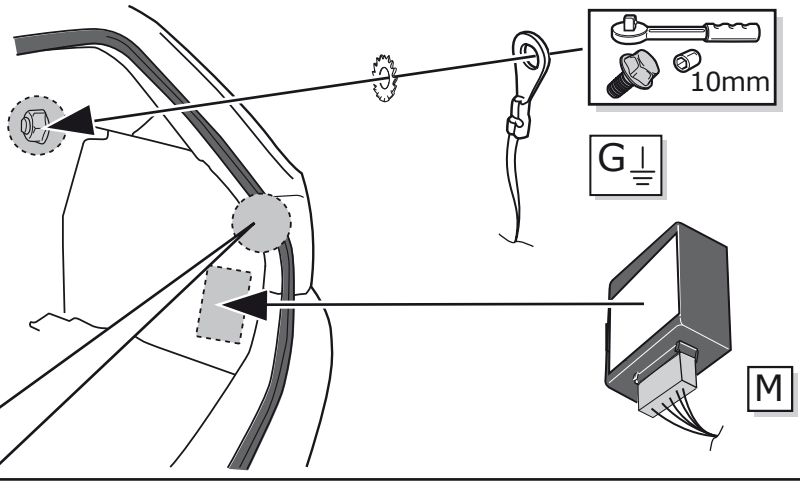
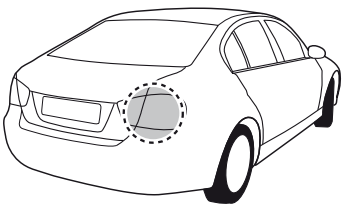

INFO

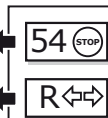
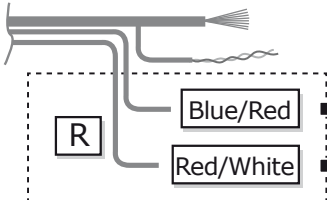

Pag. 5

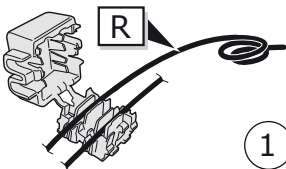
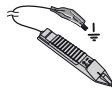

1

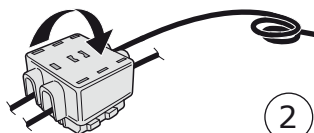

2

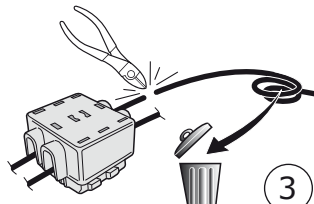

3

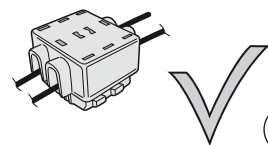

4

7

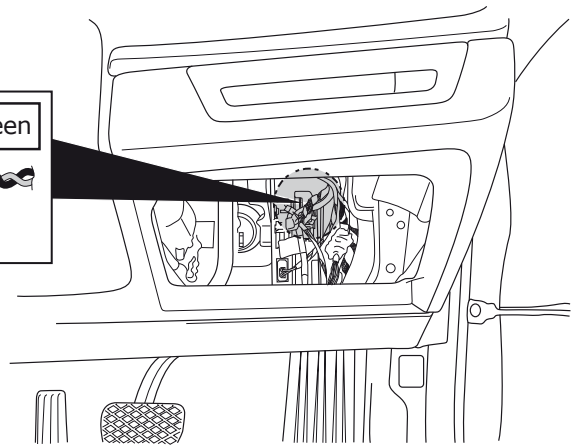
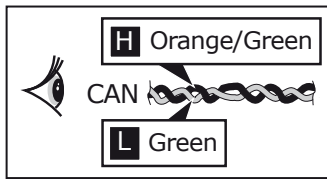
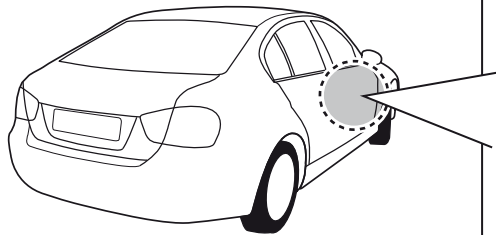

8

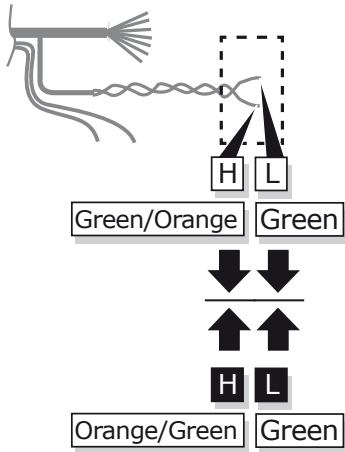

<p>H Green/Orange L Orange/Green</p>	<p>L Green L Green</p>	
<p>H Green/Orange H Orange/Green</p>	<p>L Green L Green</p>	
<p>INFO</p>		

9

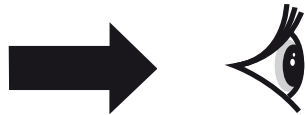

Pag. 26

BMW X3 Series F25

ROUTING

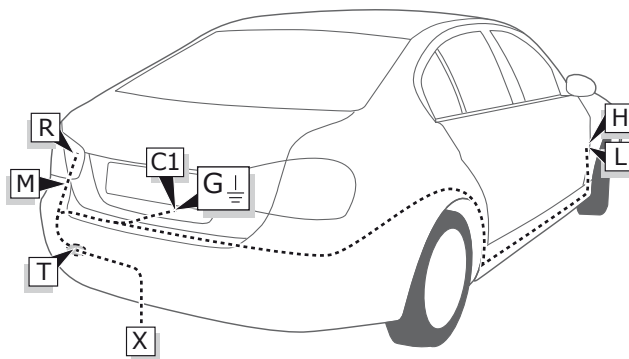

10

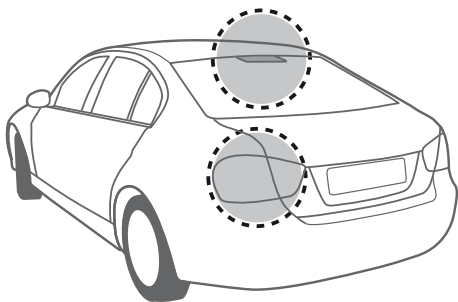
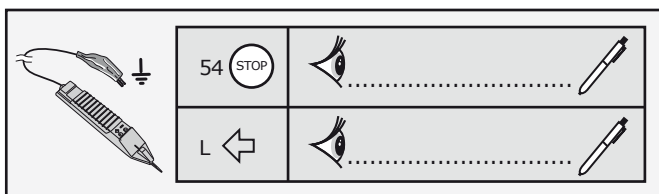

11

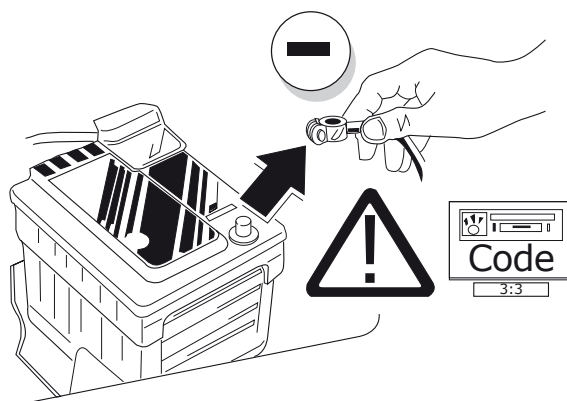

12

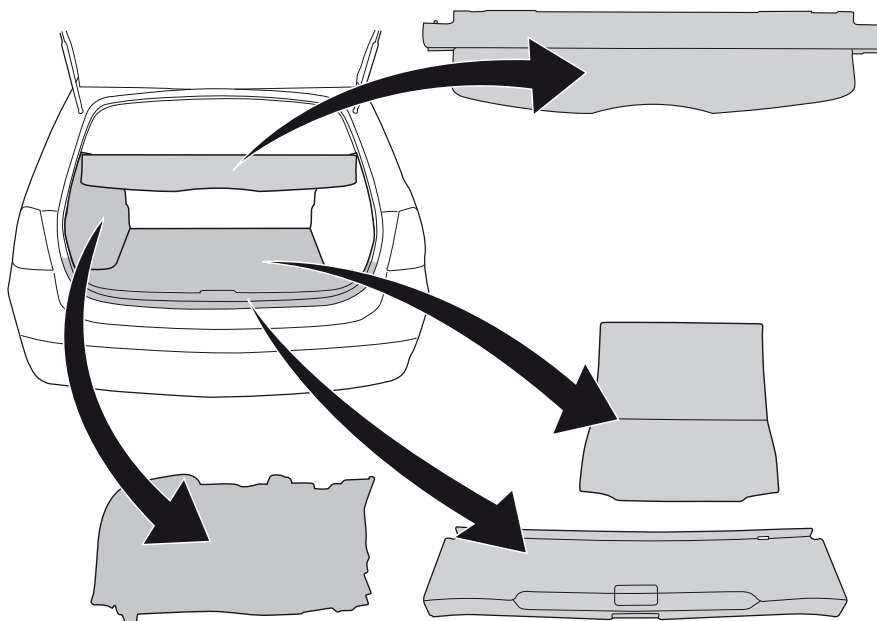

13

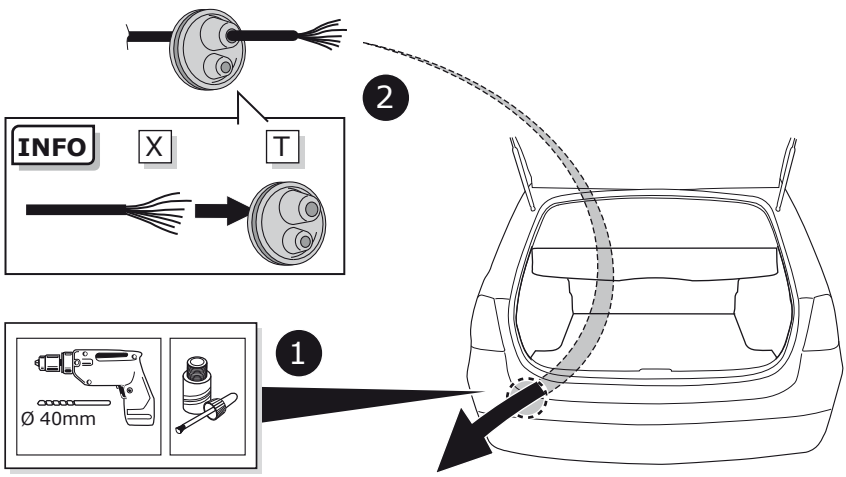

INFO

SOCKET CONNECTION



Pag. 28

14

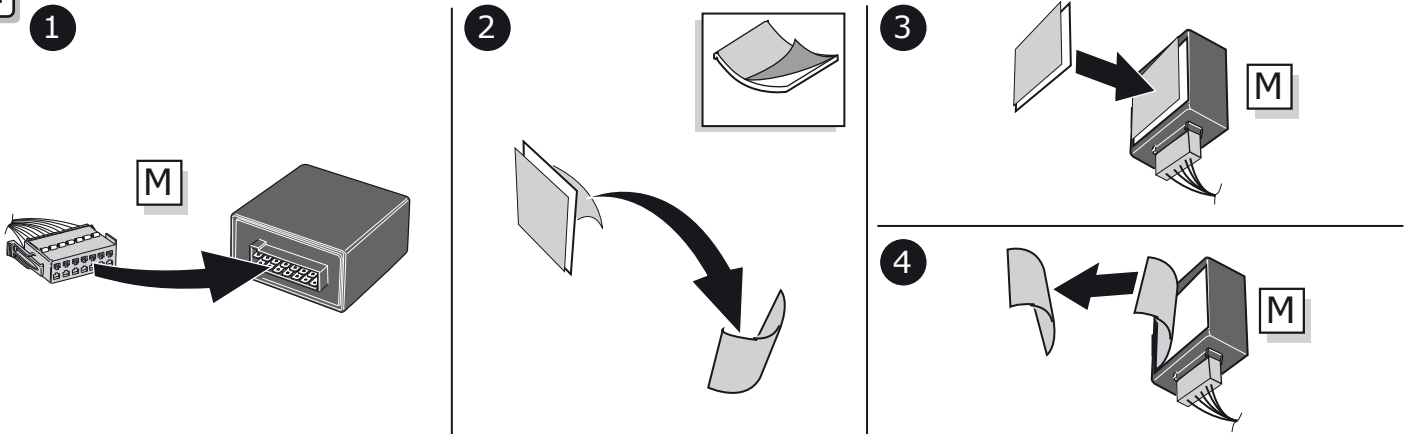

15

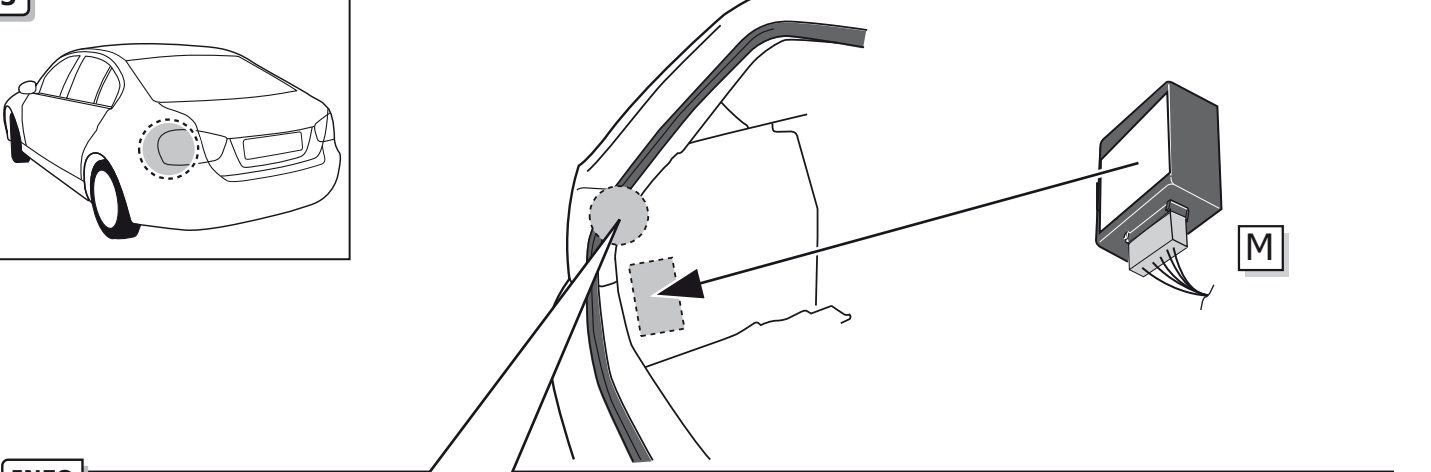

INFO

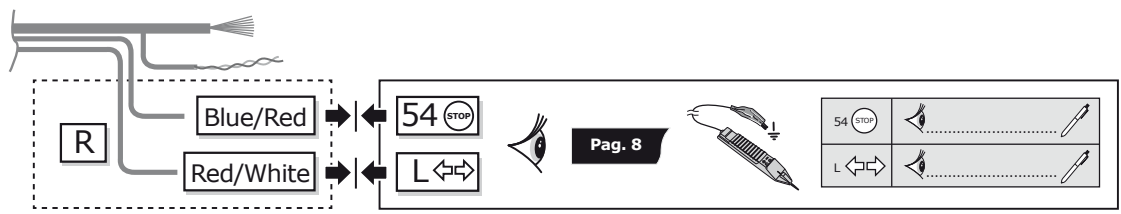

Pag. 8

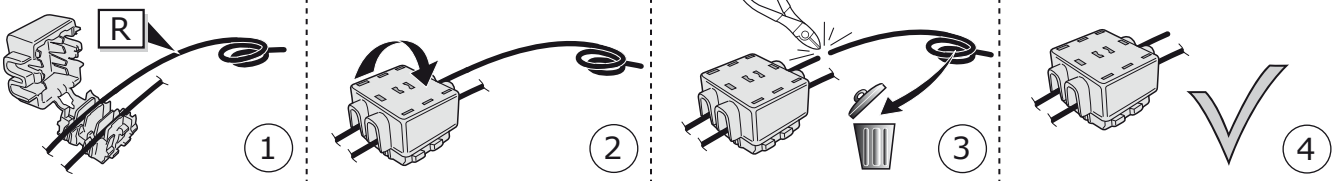
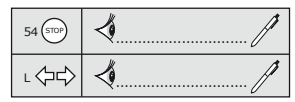

16

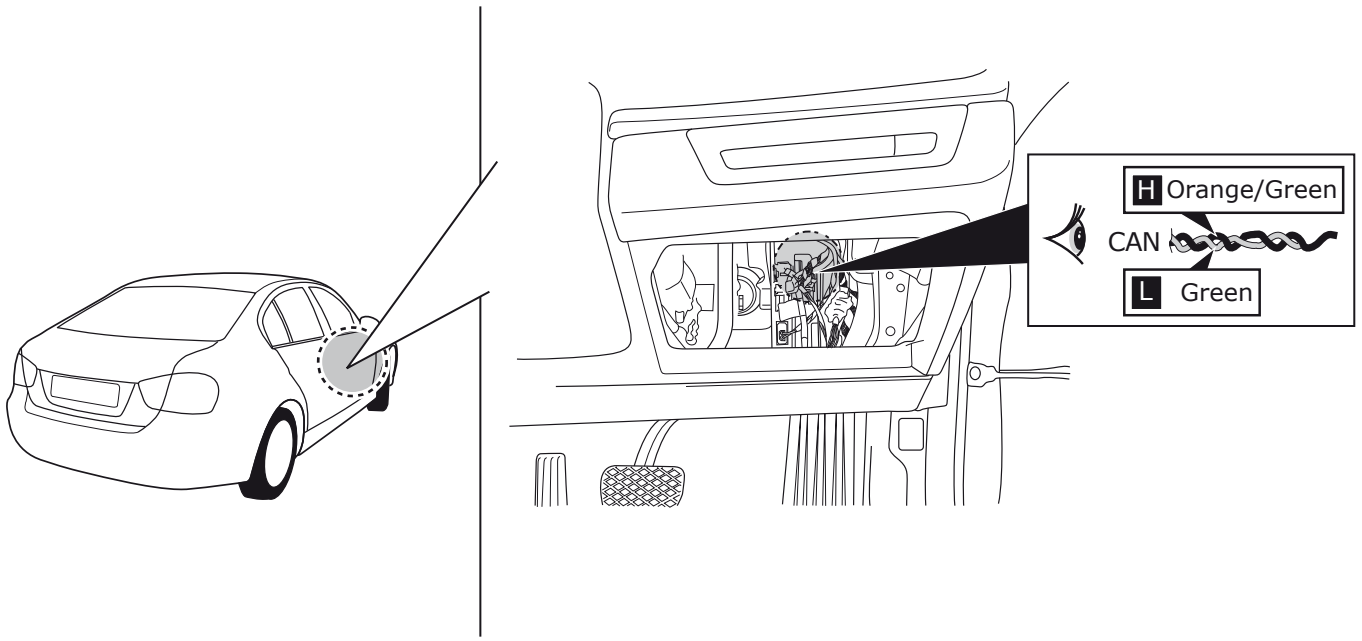

17

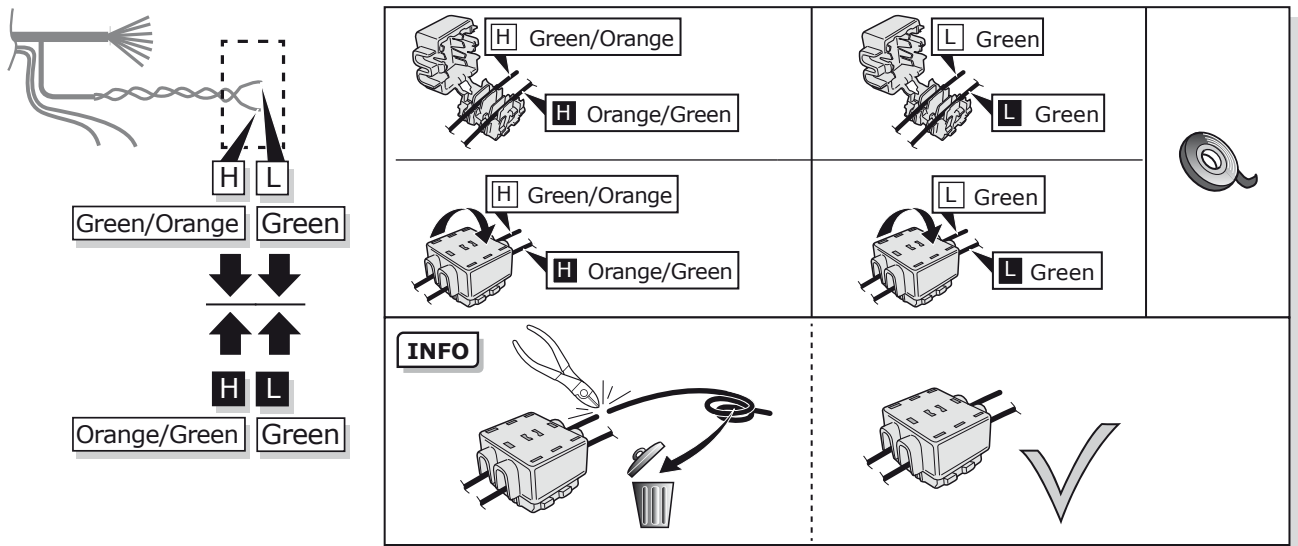

18

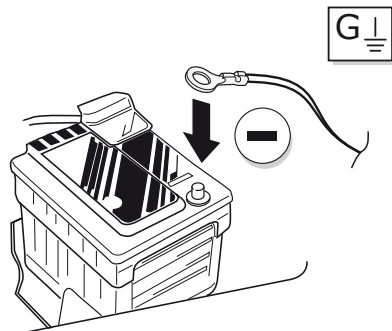

19



BMW 1 Series E81, E82, E87, E88
BMW 3 Series E90, E91, E92, E93
BMW 5 Series E60, E61, F07
BMW 7 Series E65, E66
BMW X1 Series E84
BMW X5 Series E70
BMW X6 Series E71

ROUTING

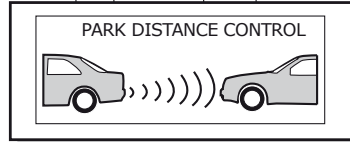
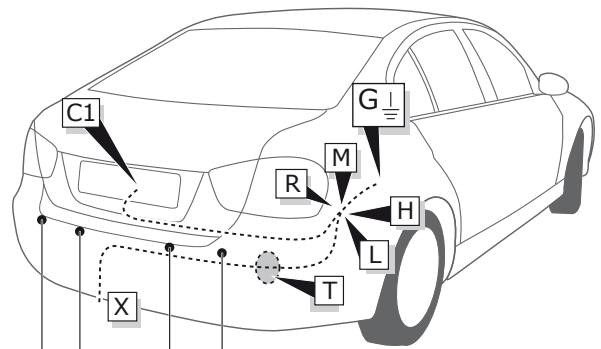

20

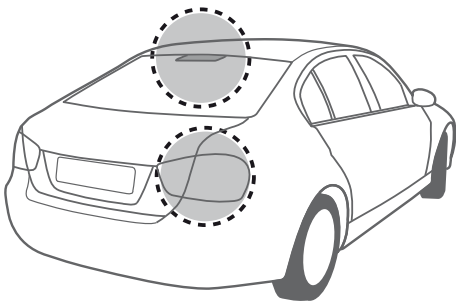
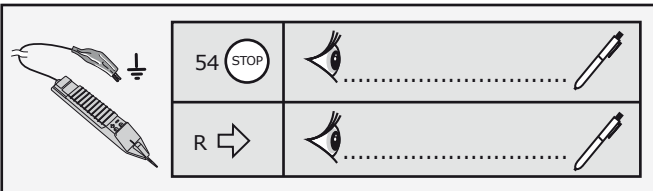

21

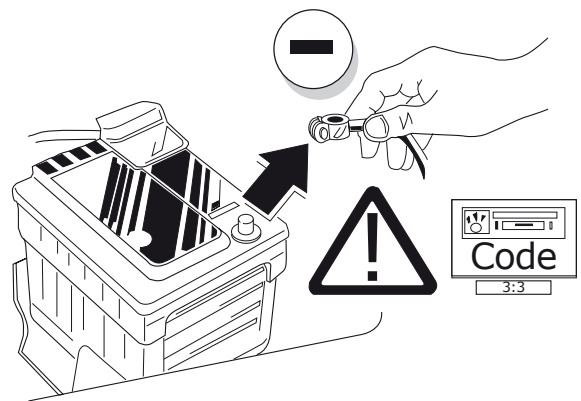

22

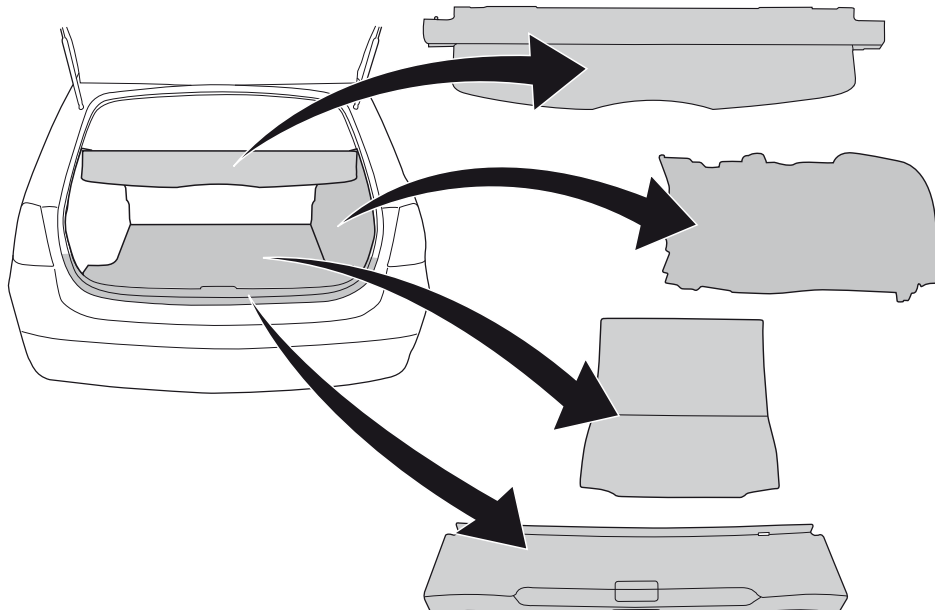

23

INFO

X

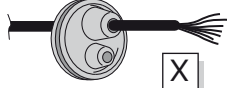

2

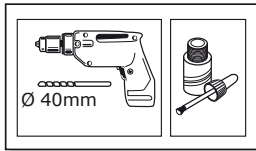

1

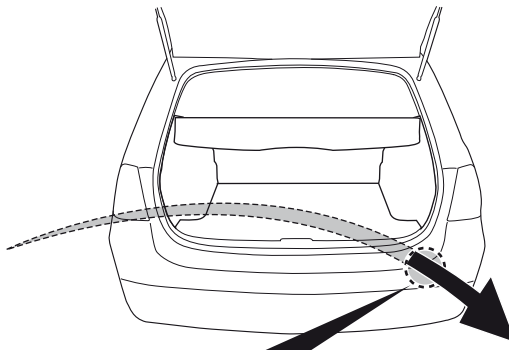

INFO

SOCKET CONNECTION



Pag. 28

24

1

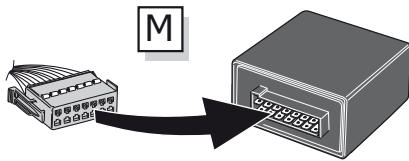

2

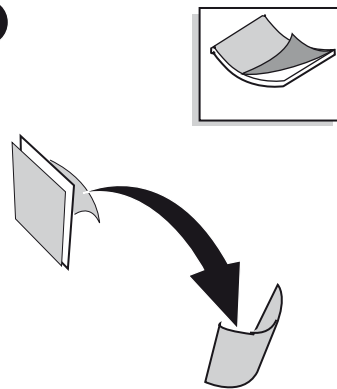

3

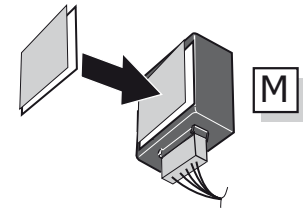

4

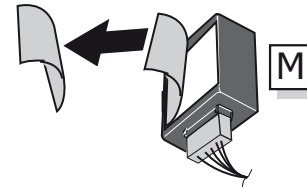

25

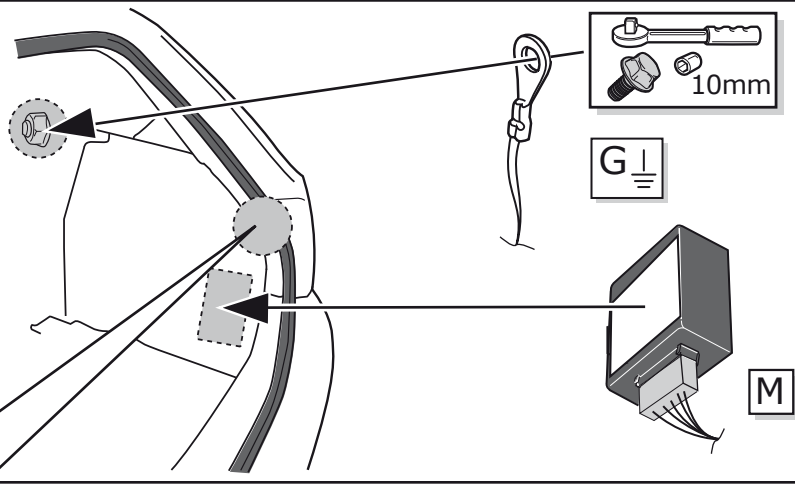
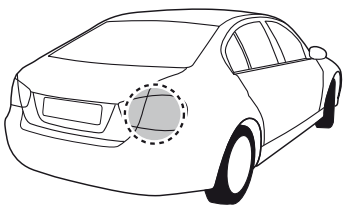

INFO

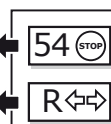
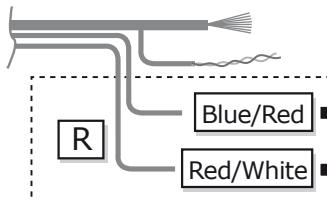

Pag. 11

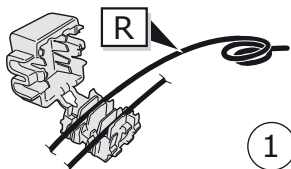
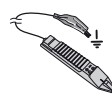

1

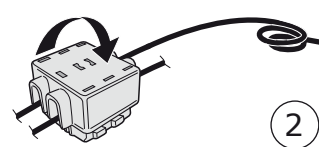

2

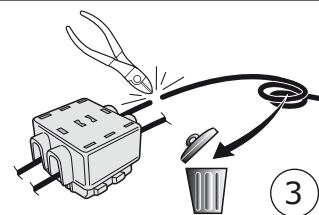

3

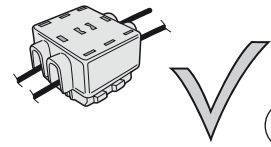

4

26

OPTION 1: E60 / E61

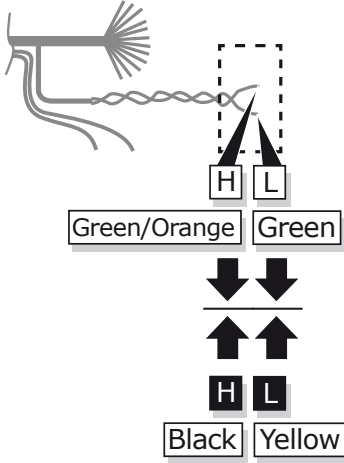
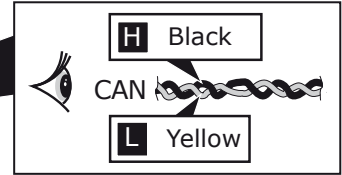
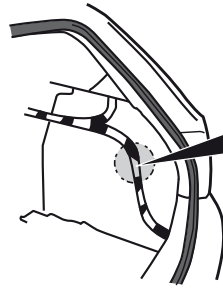
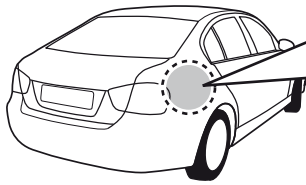

<p>INFO</p>		

27

OPTION 2: Other models

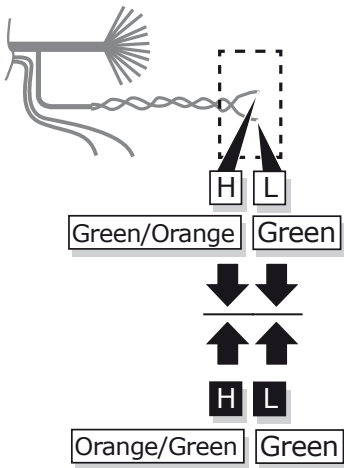
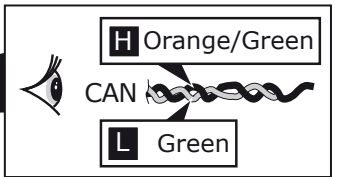
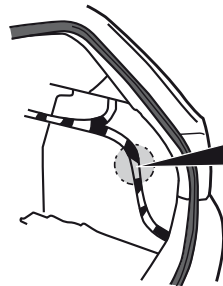
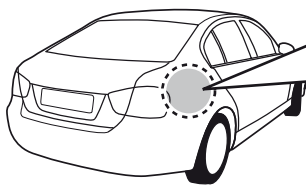

<p>INFO</p>		

28



Pag. 26

ROUTING

BMW 5 Series E60, E61, F07
BMW 7 Series E65, E66
BMW X1 Series E84
BMW X5 Series E70
BMW X6 Series E71

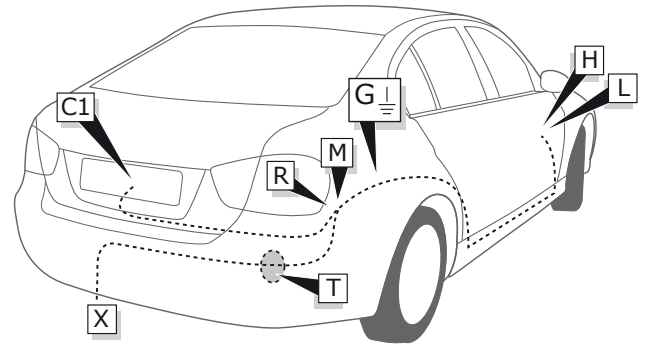

29

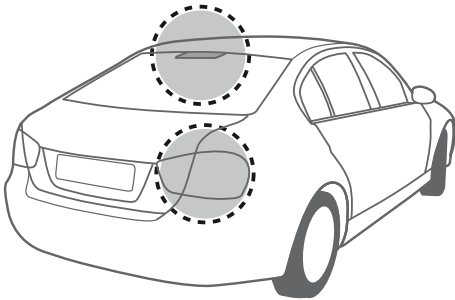
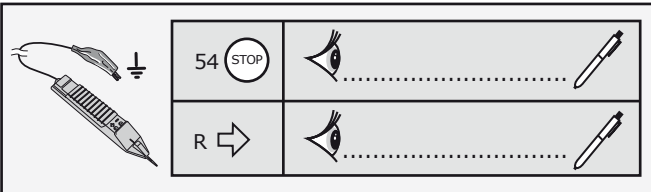

30

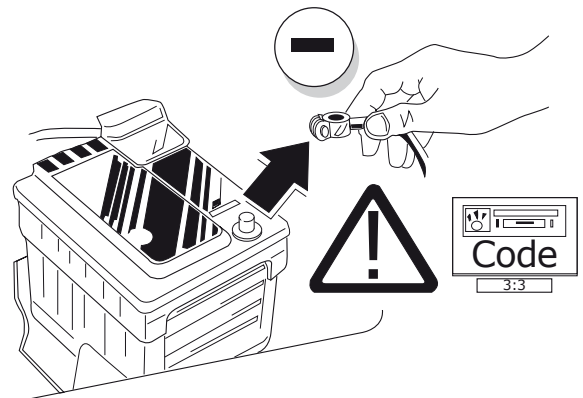

31

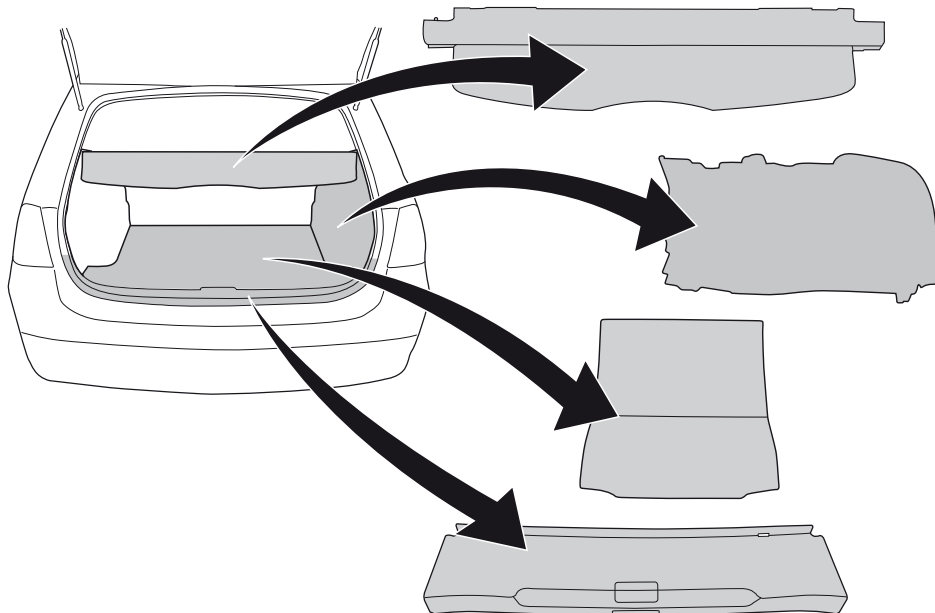

32

INFO

X



2

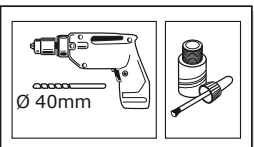

Ø 40mm

1

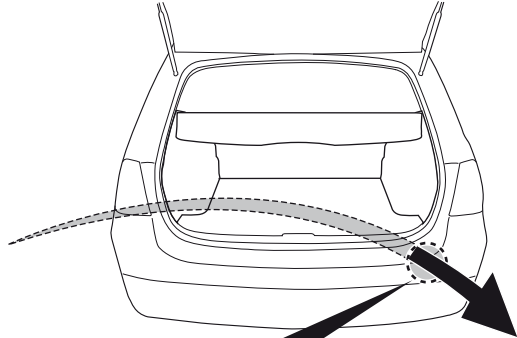

INFO

SOCKET CONNECTION



Pag. 28

33

1

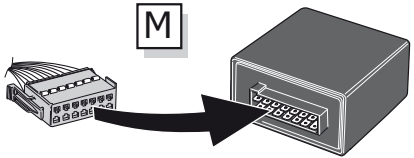

2

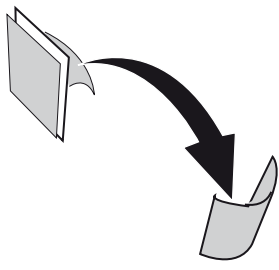

3

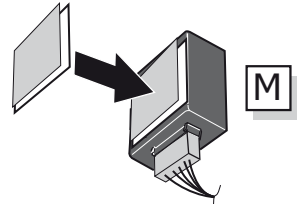

4

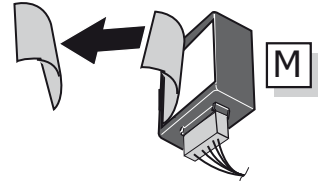

34

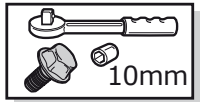
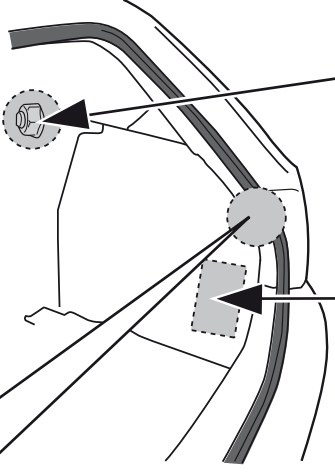
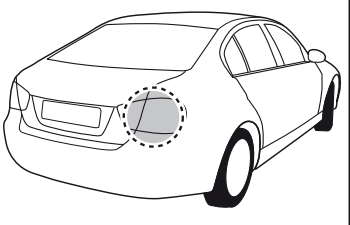

G I

M

INFO

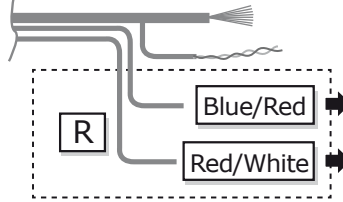

R

Blue/Red

Red/White

54 STOP

R ↔



Pag. 14

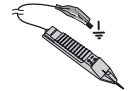

54 STOP

R ↔

R ↔

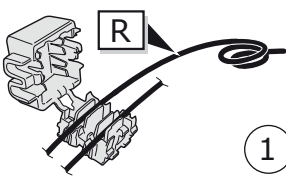

1

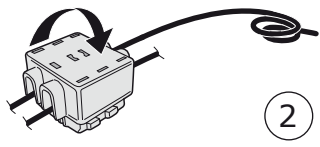

2

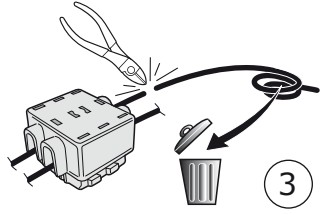

3

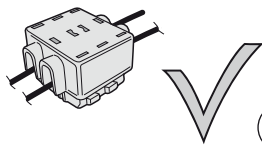

4

35

OPTION 1: E60 / E61

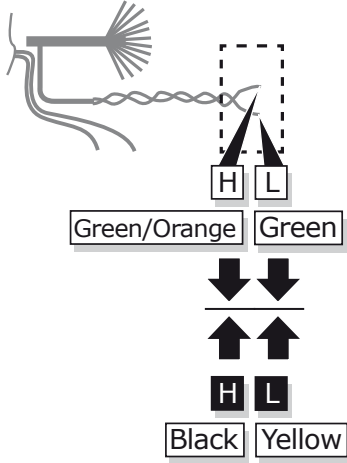
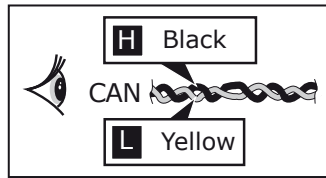
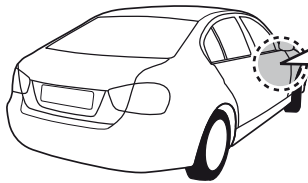

INFO		

36

OPTION 2: Other models

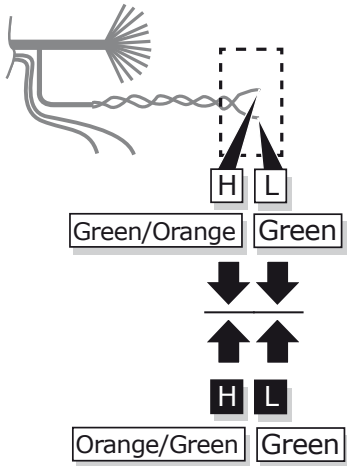
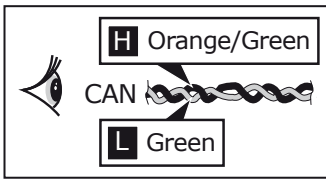
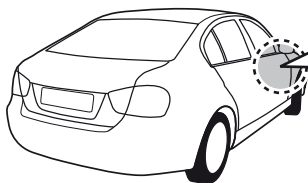

INFO		

37



Pag. 26

ROUTING

BMW 1 Series E81, E82, E87, E88
BMW 3 Series E90, E91, E92, E93

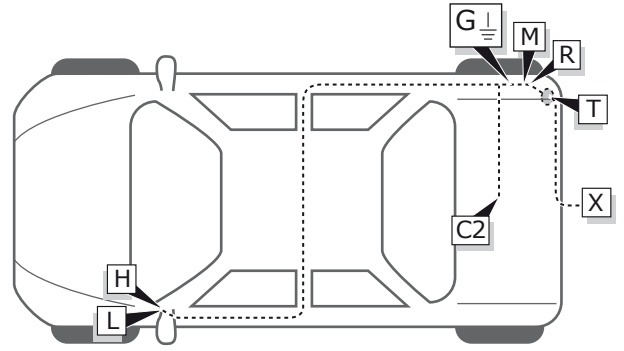

38

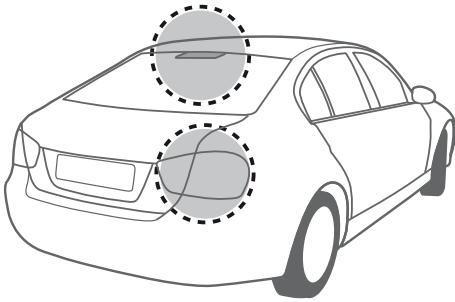
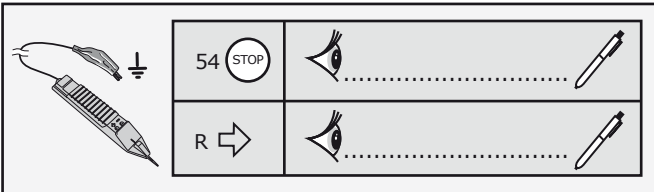

39

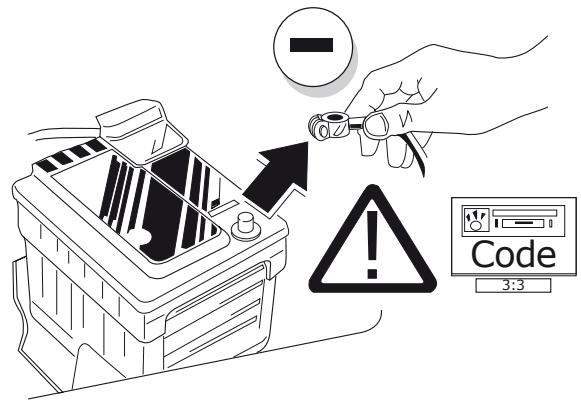

40

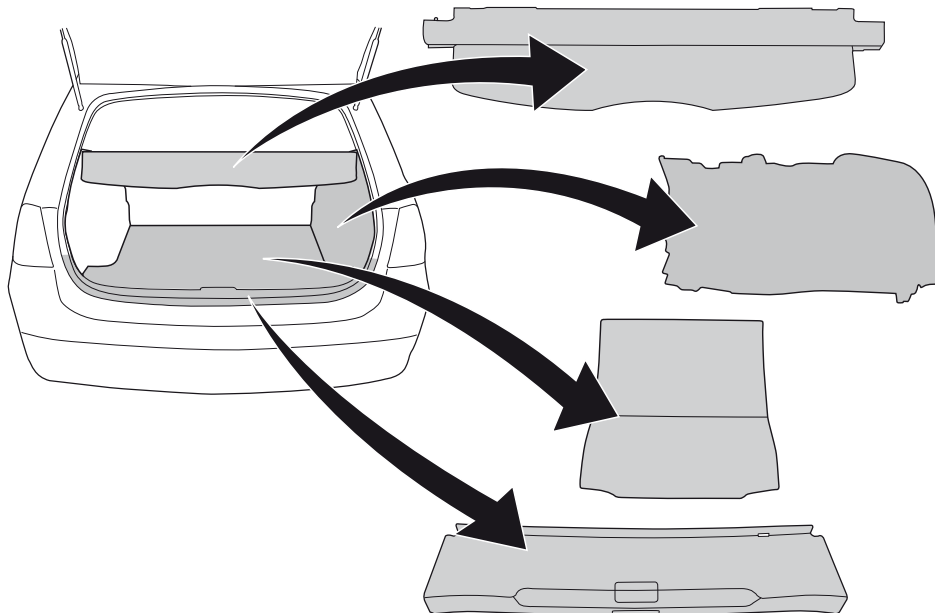

41

INFO

X

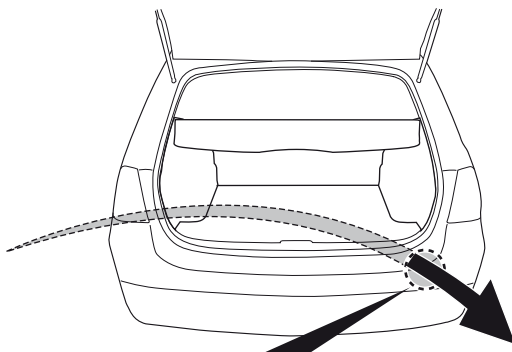
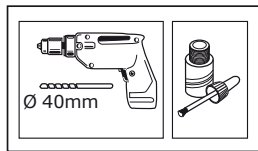
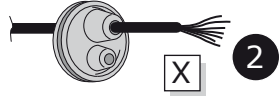

1

INFO

SOCKET CONNECTION



Pag. 28

42

1

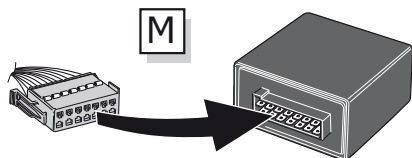

2

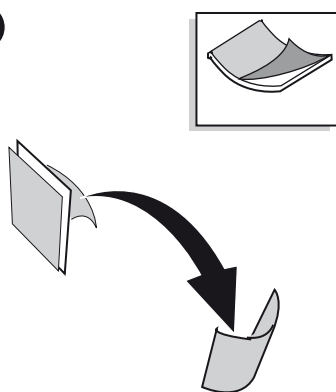

3

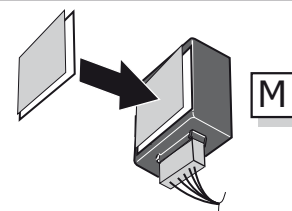

4

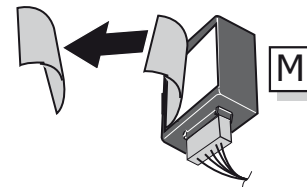

43

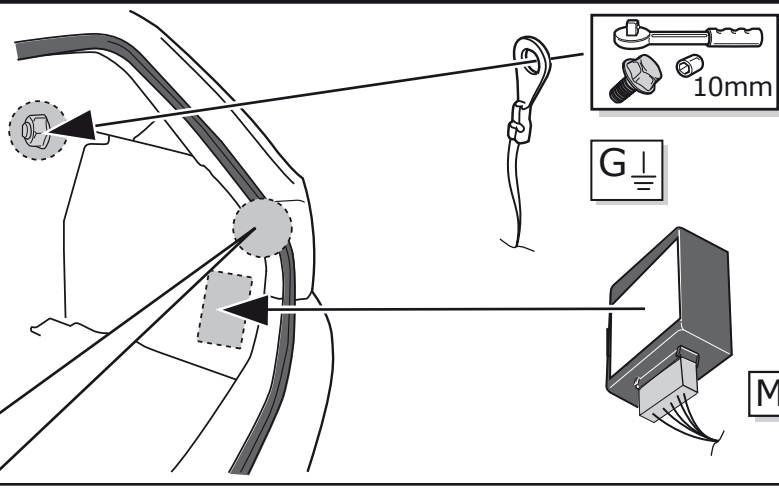
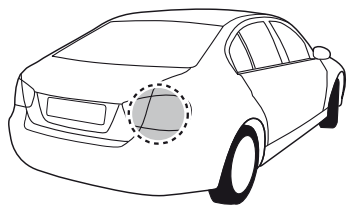

INFO

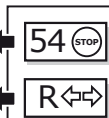
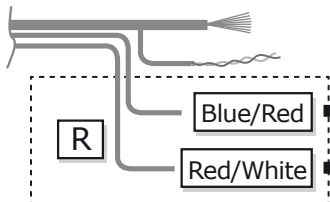

Pag. 17

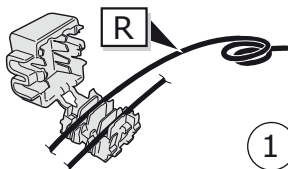
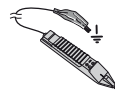

1

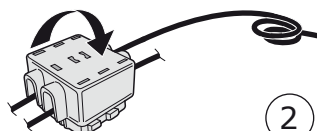

2

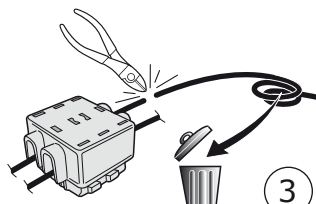

3

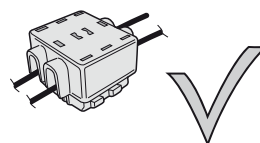

4

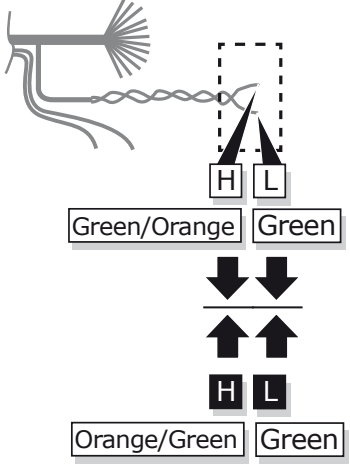
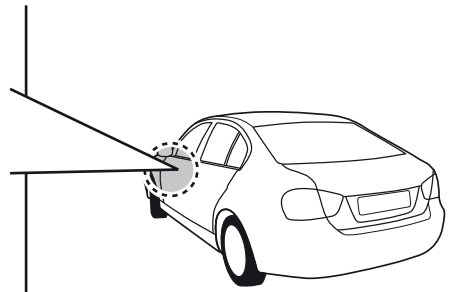
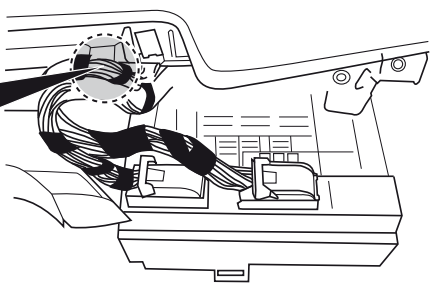
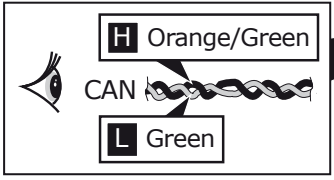

<p>H Green/Orange L Orange/Green</p>	<p>L Green</p>	
<p>H Green/Orange L Orange/Green</p>	<p>L Green</p>	
<p>INFO</p>		



Pag. 26

BMW 1 Series F20, F21

INFO



without PDC cut off function

PARK DISTANCE CONTROL



PARK DISTANCE CONTROL



ROUTING

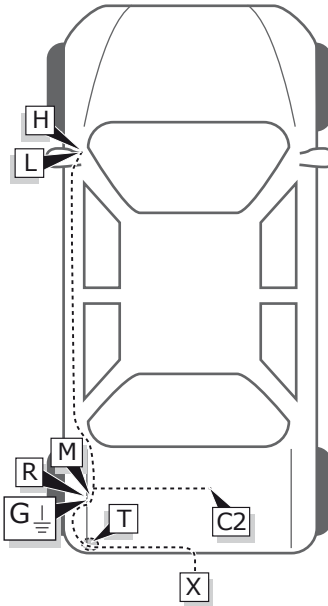

46

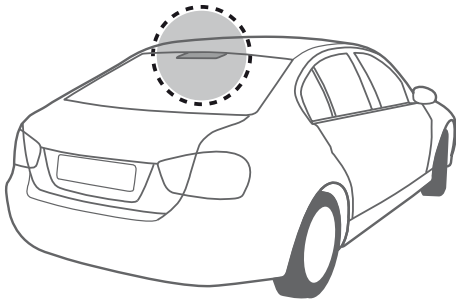
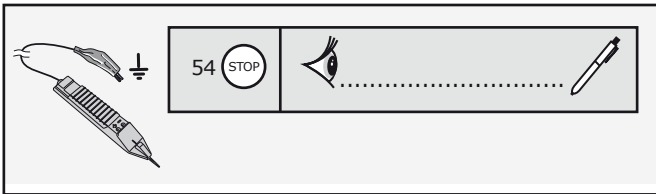

47

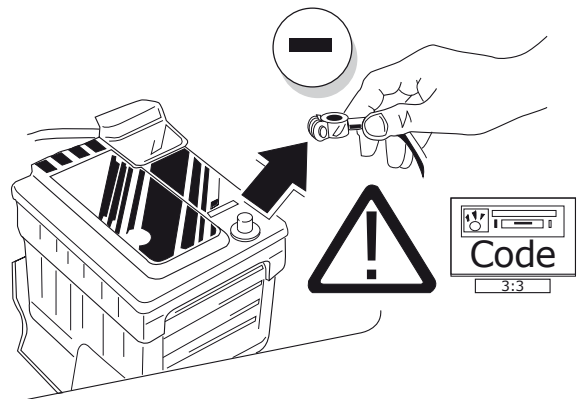

48

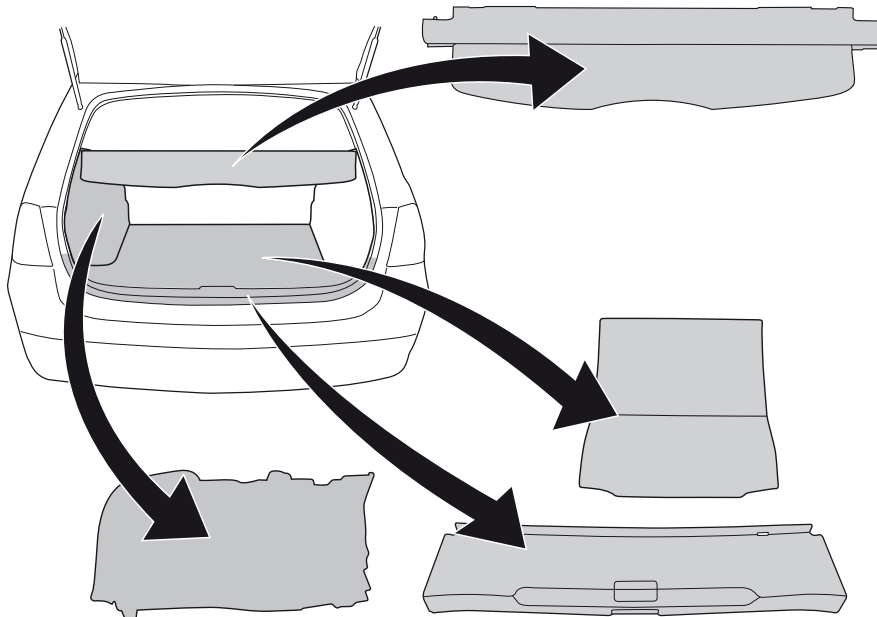

49

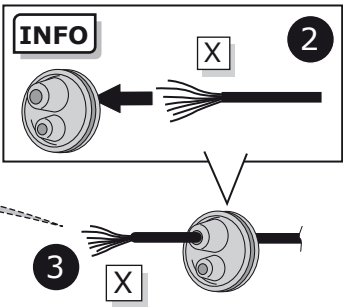
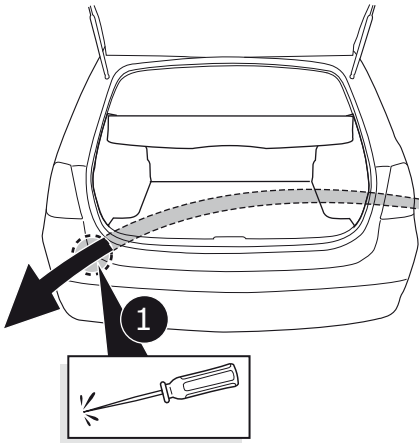

INFO

SOCKET CONNECTION



Pag. 28

50

1

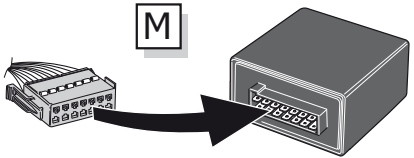

2

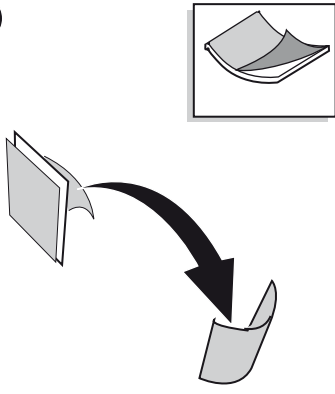

3

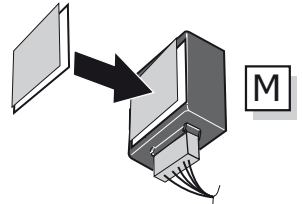

4

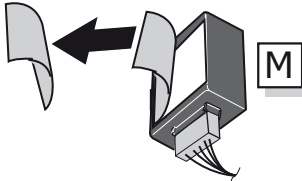

51

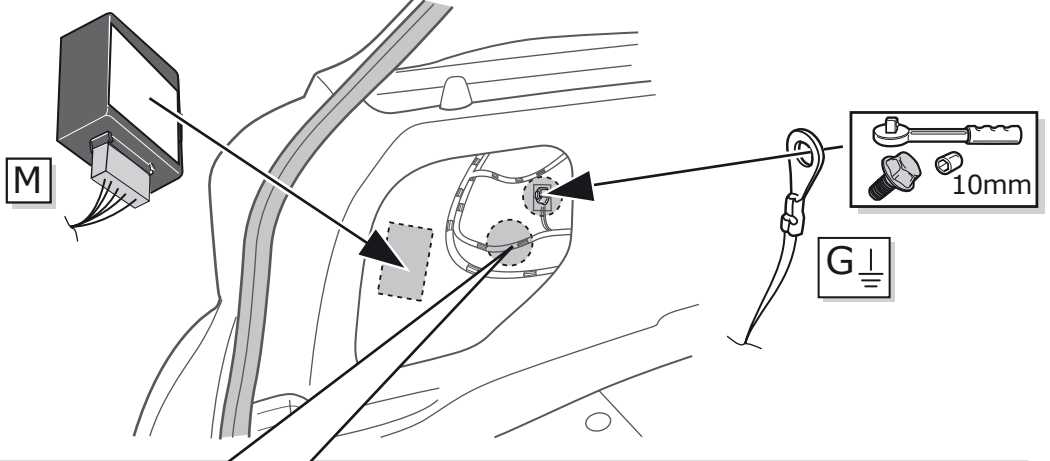
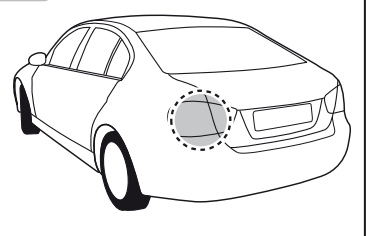

INFO

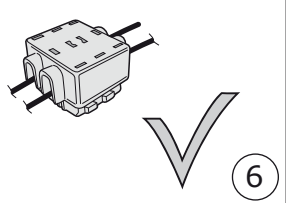
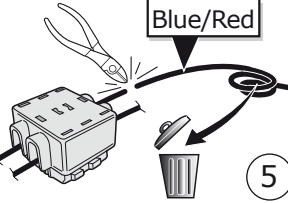
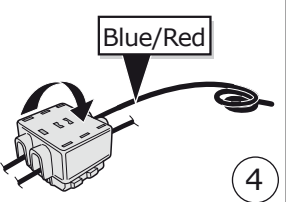
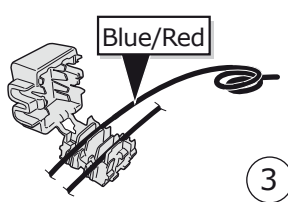
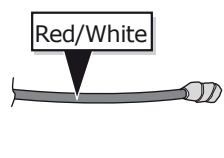
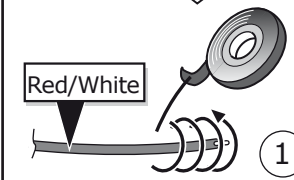
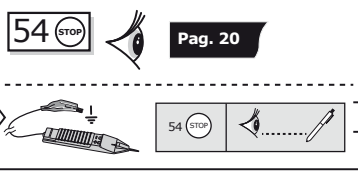

52

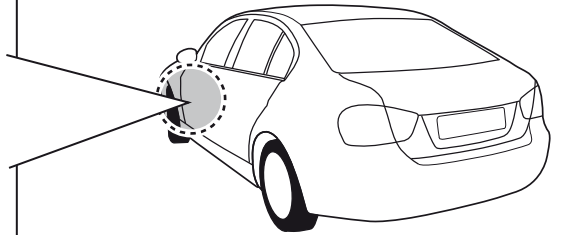
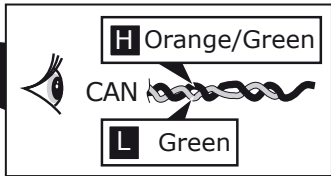
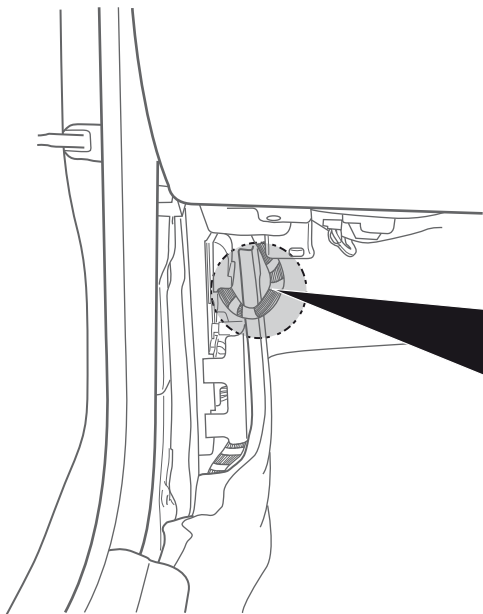

53

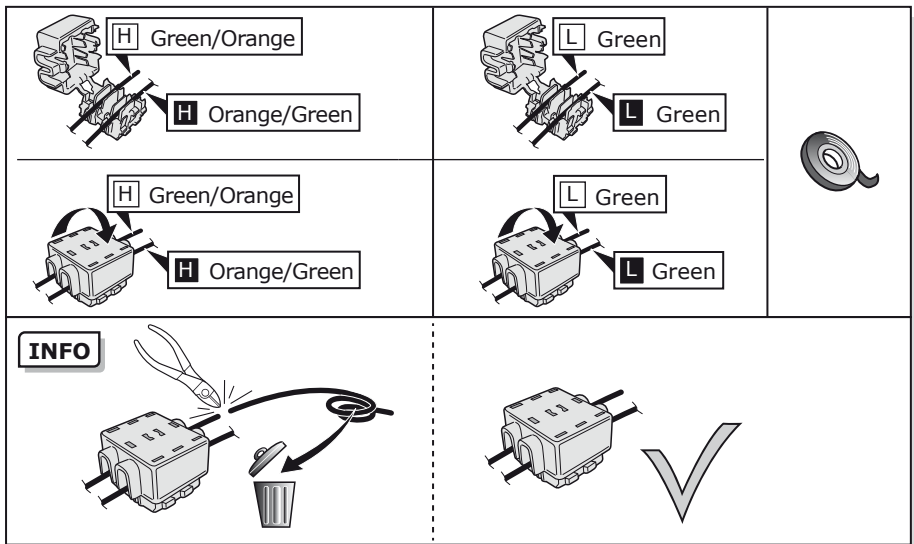
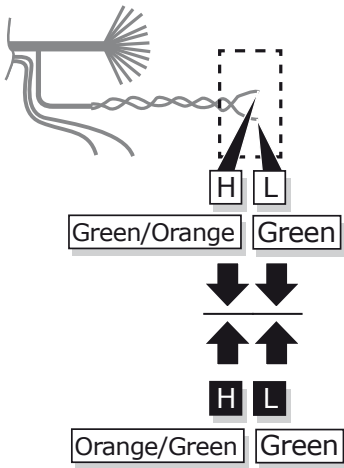

54



BMW 3 Series F30, F31, F34

ROUTING

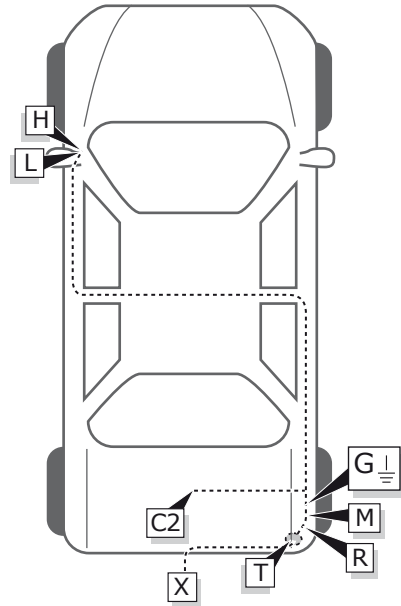

55

		54 STOP	
	R		

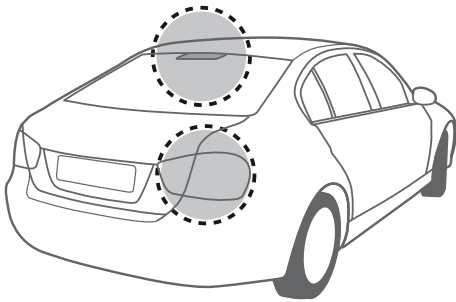

56

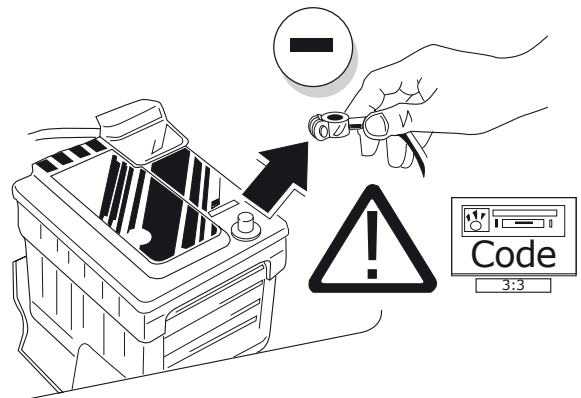

57

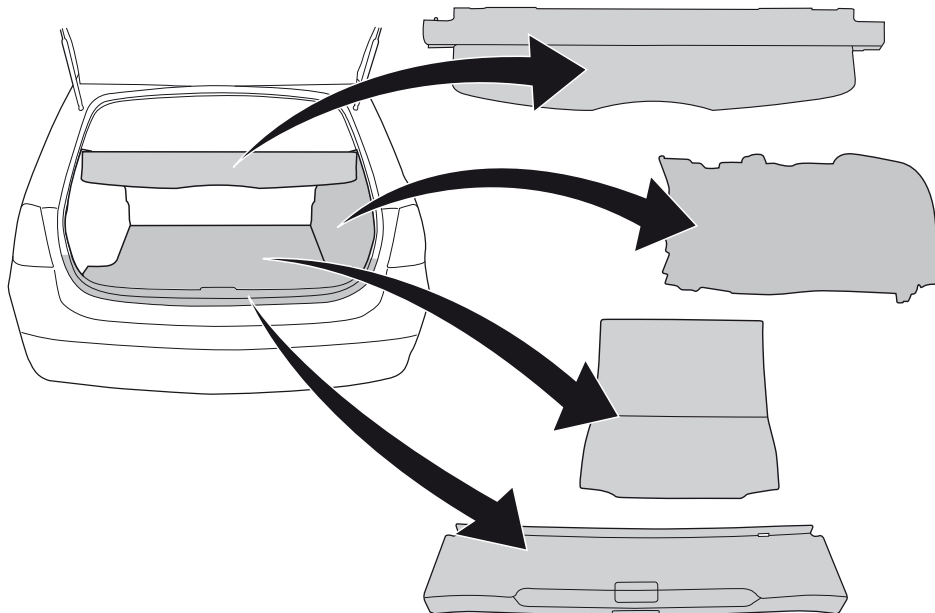

58

INFO

X

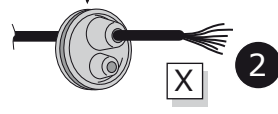
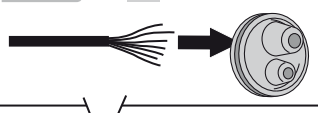

X

2

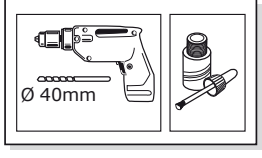
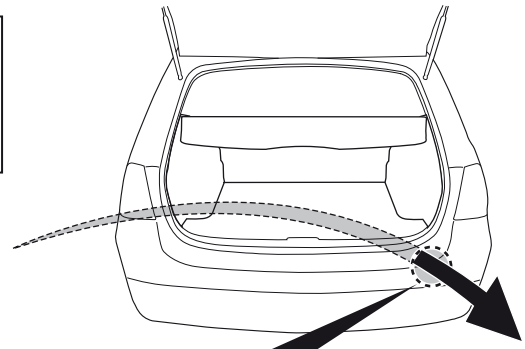

1

INFO

SOCKET CONNECTION



Pag. 28

59

1

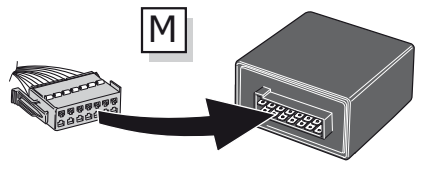

2

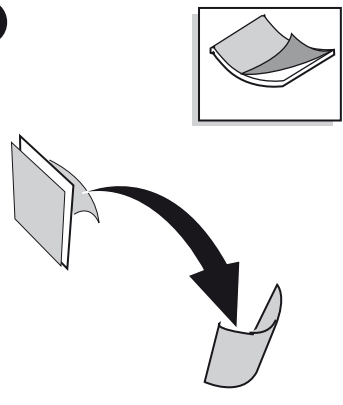

3

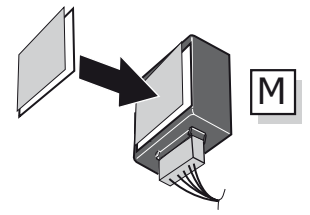

4

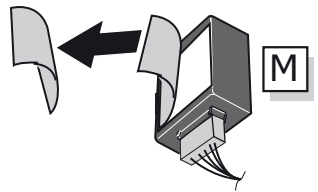

60

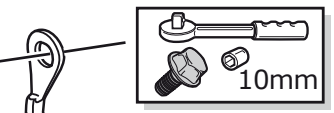
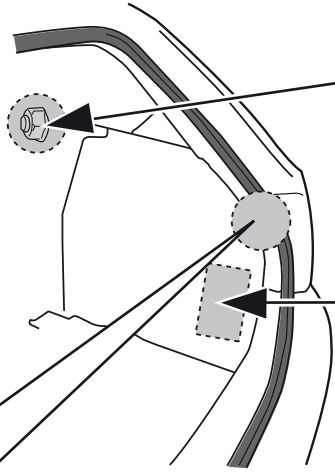
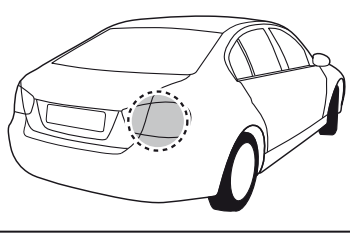

G I

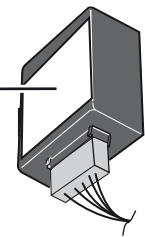

M

INFO

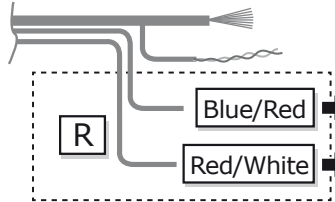

R

Blue/Red

Red/White

54 STOP

R ↔



Pag. 23

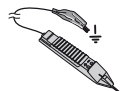

54 STOP

R ↔

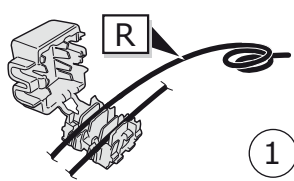

R

1

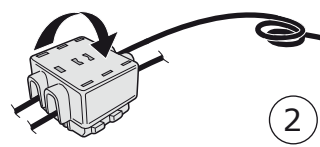

2

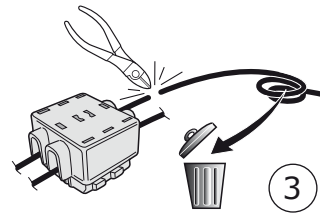

3

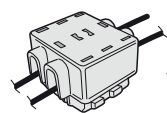

4



61

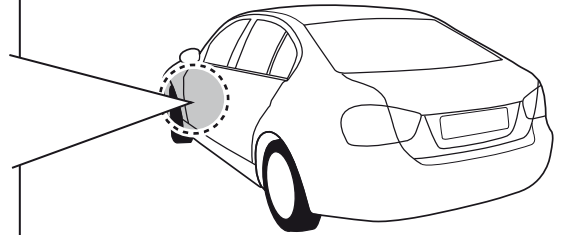
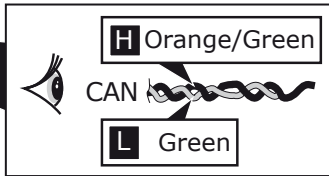
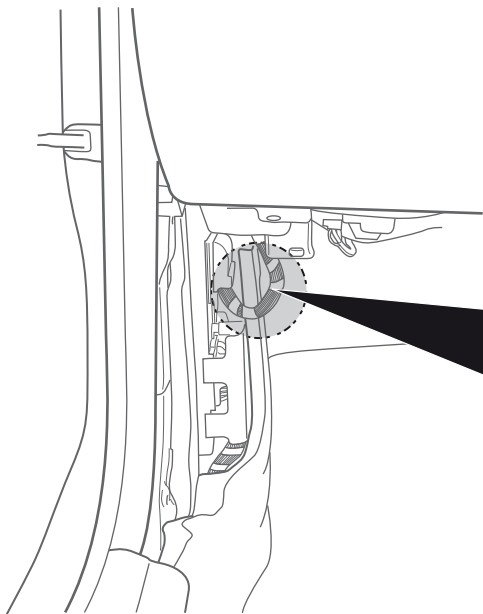

62

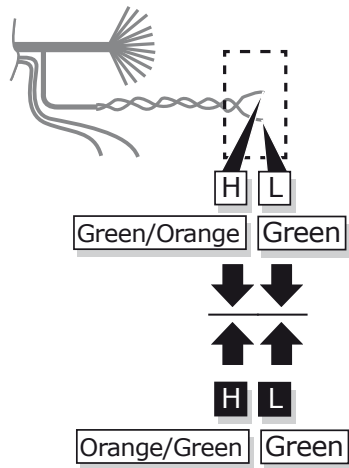

<p>H Green/Orange L Orange/Green</p>	<p>L Green L Green</p>	
<p>H Green/Orange H Orange/Green</p>	<p>L Green L Green</p>	
<p>INFO</p>		

63



64

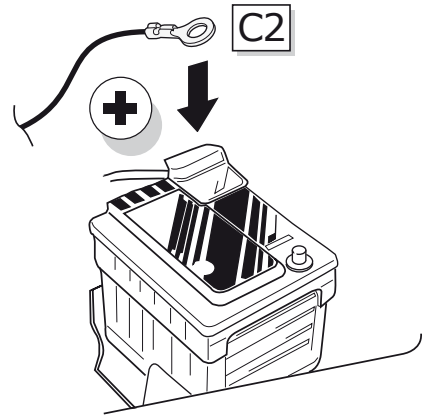
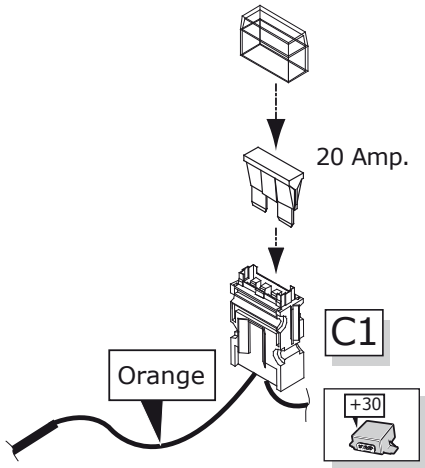

65

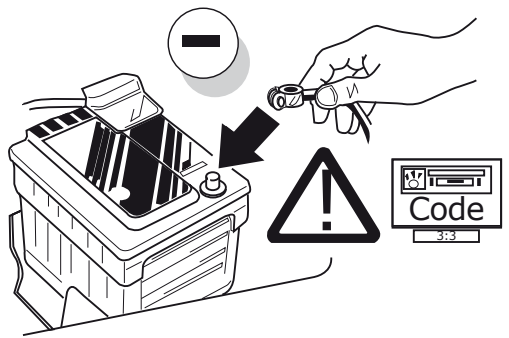

66

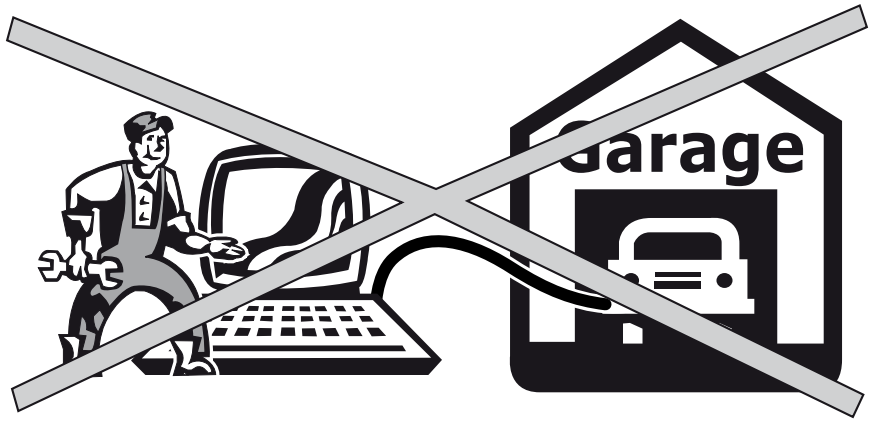

! TEST ALL THE CIRCUITS WITH A TEST DEVICE WITH THE CORRECT POWER LOAD FOR EACH FUNCTION. A TEST DEVICE WITH LED'S CANNOT BE USED FOR THIS PURPOSE.

INFO

REINSTALL TRIM.

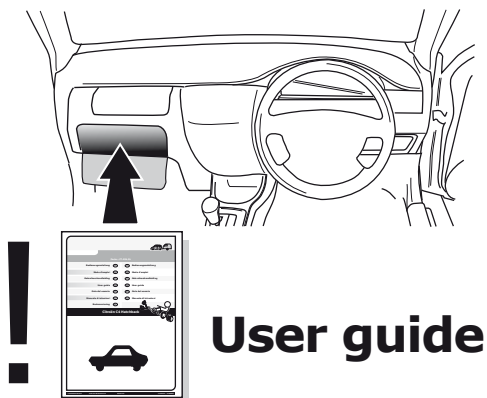

INFO

SOCKET CONNECTION

DIN/ISO 1724											
	1/L	2	3/31		4/R		5/58-R		6/54		7/58-L
Pmax	21W	21W		21W	42W	3x21W	42W				
Colour	Yellow	Blue	White	Green	Brown	Red	Black				

INFO SOCKET CONNECTION

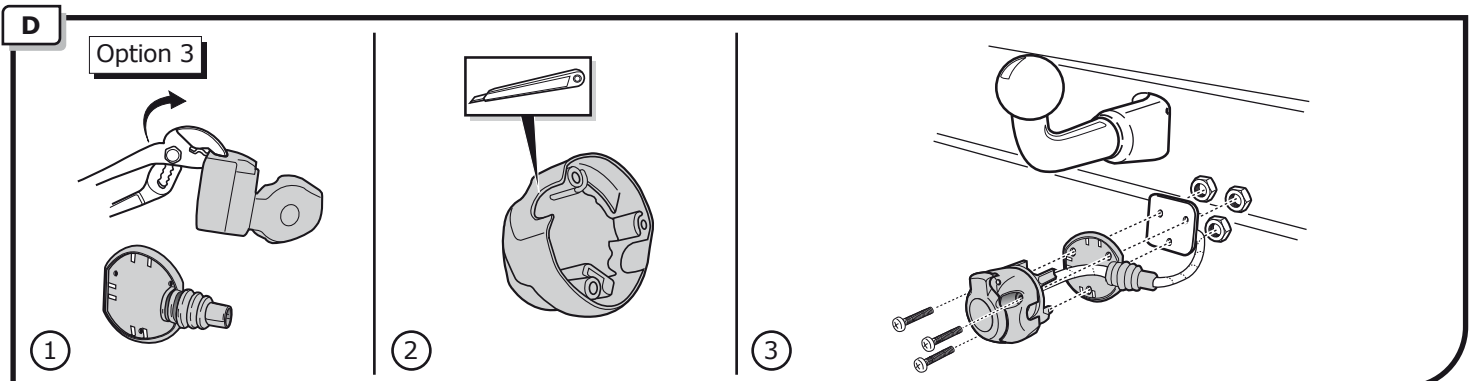
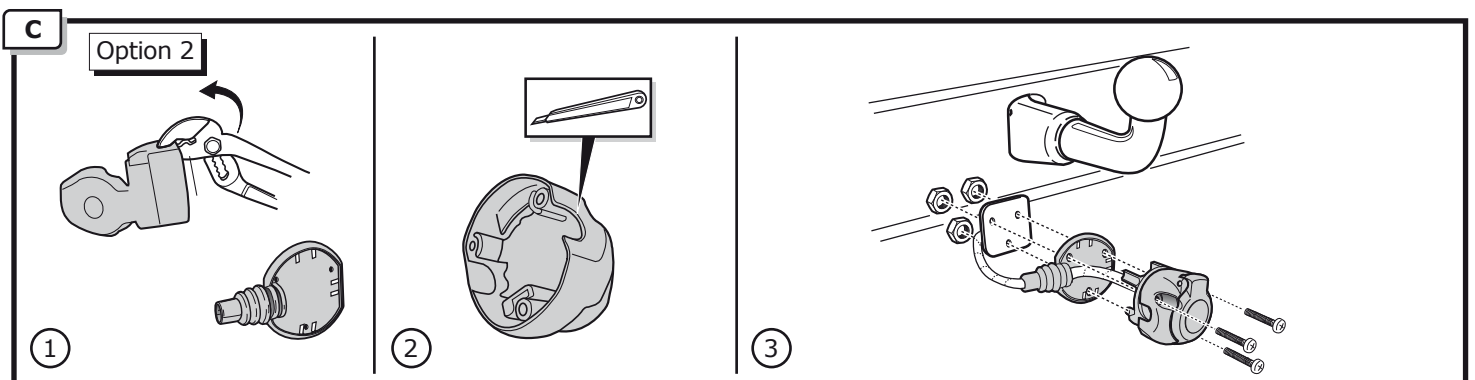
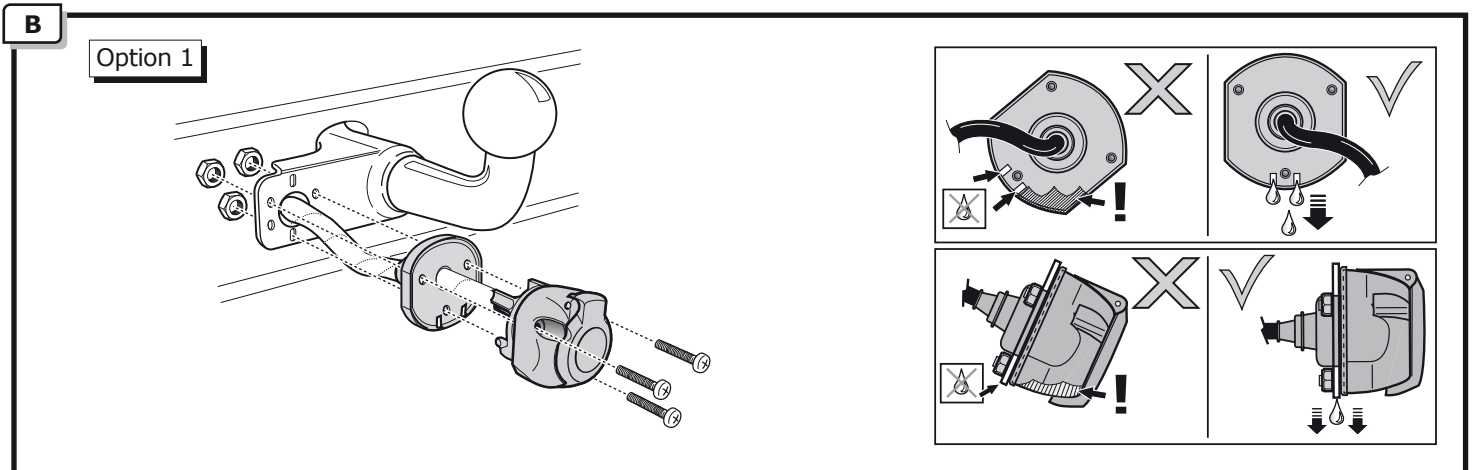
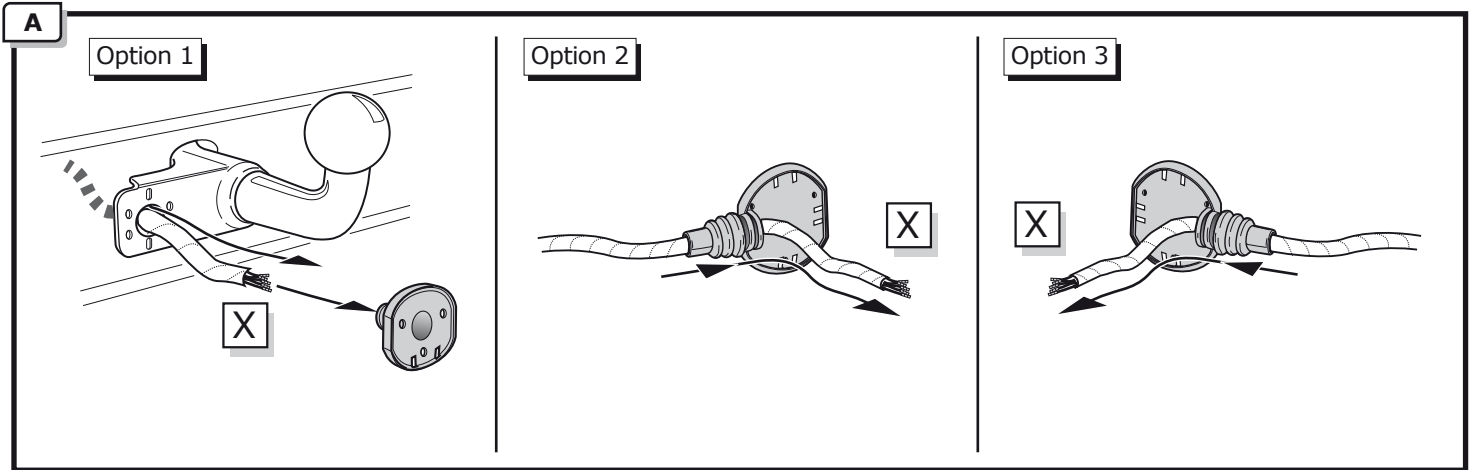

INFO POWER SCHEDULE BW-008-B1U

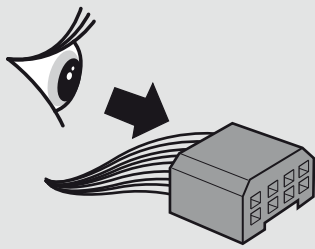

L	←	54	STOP
R	→	54G	⚡
58L	⚡	BU	⊕ _r
58R	⚡	Ground/31	⊖

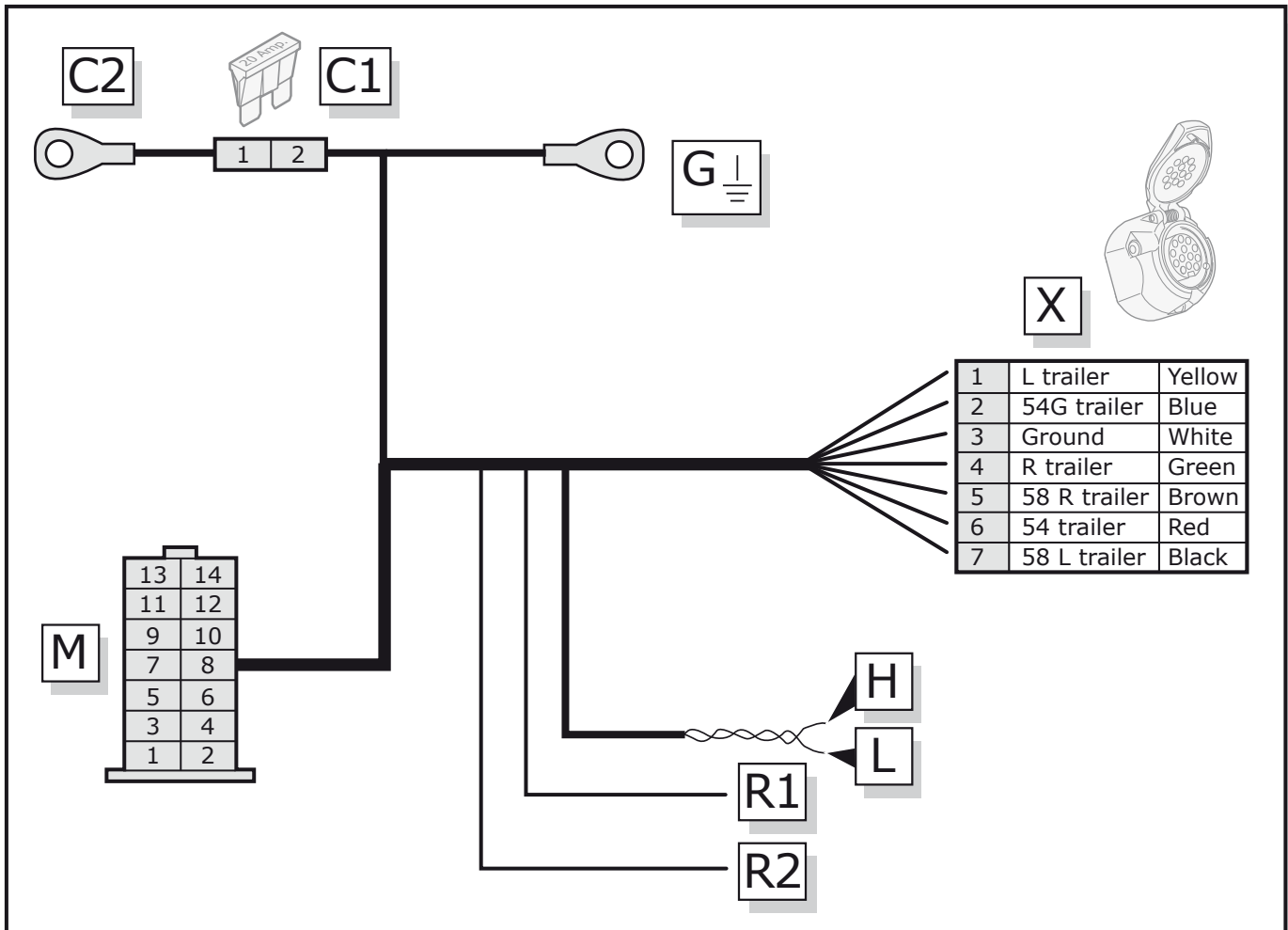

M	1	Red	54 trailer	out
	2	Orange	+30 (12 V)	in
	3	Red/White	R	in
	4	Yellow	L trailer	out
	5	Blue/Red	54	in
	6	Black	58 L trailer	out
	7	Green	CAN L	in
	8	White	Ground	-
	9	Green/Orange	CAN H	in
	10	Green	R trailer	out
	11	Blue	54G trailer	out
	12	Brown	58 R trailer	out
	13	-	-	-
	14	Orange	+30	in

H	Green/Orange	Can H	in
L	Green	Can L	in
R1	Blue/Red	54	in
R2	RD/WH	R	in
G	WH	Ground	-

C1	1	Red	+30 (12 V)	in
	2	Orange	+30 (12 V)	out

UN-243-YZ Reverse lamp pre-wire extension

⚠ MAX = 21W

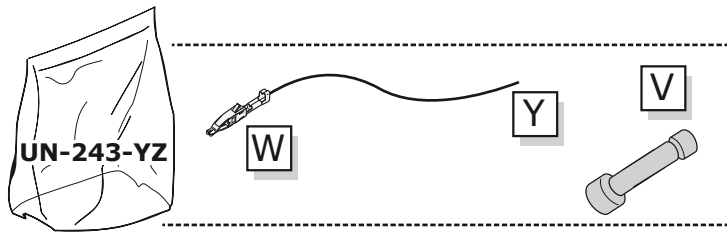

A

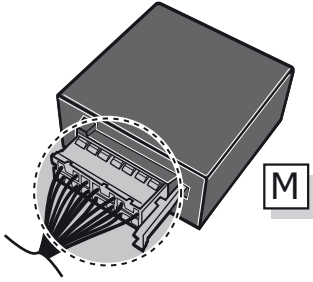

1

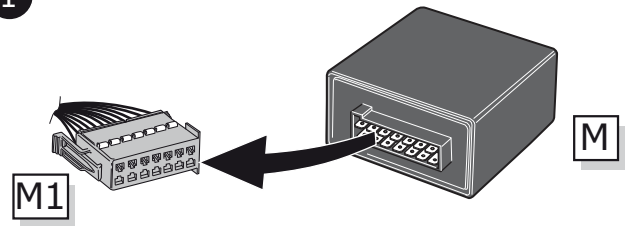

2

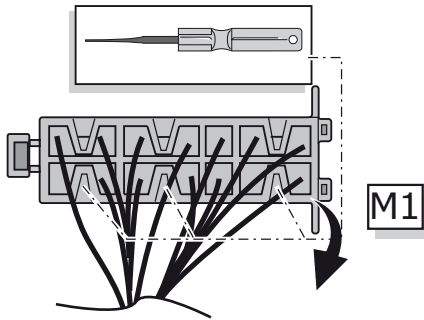

3

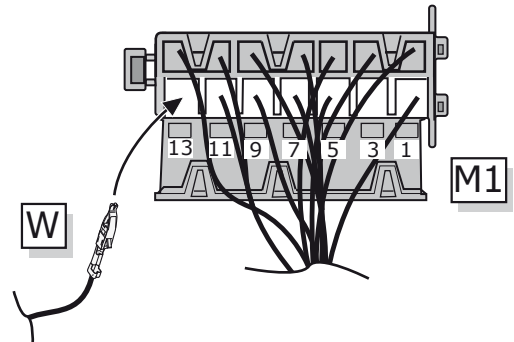

4

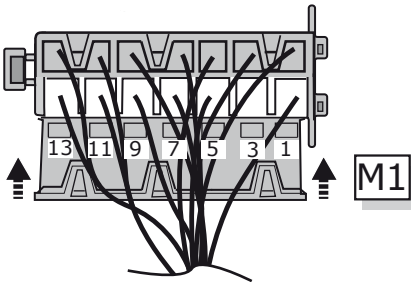

5

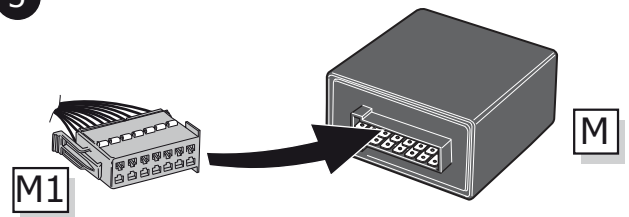

B

⚠ MAX = 21W

