

Citroën C5 10/2008- (Production Nr. 11679-)

Partnr.: CT-046-D1U

- Fitting instructions electric wiring kit tow bar with 13-P socket up to DIN/ISO Norm 11446.
- We would expressly point out that assembly not carried out properly by a competent installer will result in cancellation of any right to damage compensation, in particular those arising by virtue of the product liability act.
- Contents of these kits and their fitting manuals are subject to alteration without notice, please ensure that these instructions are read and fully understood before commencing installation.
- Do not overload circuits; the maximum loads per connection are detailed in this manual.
- Attention! Before Installation, please read this manual carefully and inform your customer to consult the vehicle owners manual to check for any vehicle modifications required before towing.
- In the event of functional problems, troubleshooting must be limited to about 0.5 hours, contact the technical support:
ukts@ecs-electronics.com / 07440 202 052.



Part list

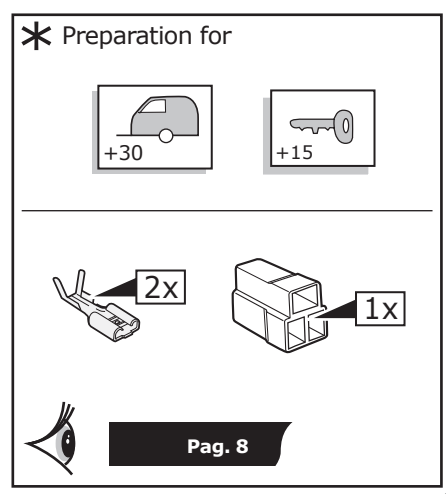
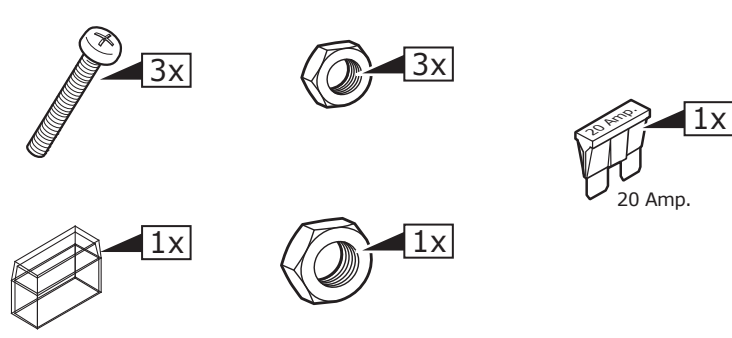
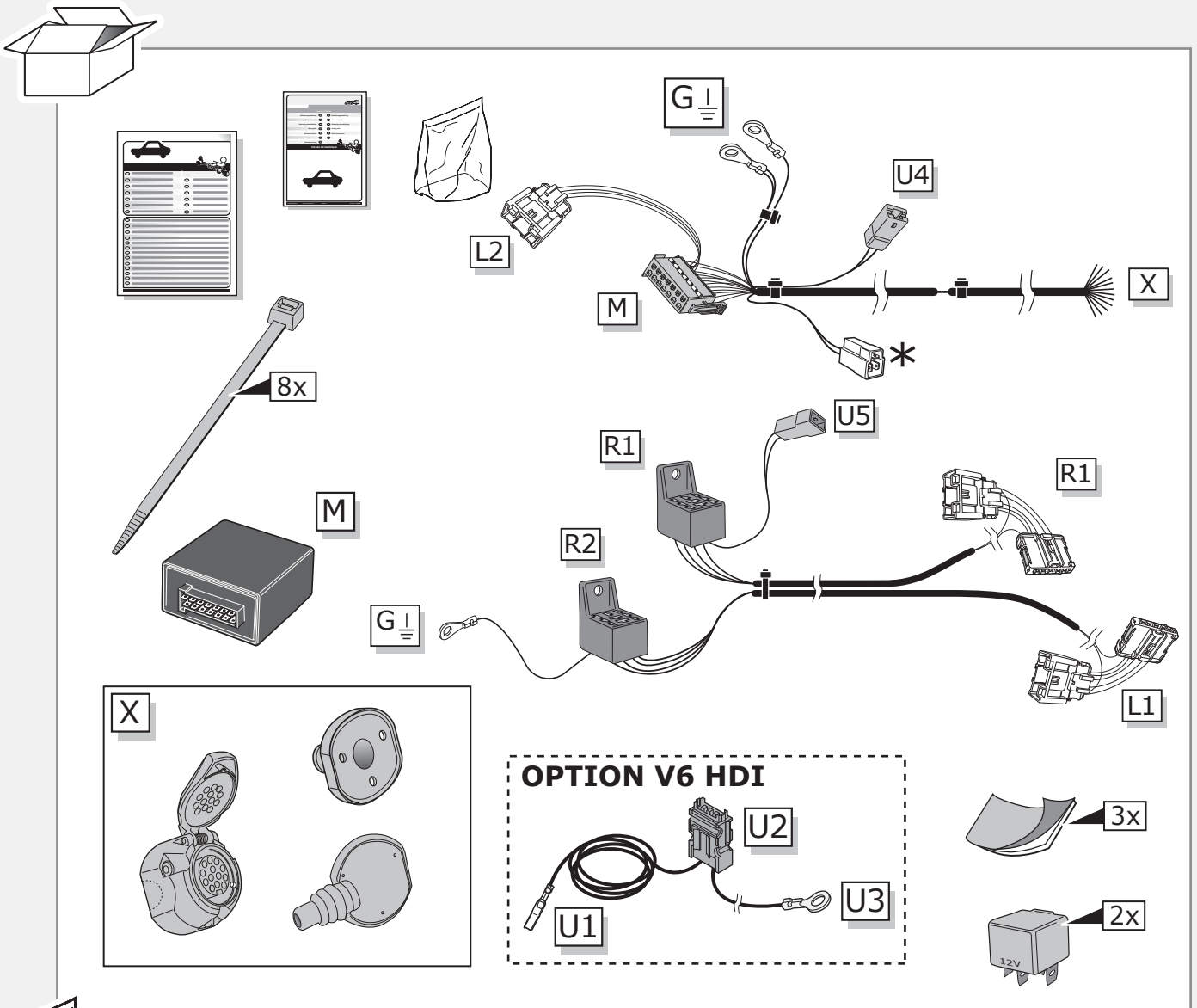

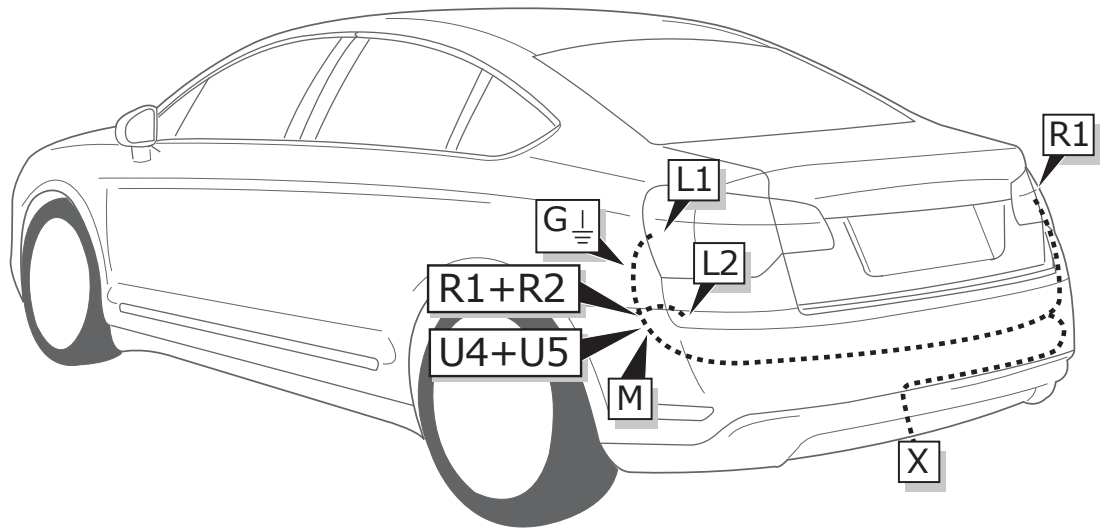

1

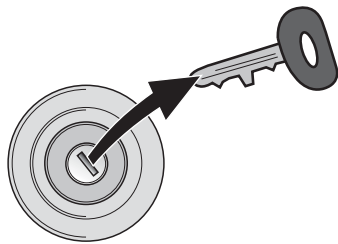

1

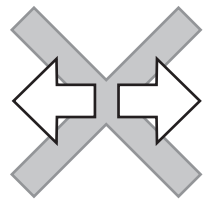
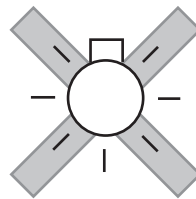

2

2

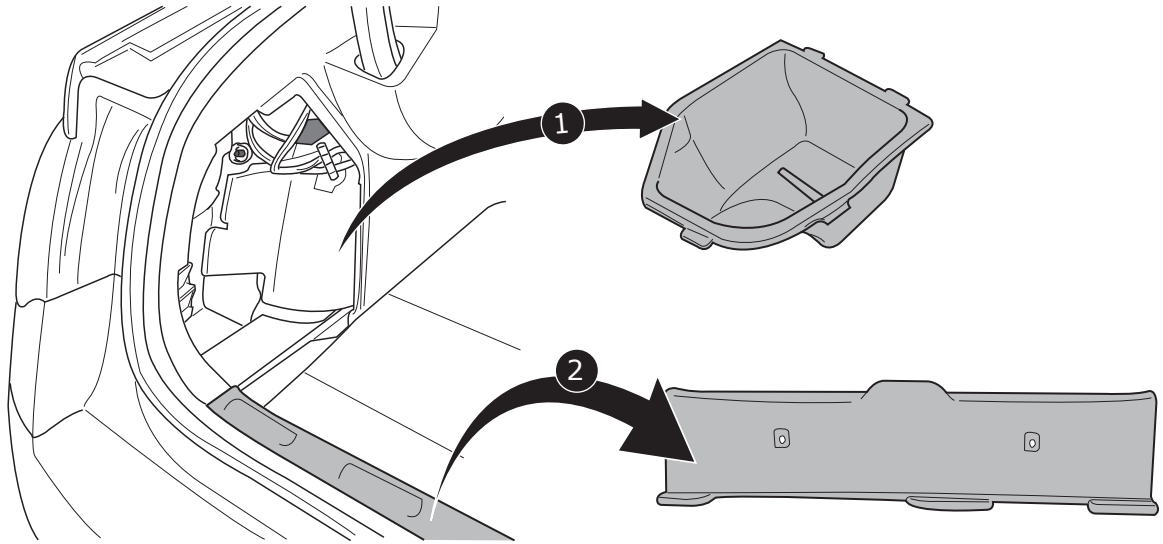

3

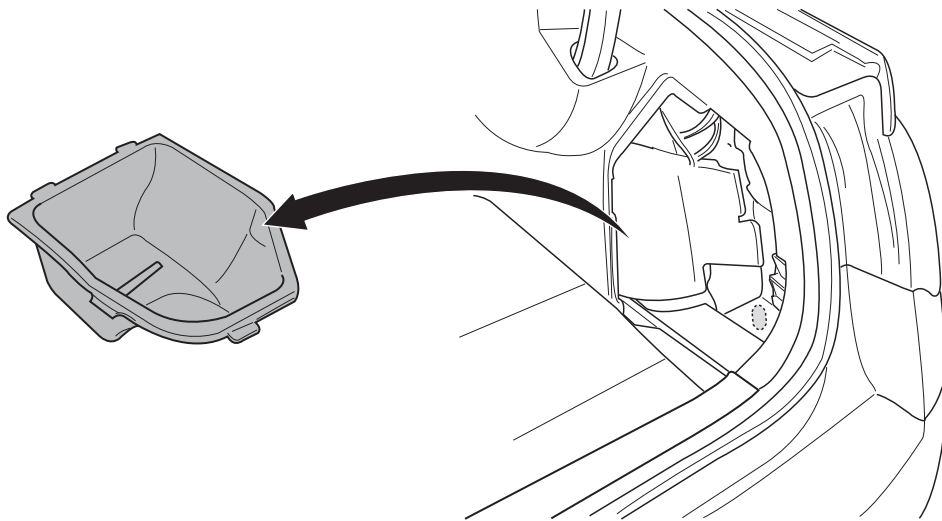

4

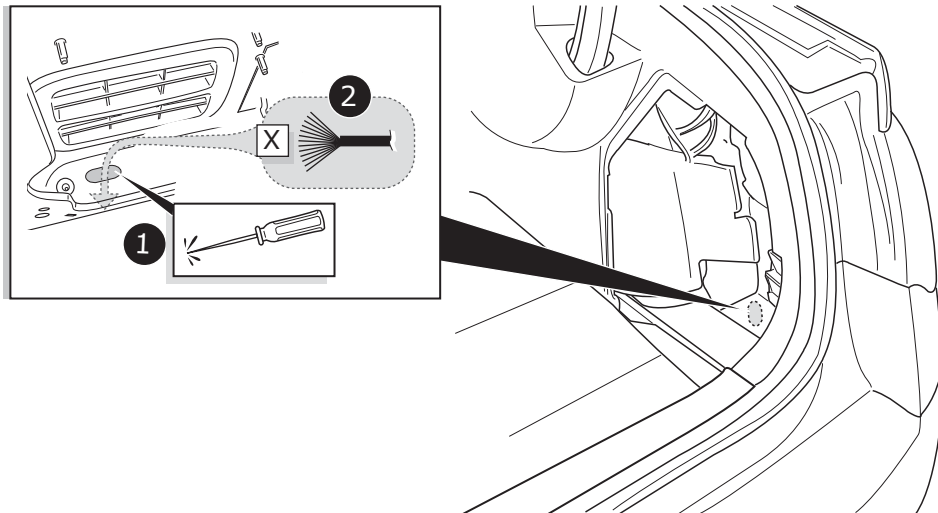

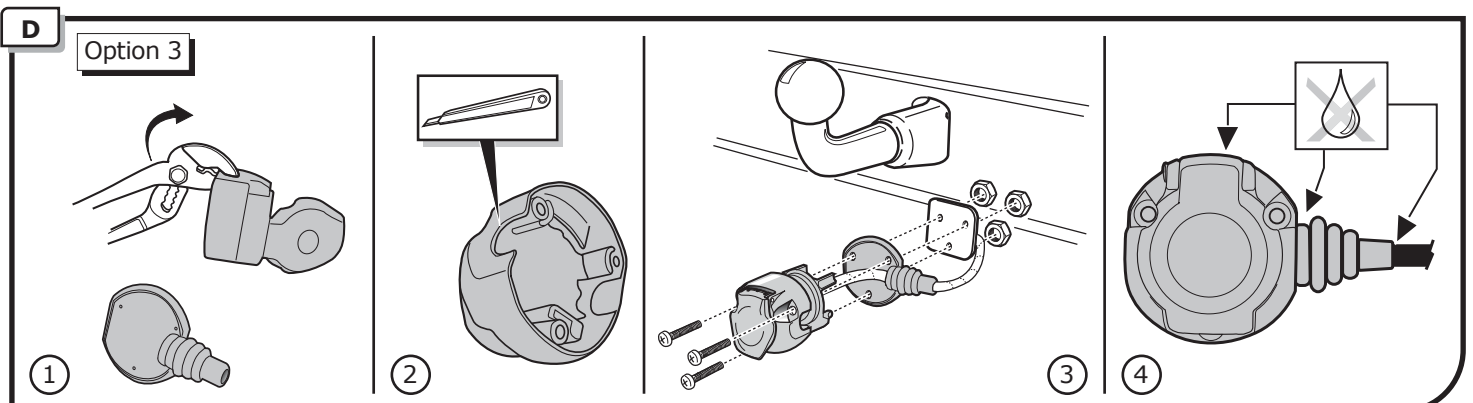
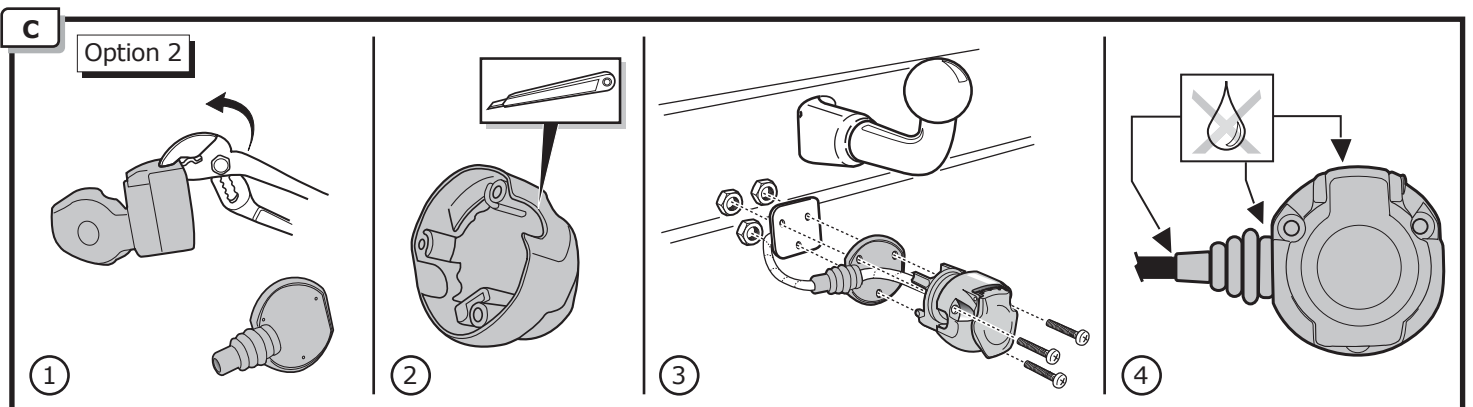
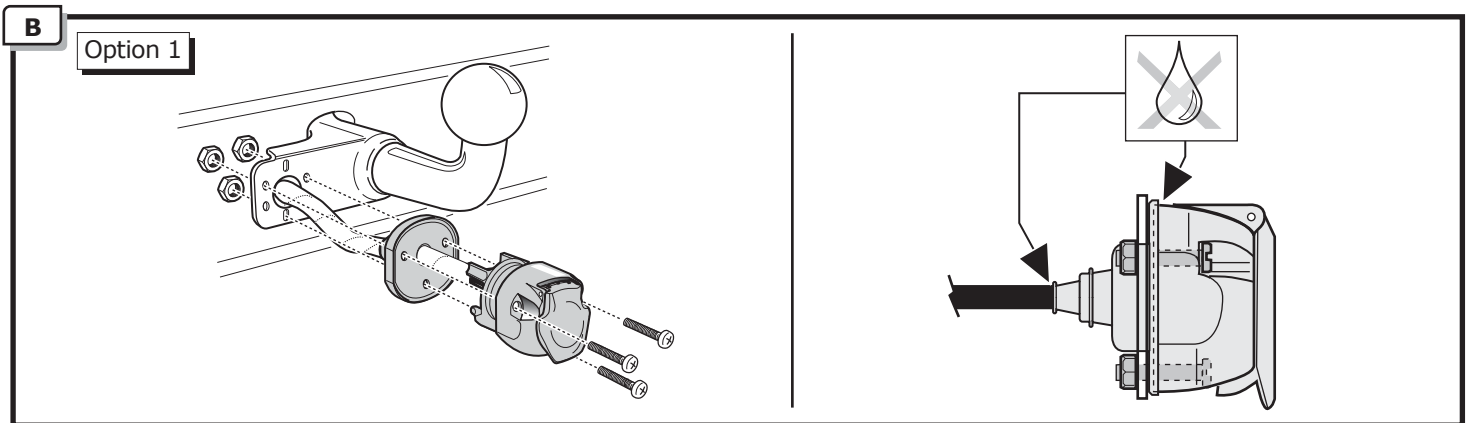
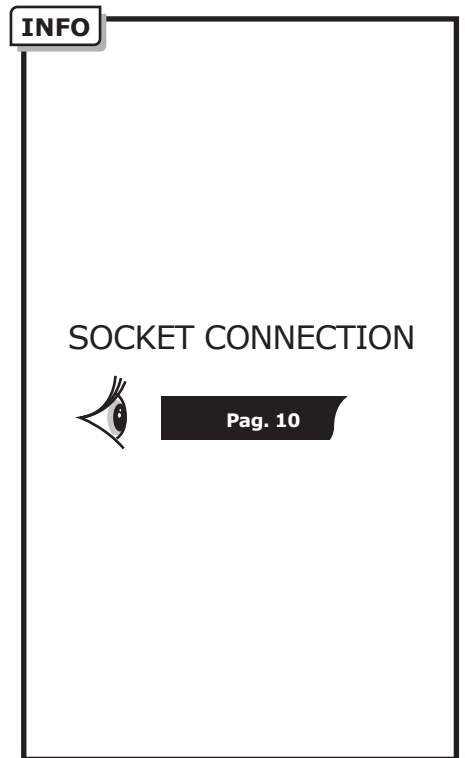
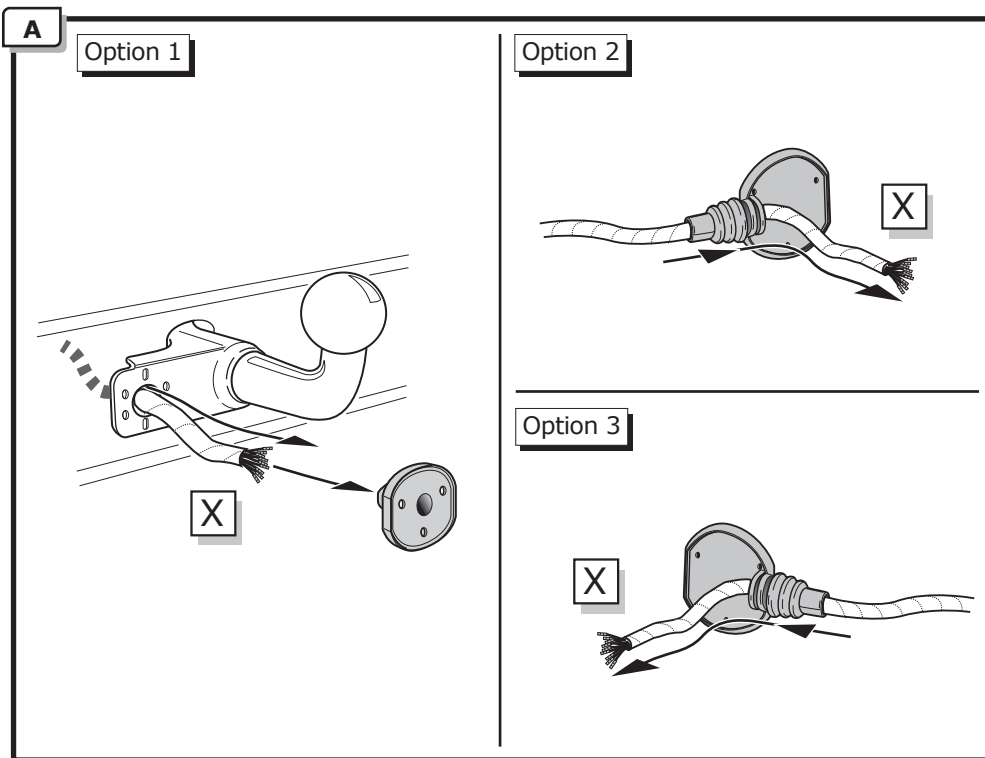

5

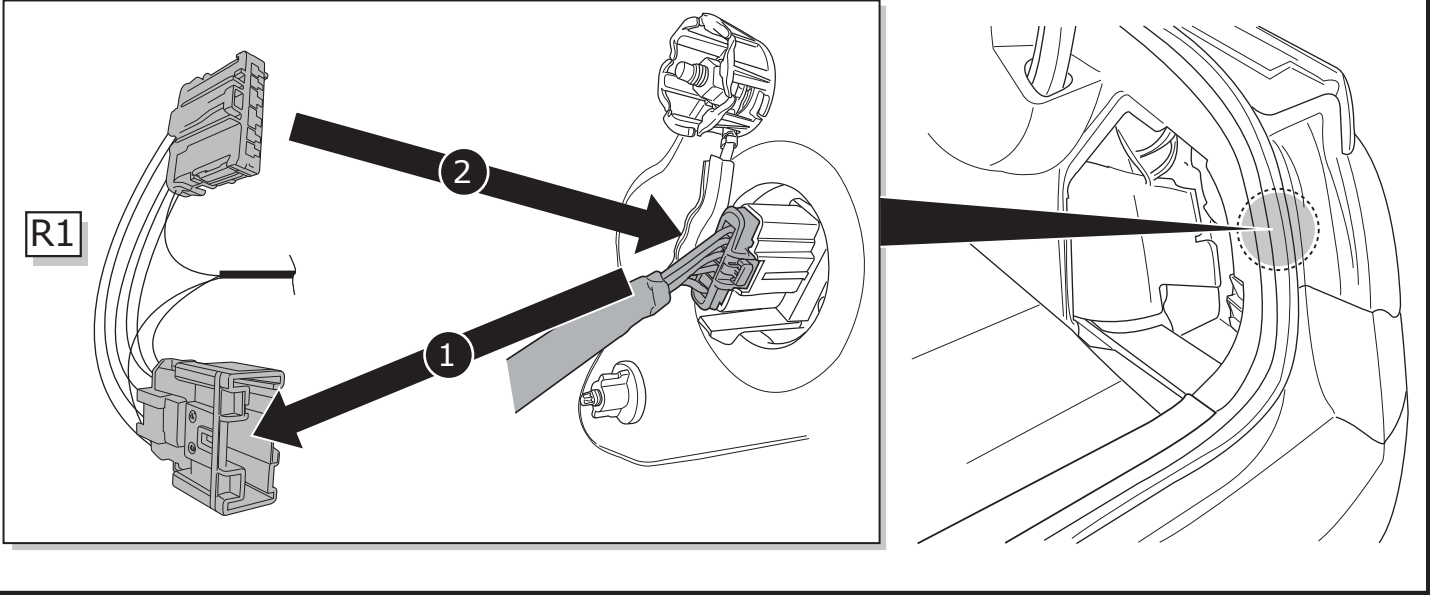

6

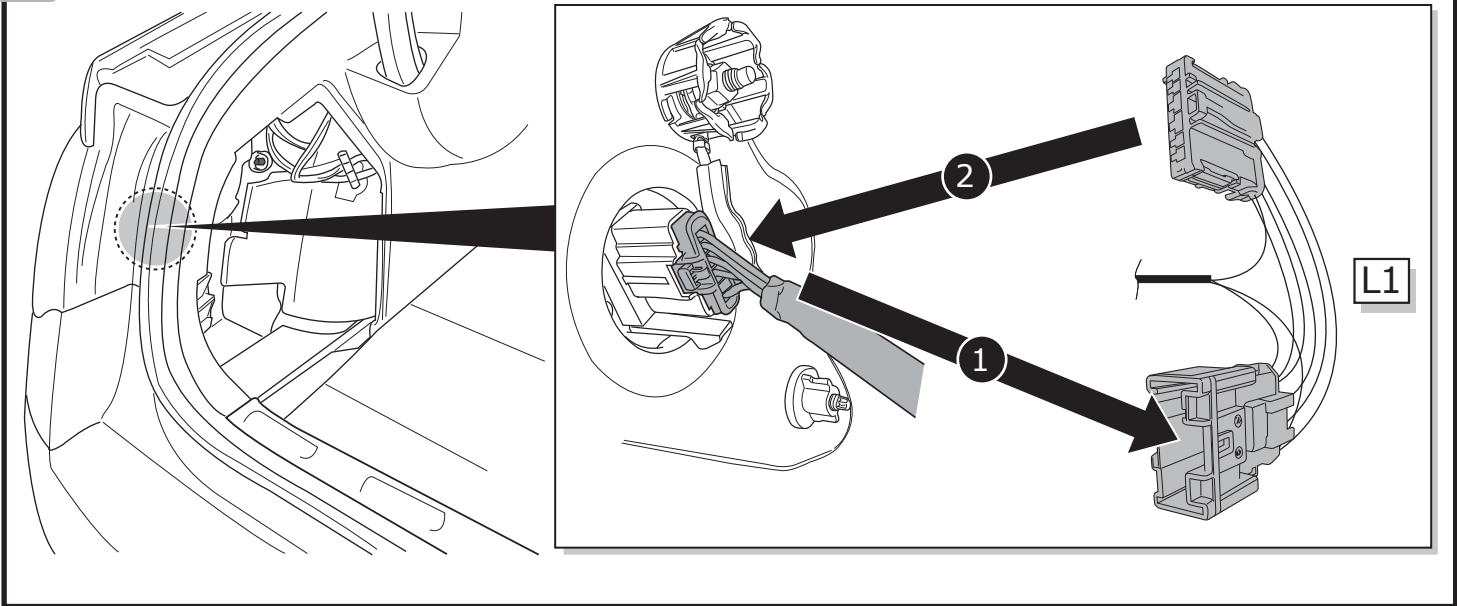

OPTION

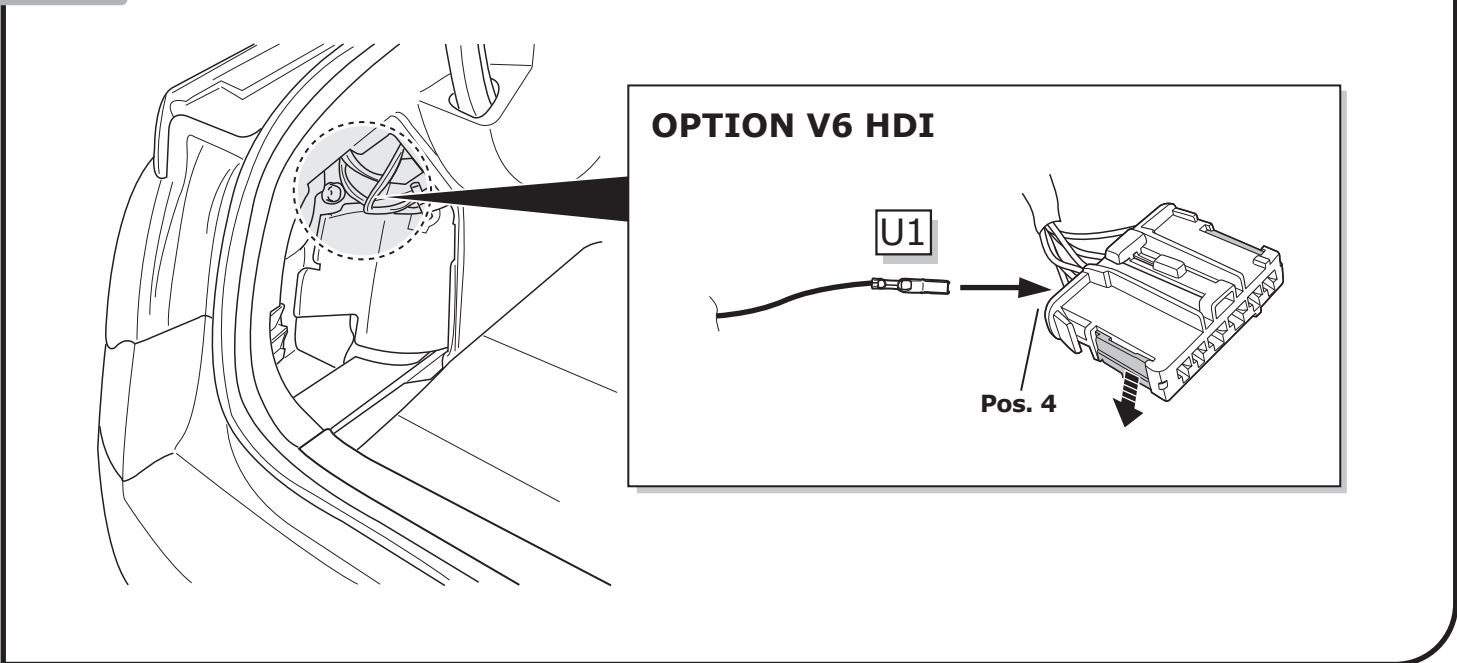

OPTION V6 HDI

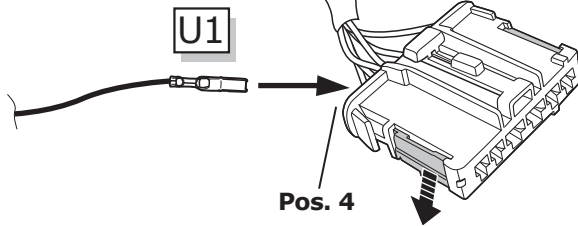

7

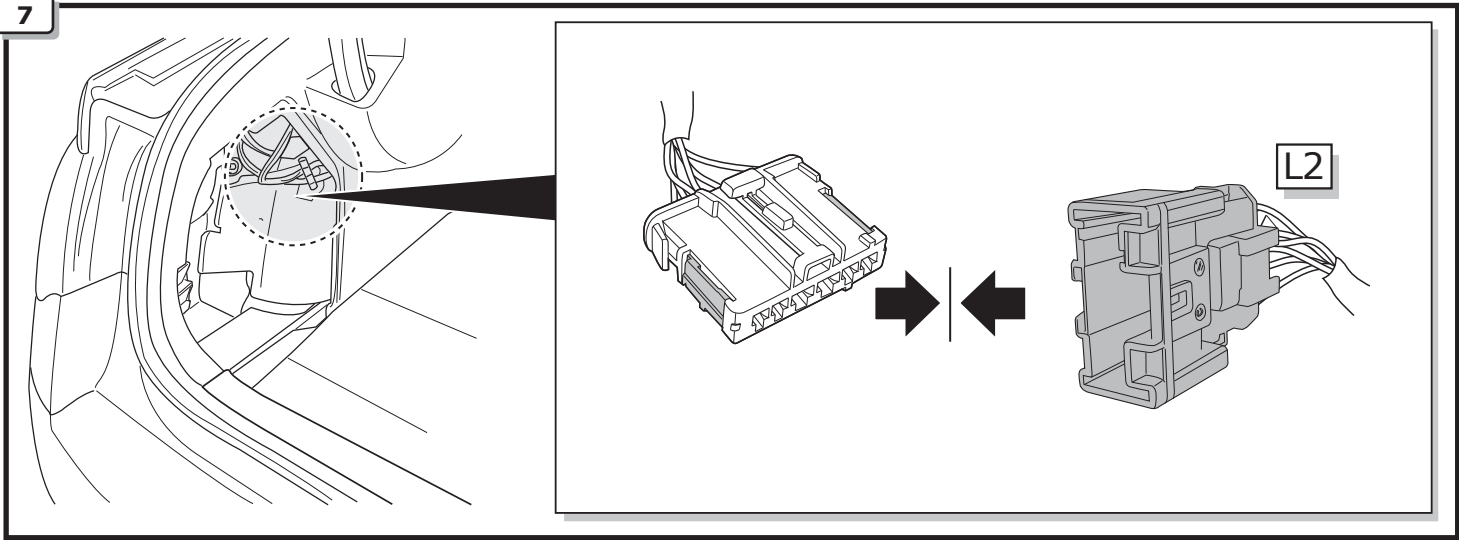

8

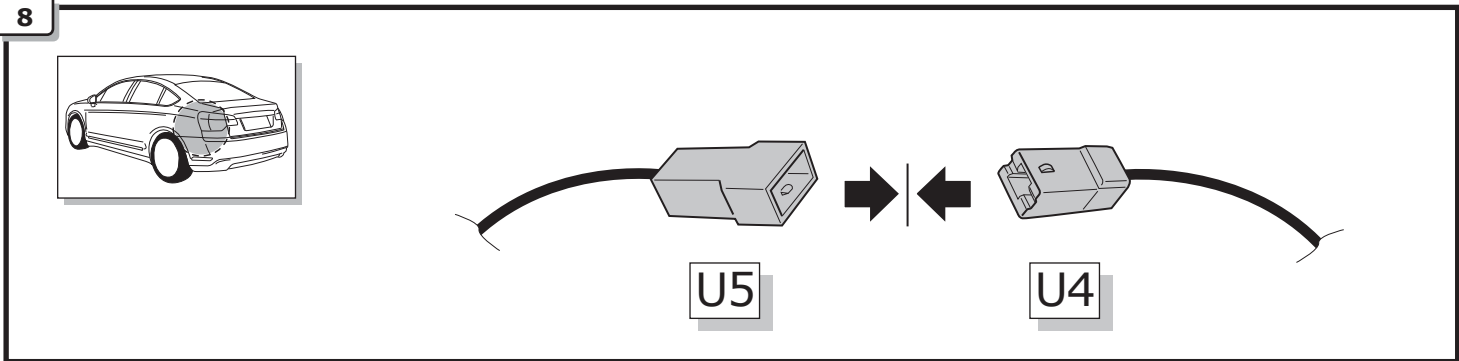

9

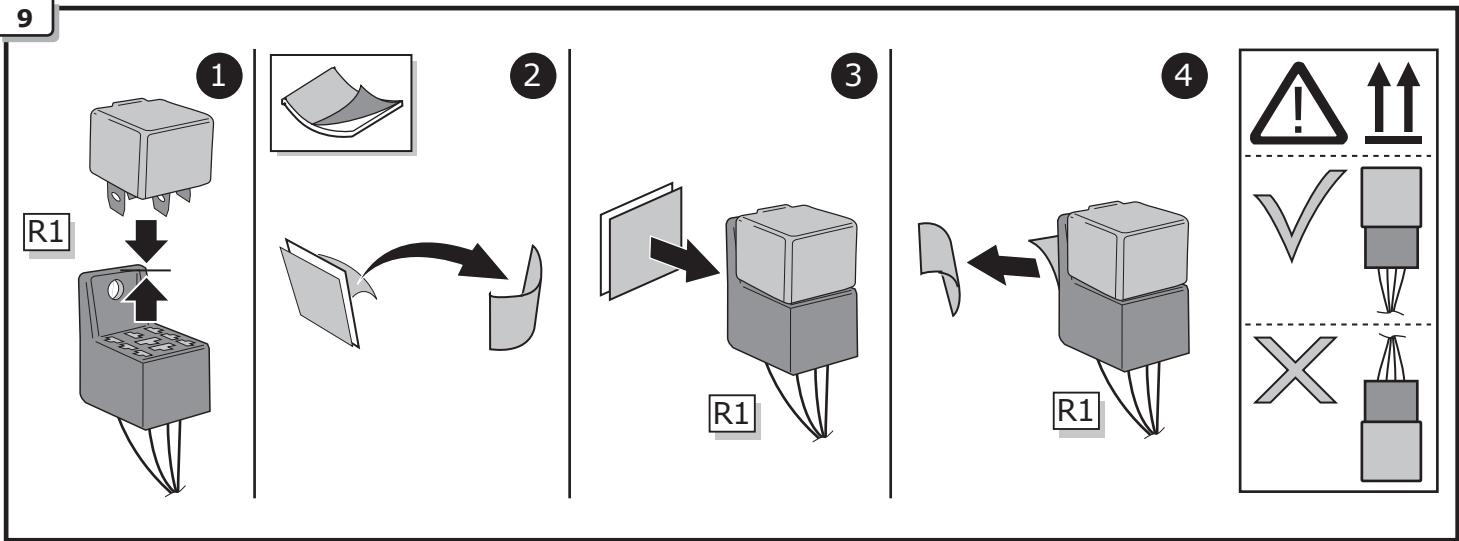

10

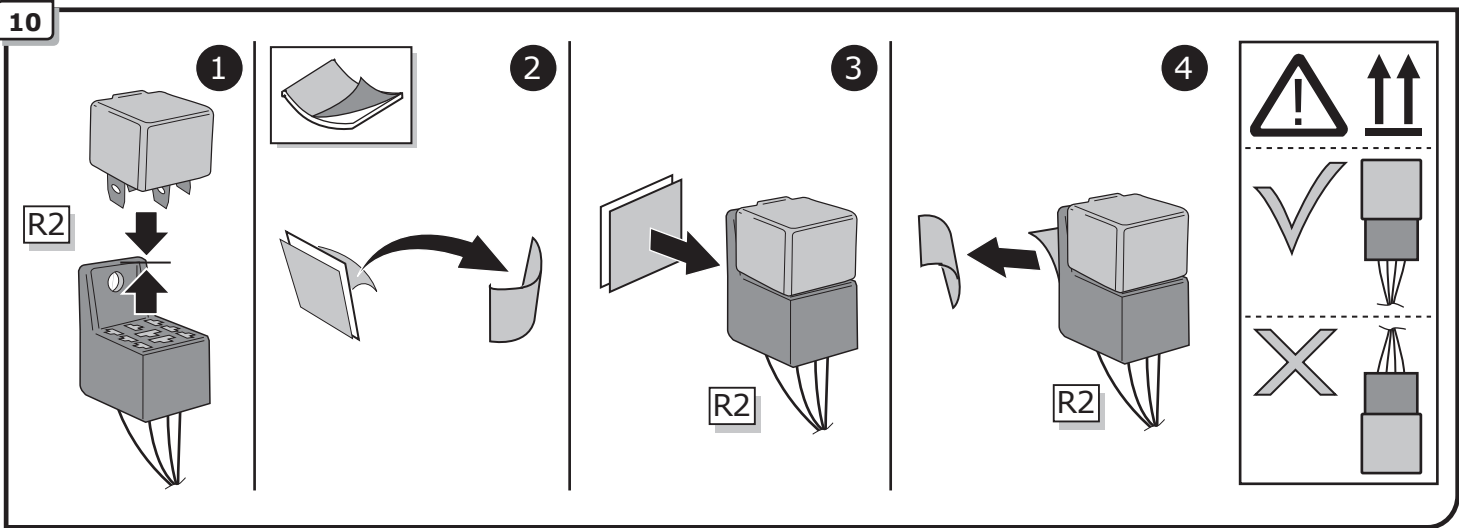

11

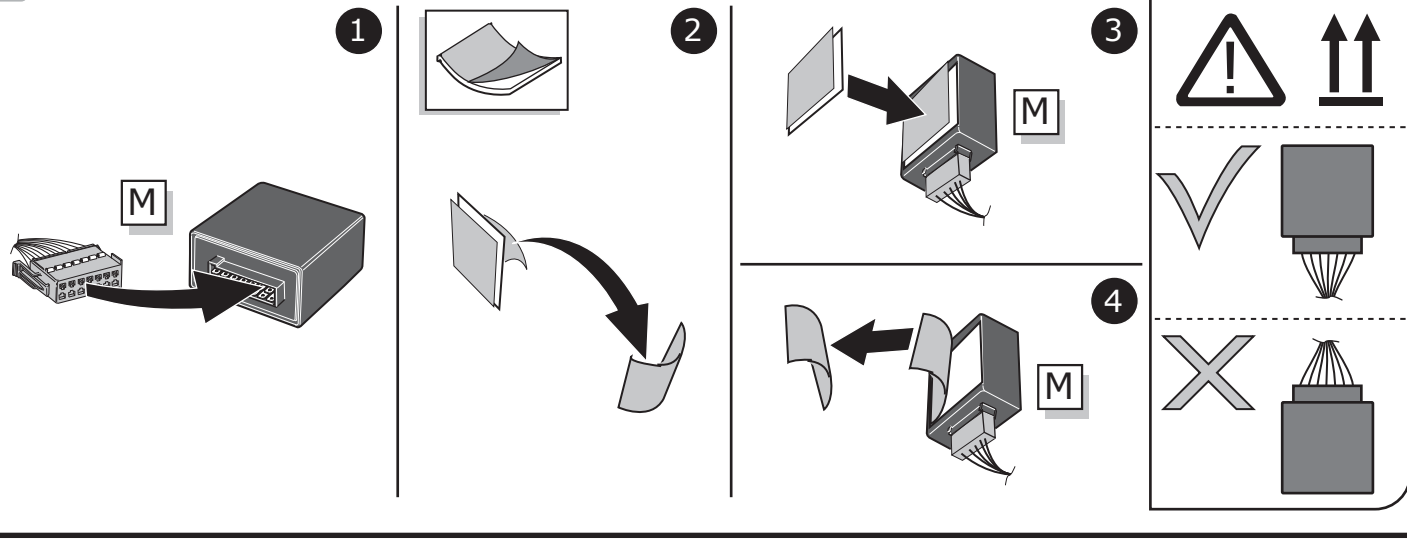

12

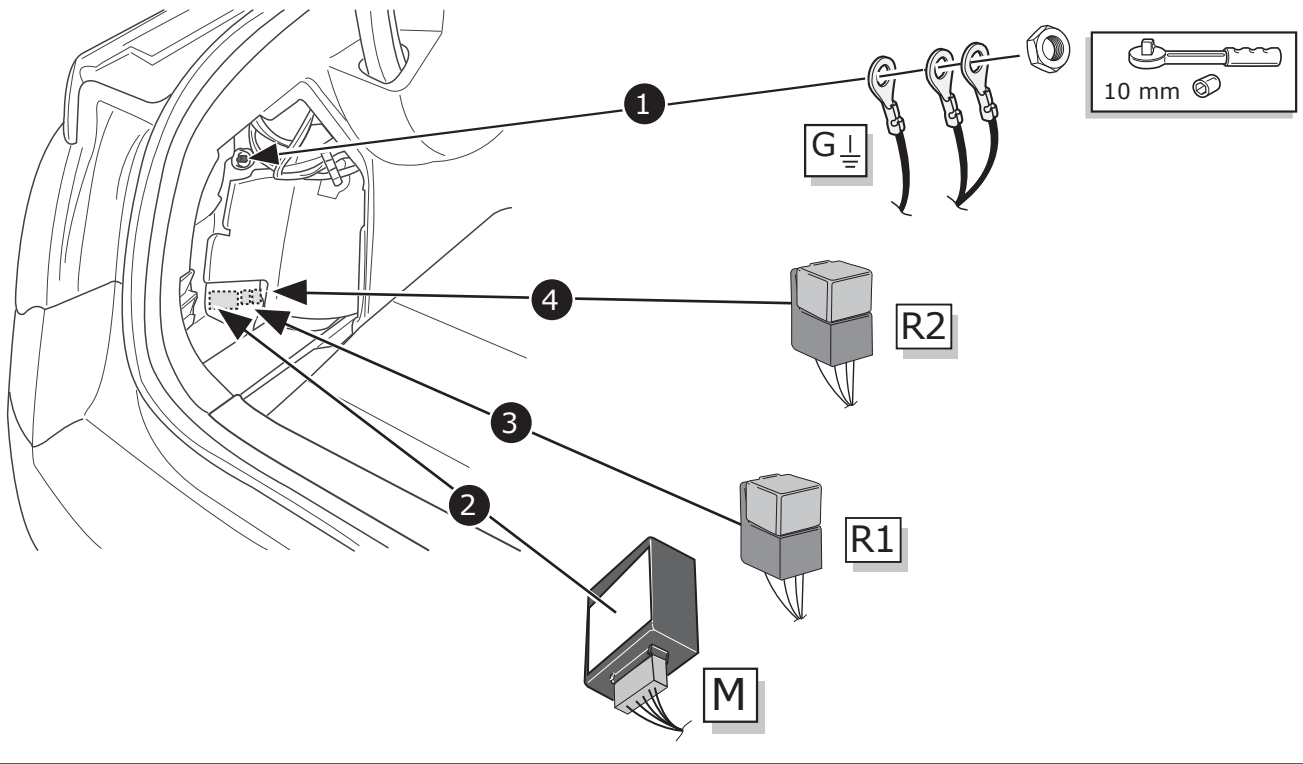

INFO

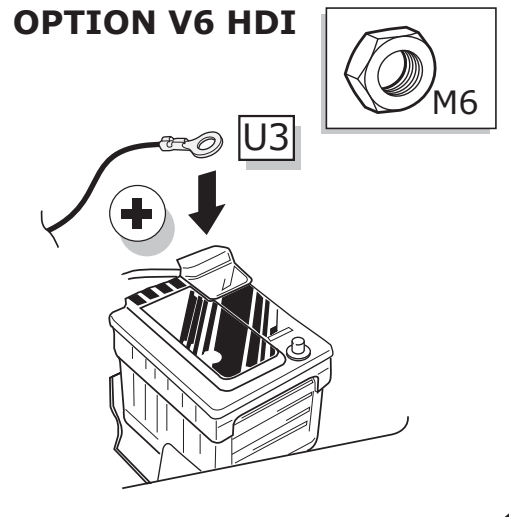
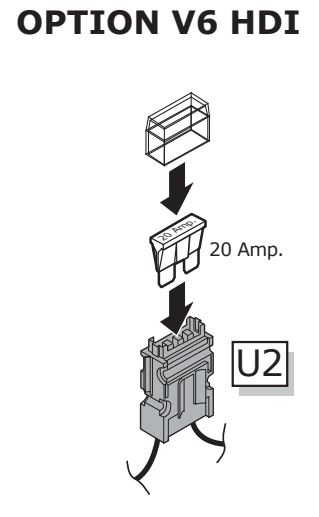
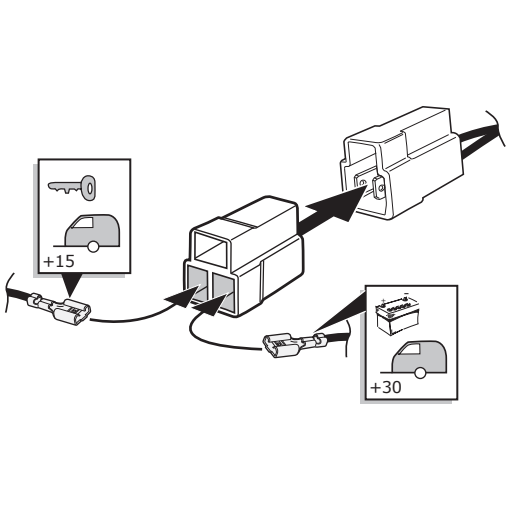

! TEST ALL THE CIRCUITS WITH A TEST DEVICE WITH THE CORRECT POWER LOAD FOR EACH FUNCTION. A TEST DEVICE WITH LED'S CANNOT BE USED FOR THIS PURPOSE.

INFO

REINSTALL TRIM.

INFO

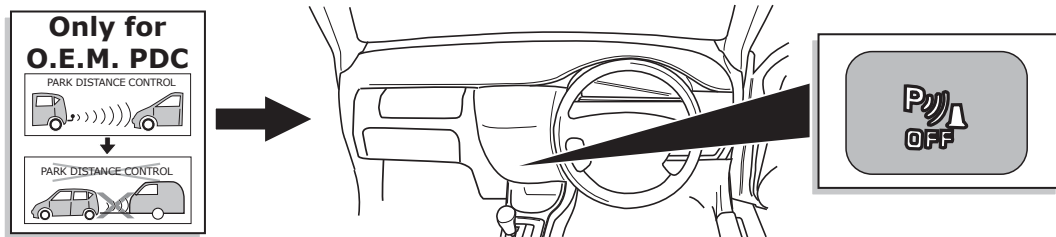

INFO

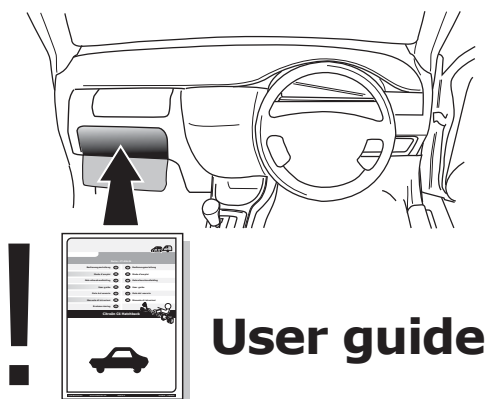
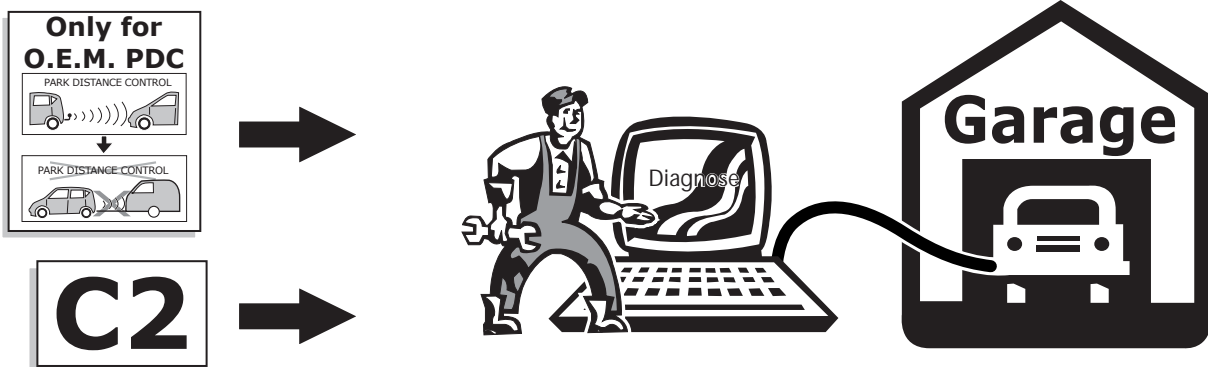













TECHNICAL SUPPORT

CALL 07440 202 052

ECS ELECTRONICS MONDAY TO FRIDAY
08.00 - 11.00 am
12.00 - 05.00 pm
ukts@ecs-electronics.com
www.ecs-electronicsuk.co.uk

SOCKET CONNECTION

DIN/ISO 11446													
	1/L	2	3/31	4/R	5/58-R	6/54	7/58-L	8	9	10	11	12	13
Pmax	21W	2x21W		21W	52W	3x21W	52W	2x21W	180W/15Amp	180W/15Amp			
Colour	Yellow	Blue	White	Green	Brown	Red 1,00 mm ²	Black	Black/ Red	Brown/ White	Red 2,50 mm ²	White	-	White