

! INFO !

Do not charge the battery of the towing vehicle and/or towed vehicle directly via the socket.

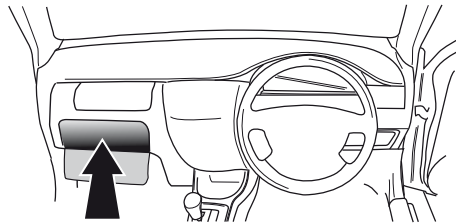

User guide

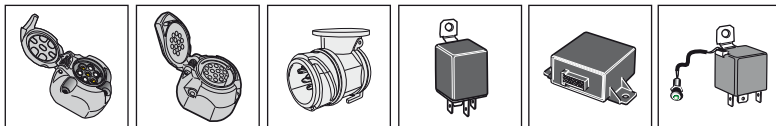

SPARE PARTS

www.ecs-electronicsuk.co.uk



Partnr.: FR-074-H1U

User Guide

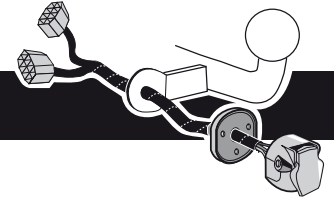

- Ford Mondeo / Hybrid 11/2014 >>**
- Ford S-Max 09/2015 >>**
- Ford Galaxy 09/2015 >>**

For models with trailer preparation

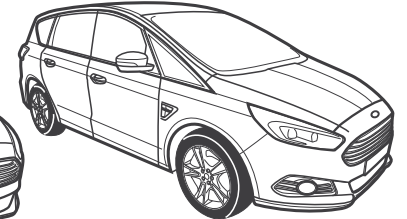
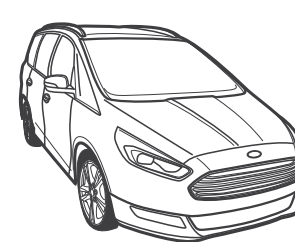
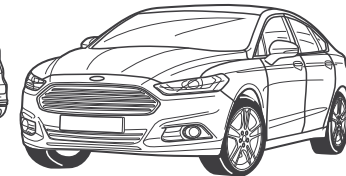

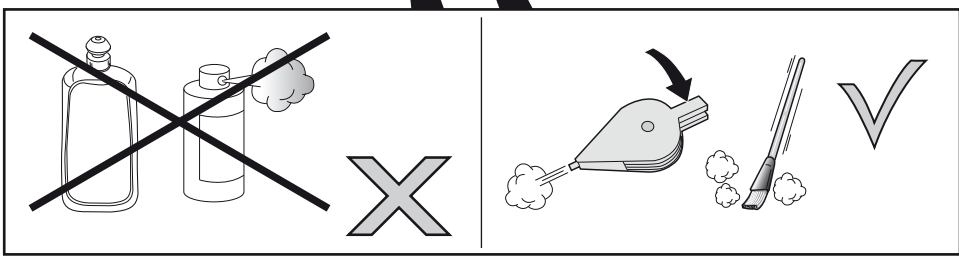
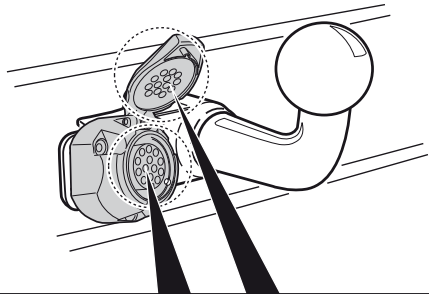
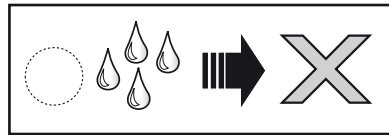
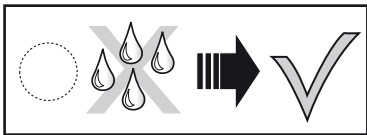
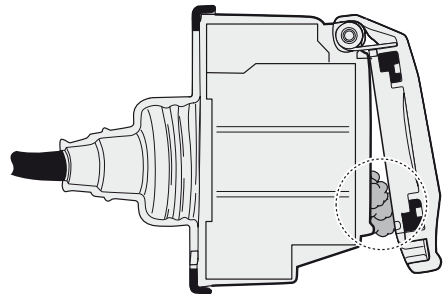
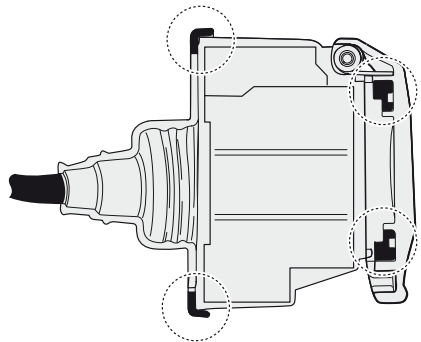
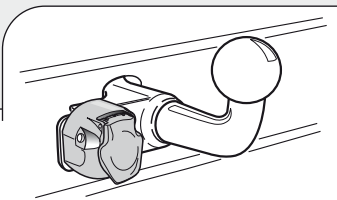
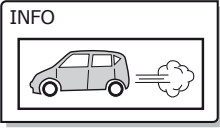

CHANGING THE FUSE

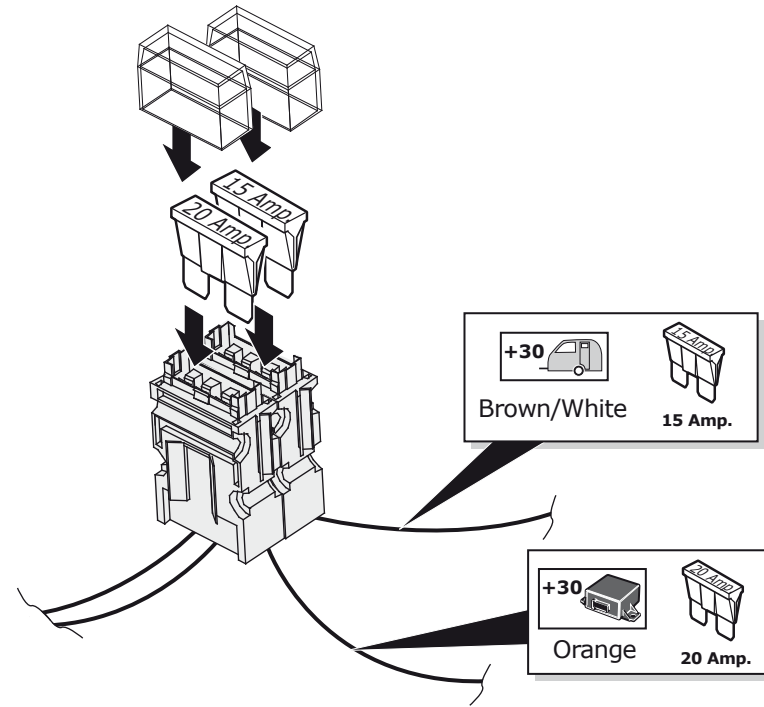
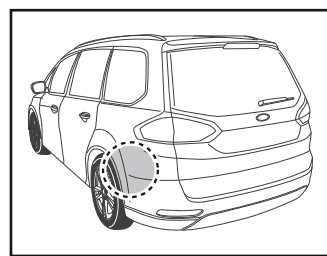
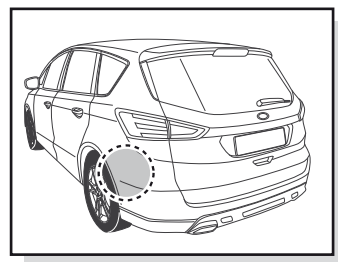
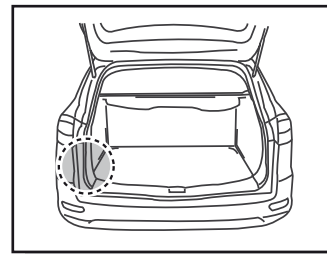

SOCKET CONNECTION

DIVISO 11446			1-8								10	11	12	13
	1/L	2	3/31	4/R	5/58-R	6/54	7/58-L	8	9	10	11	12	13	
Pmax	21W	21W		21W	42W	3x21W	42W	21W	180W/15Amp	180W/15Amp				
Colour	Yellow	Blue	White	Green	Brown	Red 1,00 mm ²	Black	Black/ Red	Brown/ White	Red 2,50 mm ²	White	-	White	

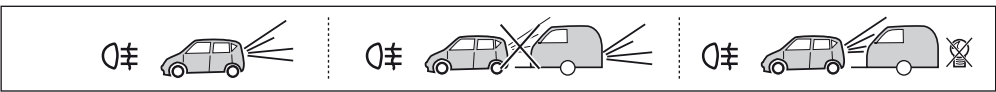

In a coupled trailer with working fog lamp, the fog lamp of the vehicle will be switched off, if applicable.

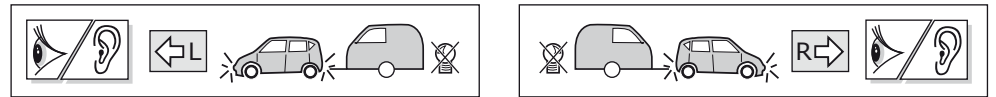

The flashing lights on the trailer are monitored. If one of the indicators of the trailer breaks down, a buzzer will be audible and/or a visual signal will be visible on the dashboard. Check the flashing lights on the trailer.

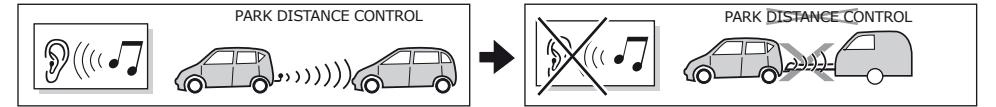

The wiring kit has a possibility to switch off any Park Distance Control in the case of a coupled trailer.

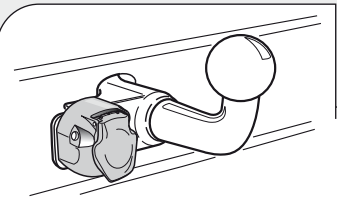

INFO : Ring.

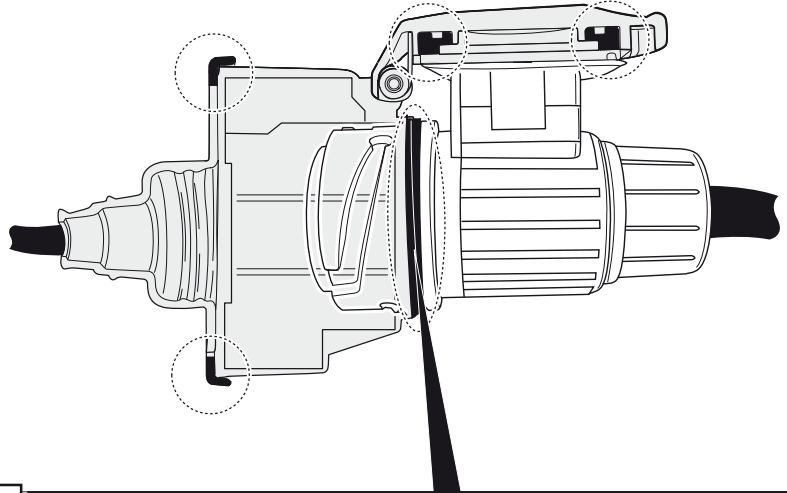
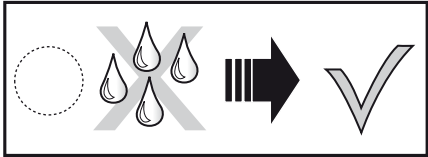

INFO

INFO : Adapt.

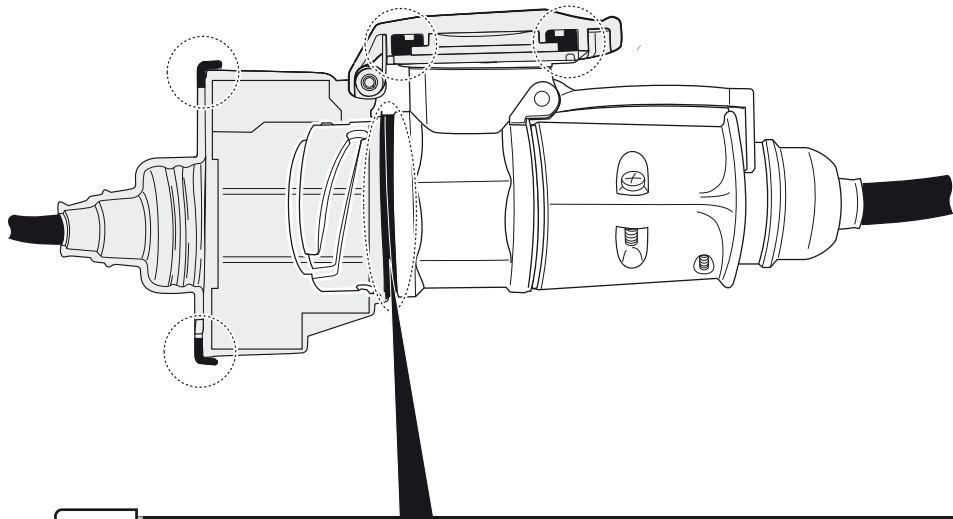
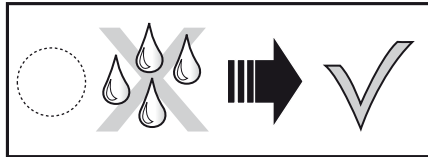
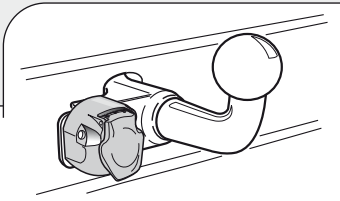
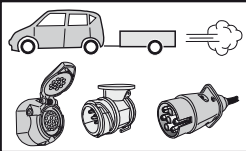

INFO

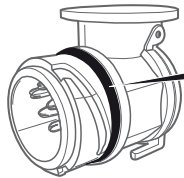
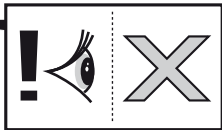
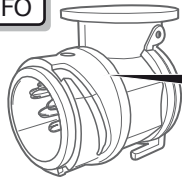

INFO : Storage

