

Cherokee KL 05/2014 >>

Part No: JE-002-07U

Electric wiring kit for towbars / 7-pin / 12N / 12 Volt / ISO 1724 Fitting instructions

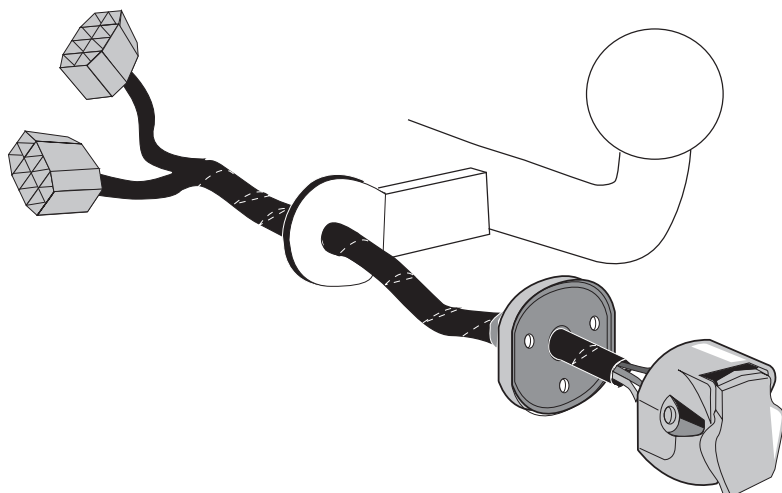

IMPORTANT!

This electric kit has to be installed by a professional workshop or a suitable qualified person.

The installation instructions must have been read and fully understood before the start of any installation. Please contact your wiring kit provider or the hotline shown in the footer should you need assistance!

Make sure the vehicle is approved/homologated by the manufacturer to tow a trailer!

Also please check that there is a definite compatibility between this vehicle and the electric kit!

Following the installation of the electric kit, the fitting instructions should be kept together with the vehicle service document and vehicle handbook. The fitting instructions contain important information relating to the use and function of the towing kit as well as for any diagnostic or activation process, that might have to be repeated in the future (e.g. after the performance of a vehicle software update).

All warranty claims will be forfeited if the electric kit or components contained therein are used incorrectly or modified. If a towing socket adaptor has been used to connect to the trailer or bike rack, this must be removed from the trailer socket once the trailer or bike rack has been disconnected.

If the trailer or bike rack is not equipped with a rear fog lamp, depending on the towing vehicle type, the correct function of the towing kit cannot be guaranteed. In such cases, a rear fog lamp should be retro fitted.

This towing electric kit will not be covered under warranty if any technical or electrical modifications or software updates have been performed by the vehicle manufacturer after the initial commissioning of the kit. That applies especially to modifications or updates which may cause malfunctions in the trailer socket or any other part of the trailer electrical equipment!

Depending on the type of trailer module used in this electric kit, diagnostic interrogation with the vehicle's electrical system may be limited or will not function. The error memory inside the trailer module may not be able to be accessed by vehicle manufacturers diagnostic system.

Error logs relating to the trailer electrical equipment, that may be generated in the vehicle manufacturers diagnostic system as a result of a test procedure, may be due to the incorrect installation of the towing electric kit or the false activation of the trailer module.

We always recommend whenever possible, the following troubleshooting process:

→ **An analysis of the vehicle's error memory and possibly clearing of all faults before the start of the installation!**

→ **Try disconnecting the trailer module from the towing harness and re-start the fault clearing process!**

→ **If in doubt, limit the time for troubleshooting to a max of 0,5 hours and call our Technical Support Team!**

Please follow our instructions carefully and always test the towing electrics using a true lighting board or a specifically designed bulb tester. If an LED tester is used, ensure it is equipped with correct load resistors or malfunctions will occur!

This instruction is subject to changes and we reserve the right to make changes to design, colour etc.

All of the data and illustrations may not be an exact representation but the text contained in this instruction must be observed!

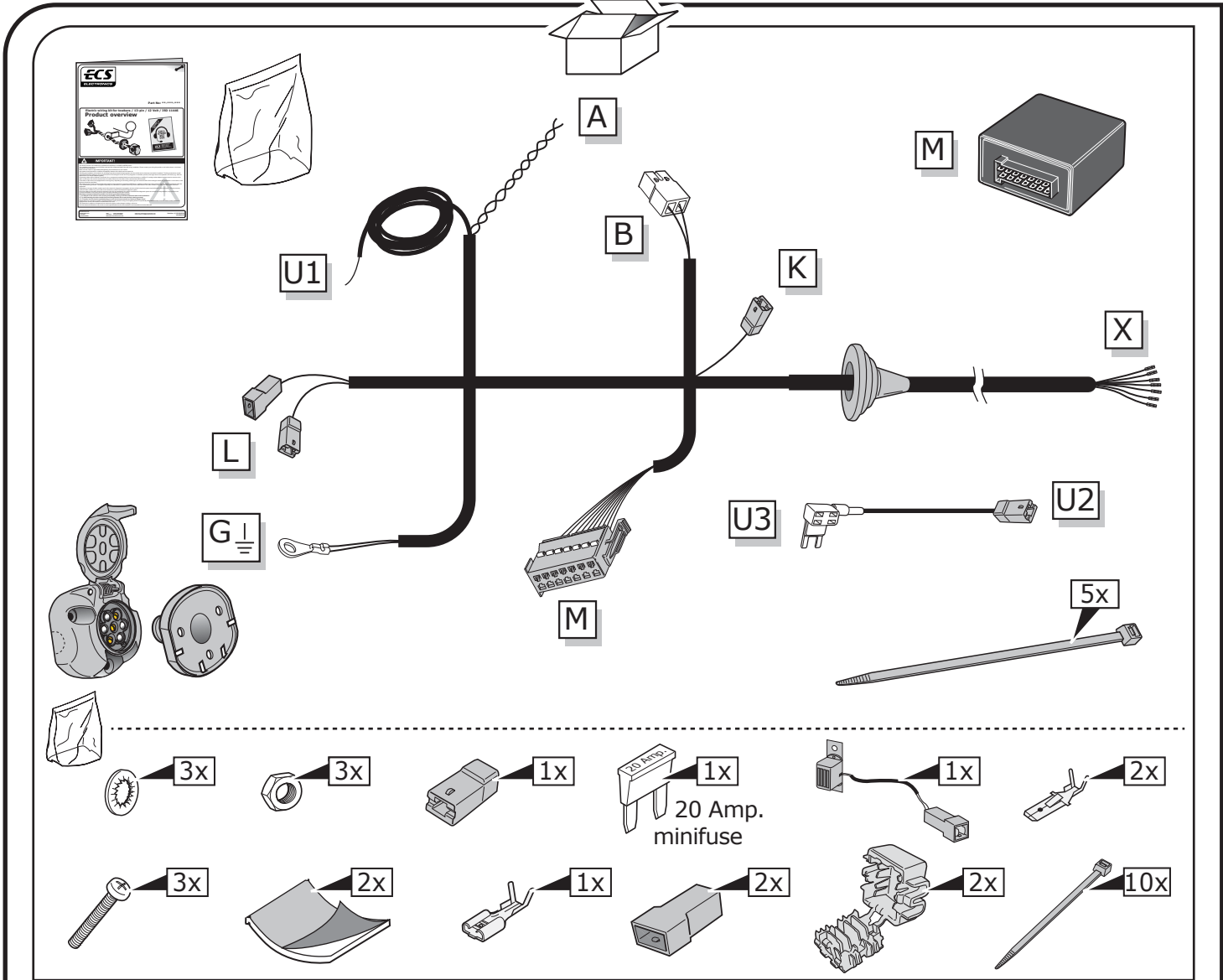

- Parts list for the wiring harness kit:
- 3x Screws
 - 3x Washers
 - 1x Connector
 - 1x 20 Amp. minifuse
 - 1x Power cable
 - 2x Remote control cable
 - 3x Screws
 - 2x Grounding terminal
 - 1x Connector
 - 2x Connector
 - 2x Connector
 - 10x Screws

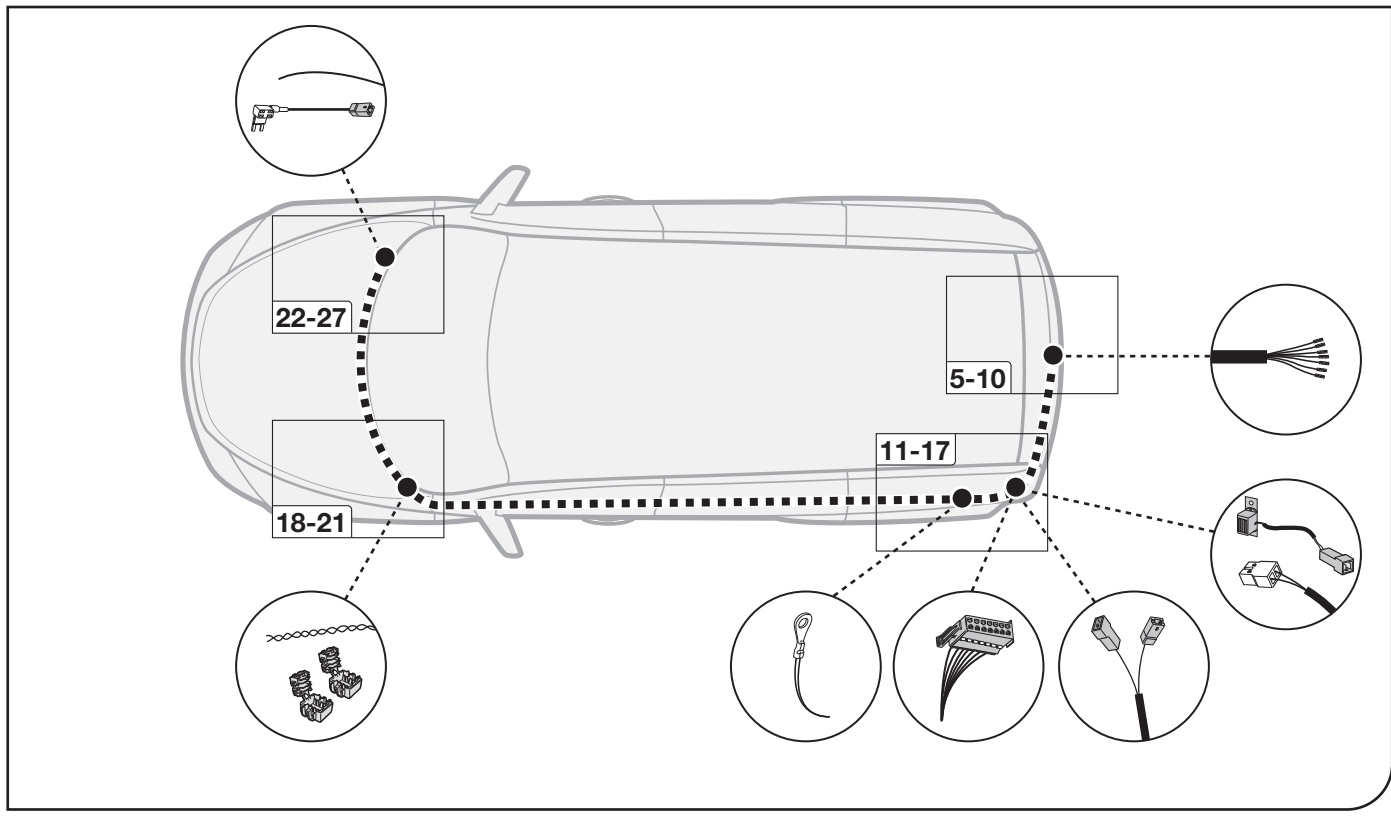

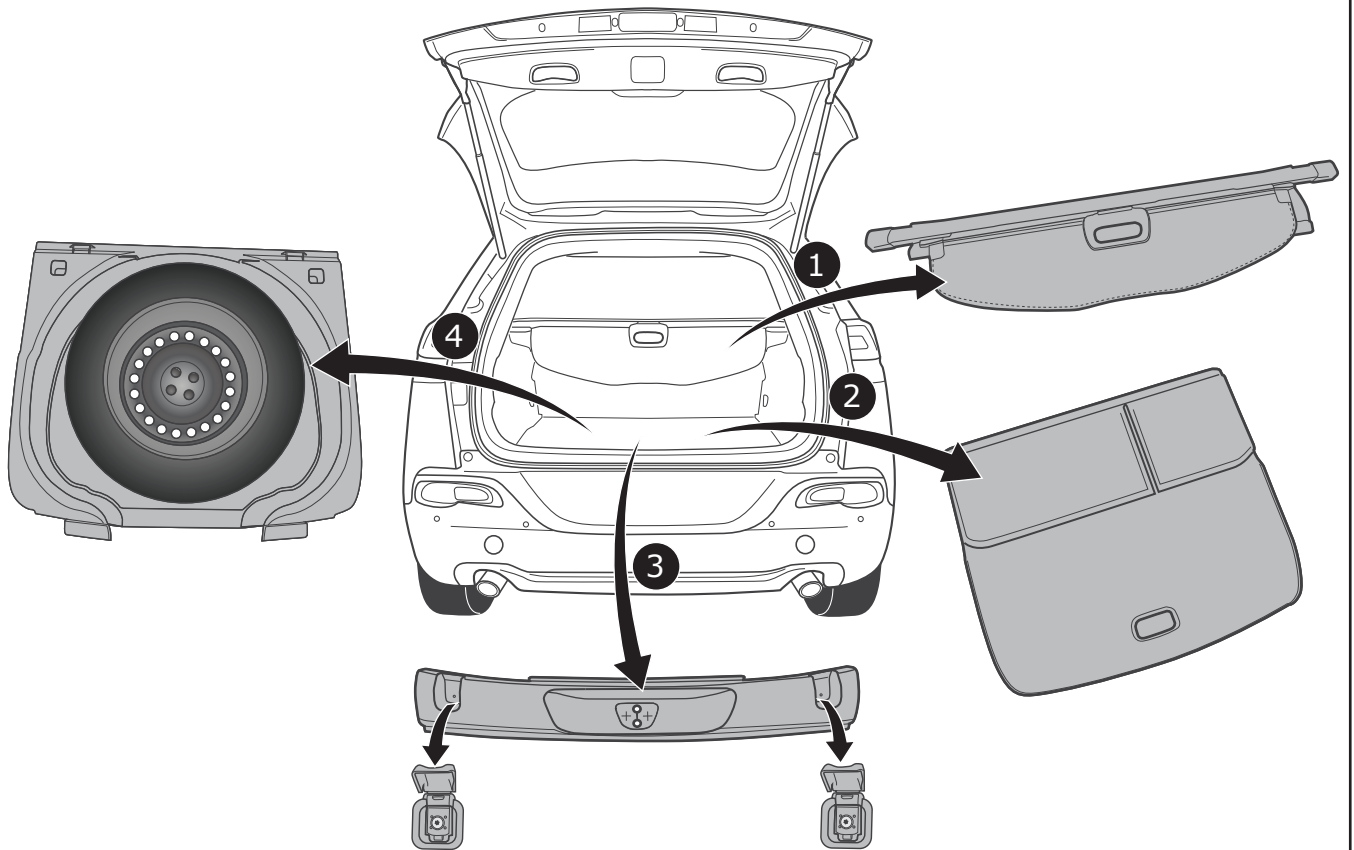

2

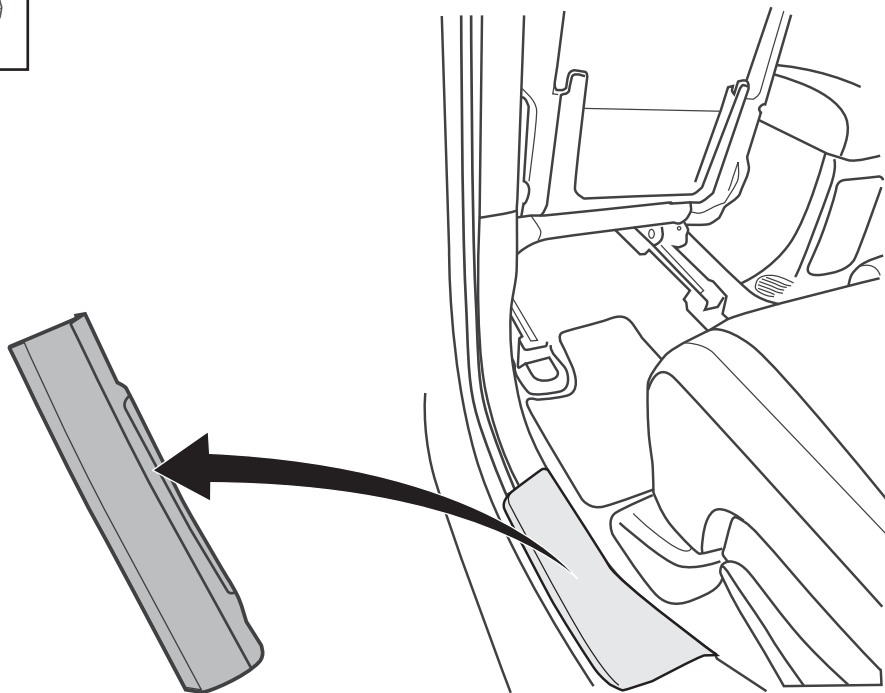

3

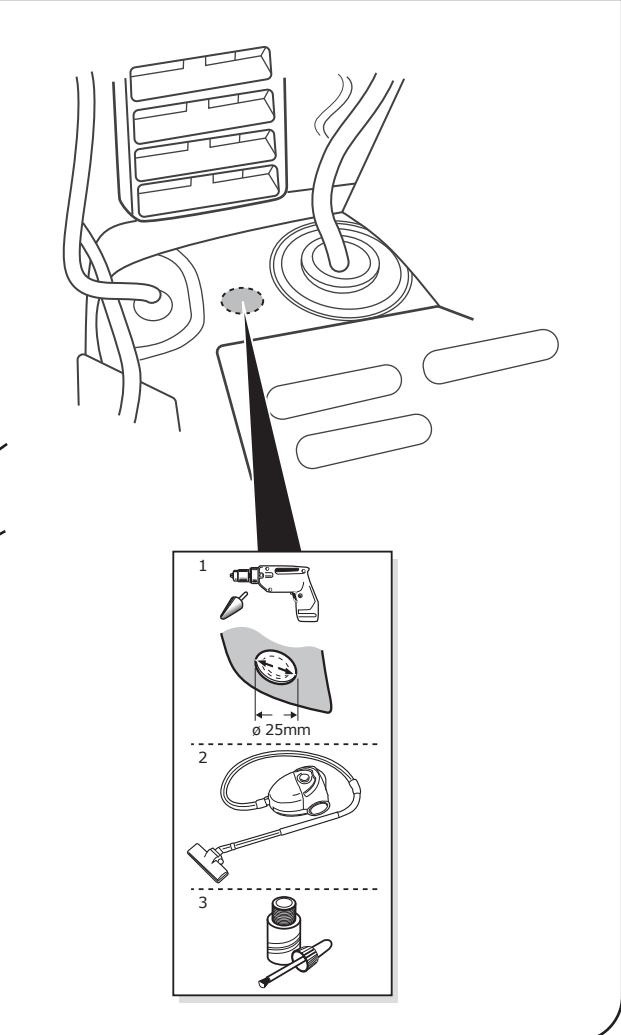
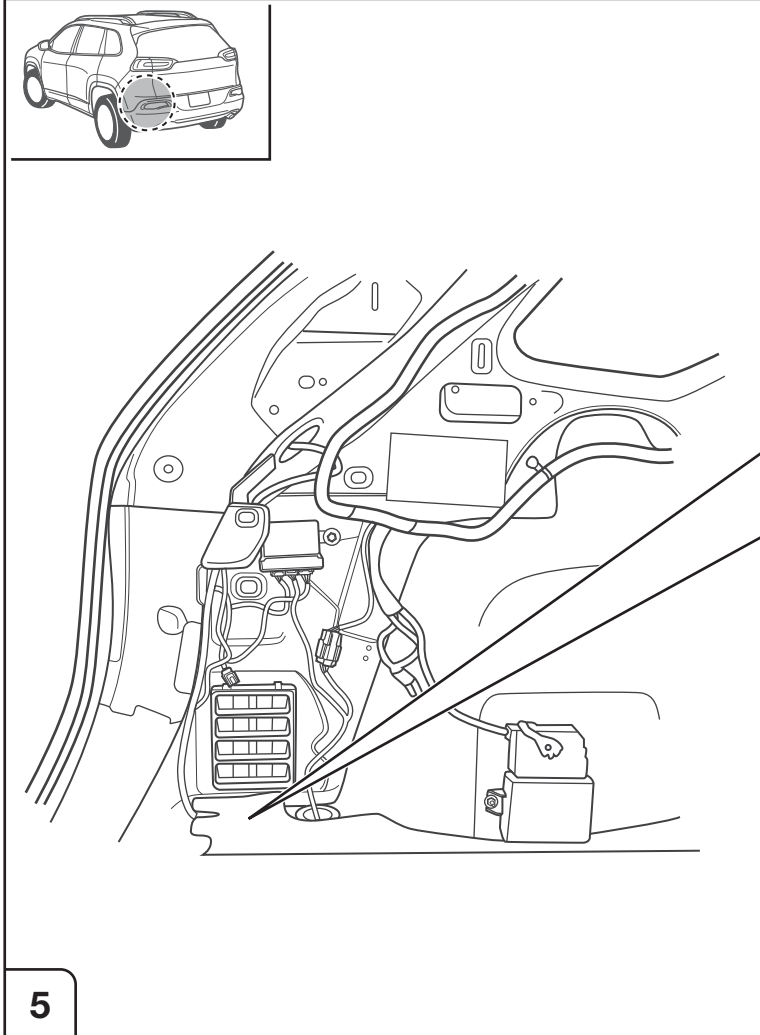
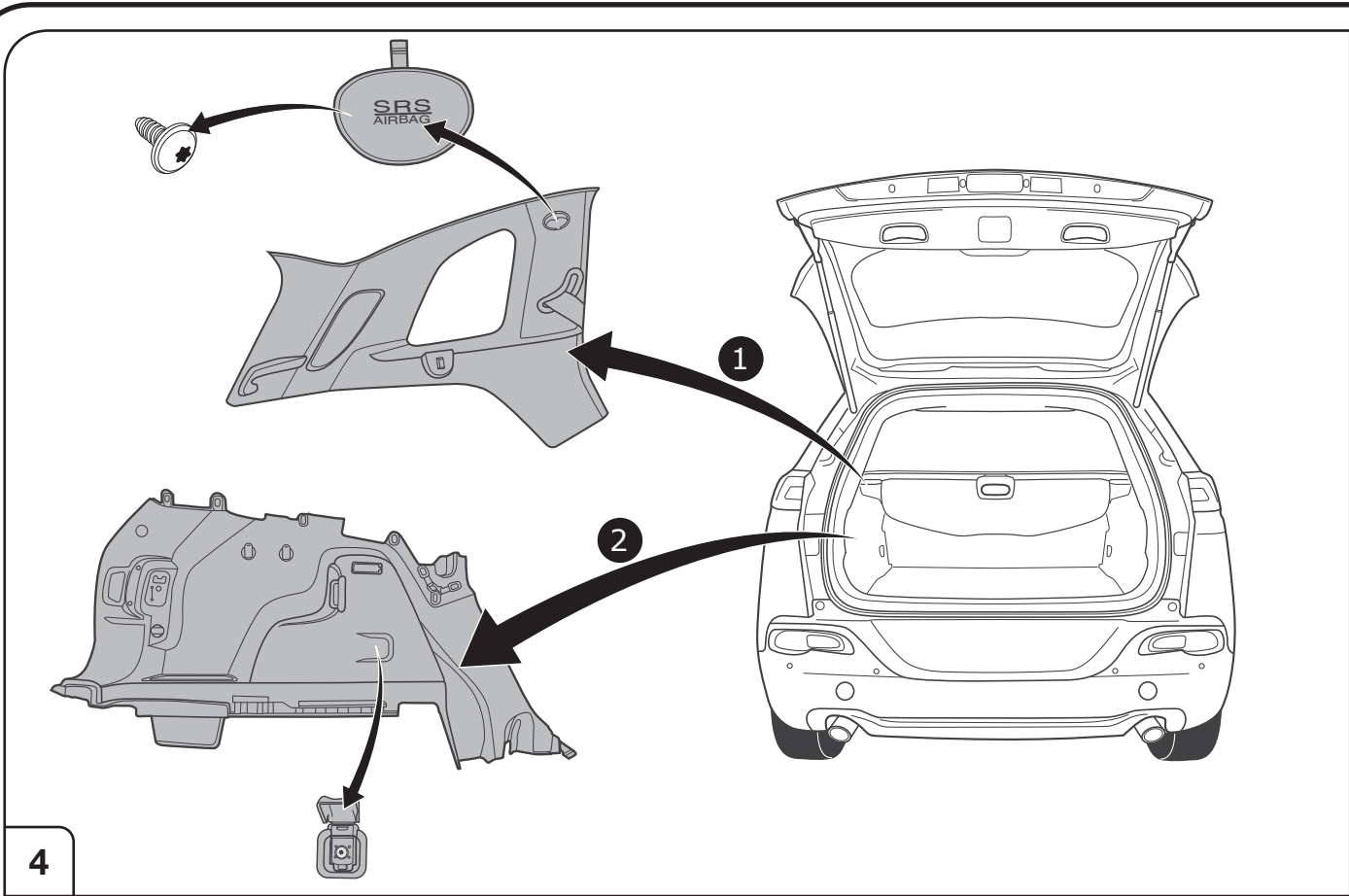

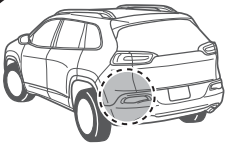

2

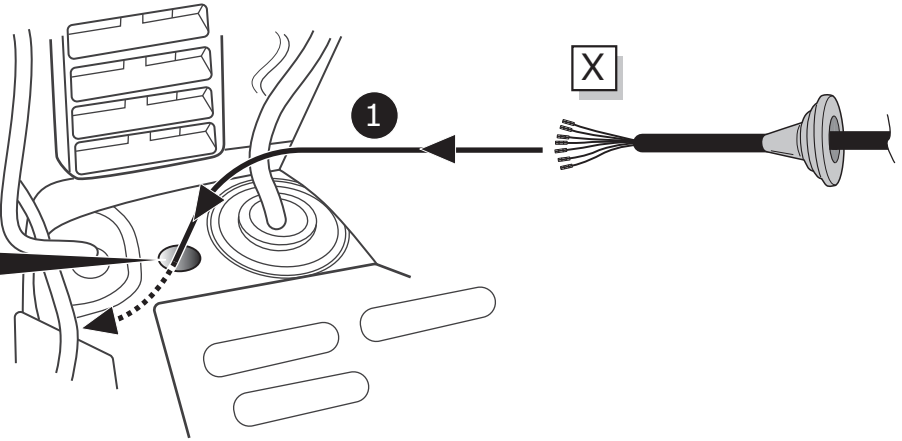

6

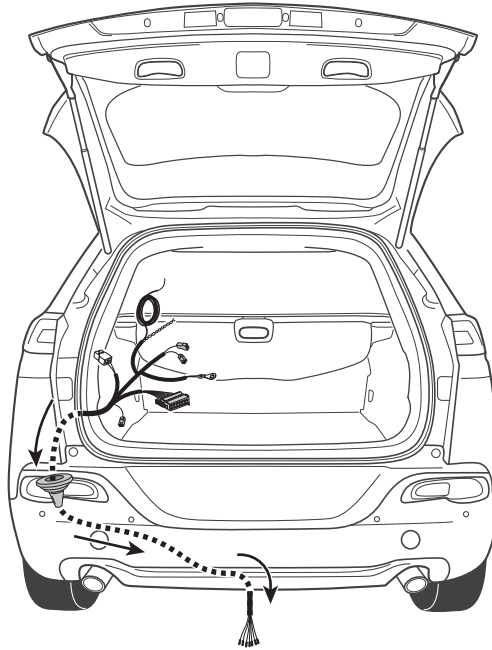

7

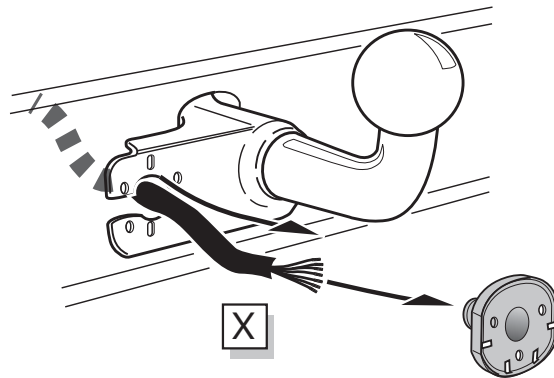

8

SOCKET CONNECTION



Page 15

9

10

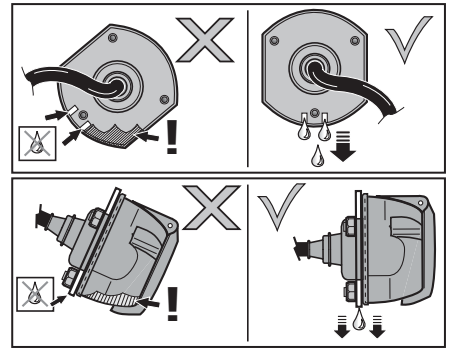
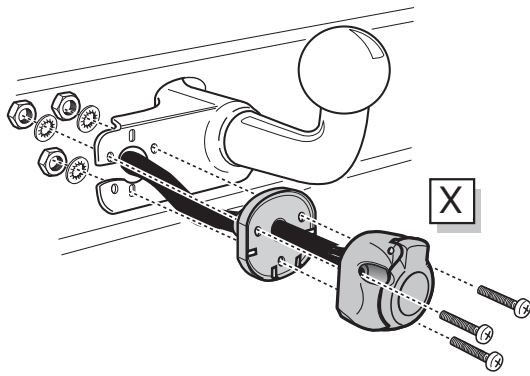

11

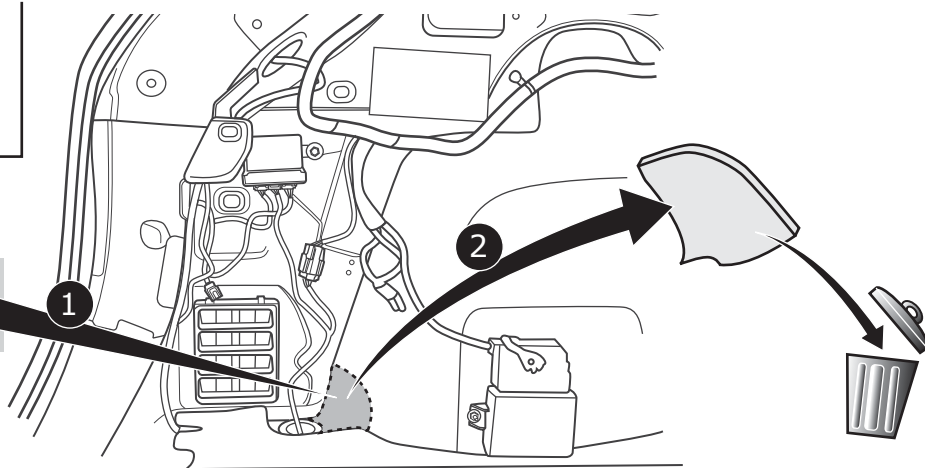
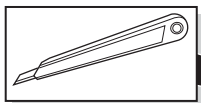
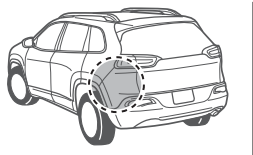

12

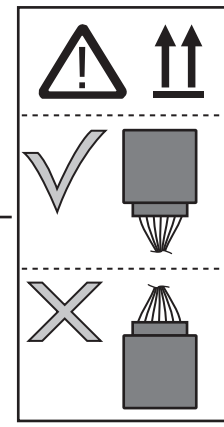
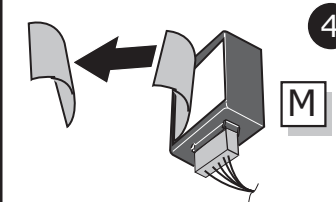
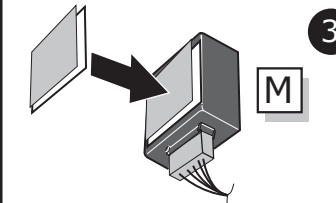
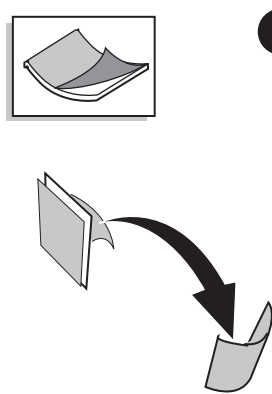
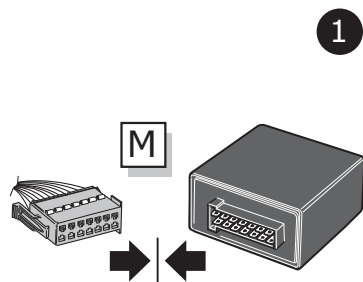

13

! Important!
Please note informations in picture 1!

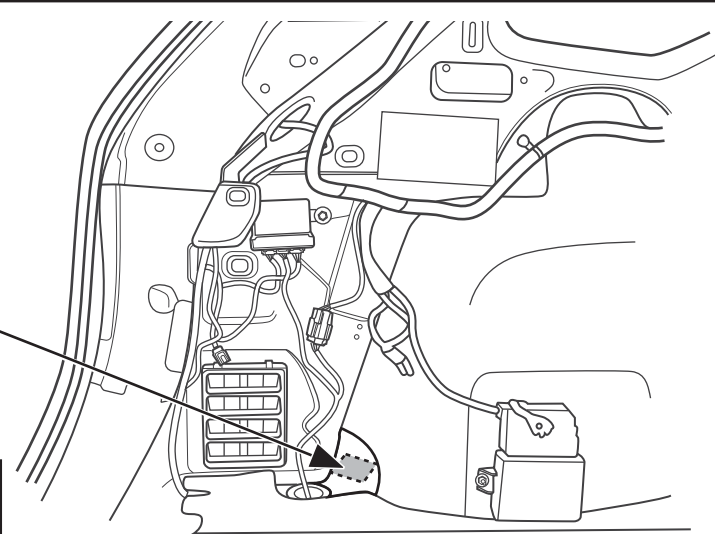
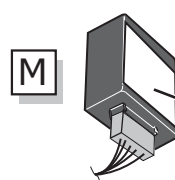
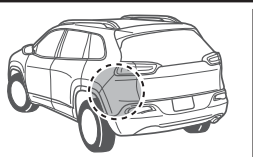

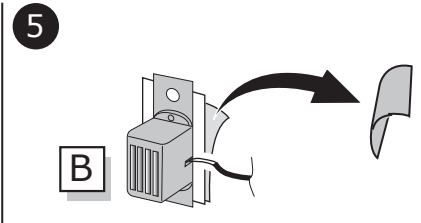
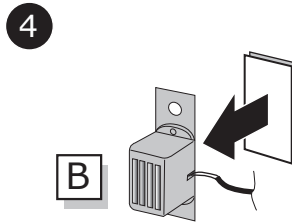
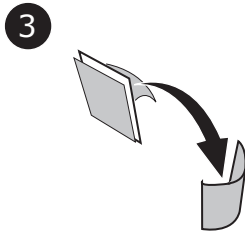
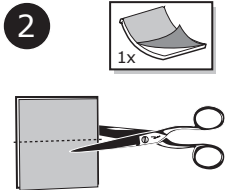
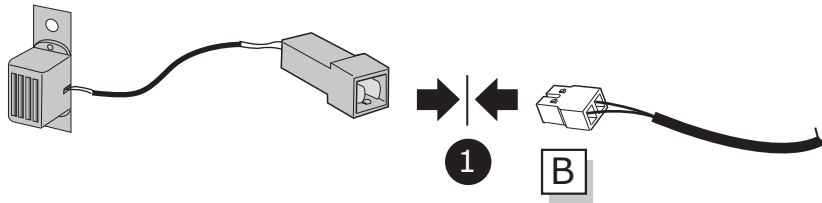

14

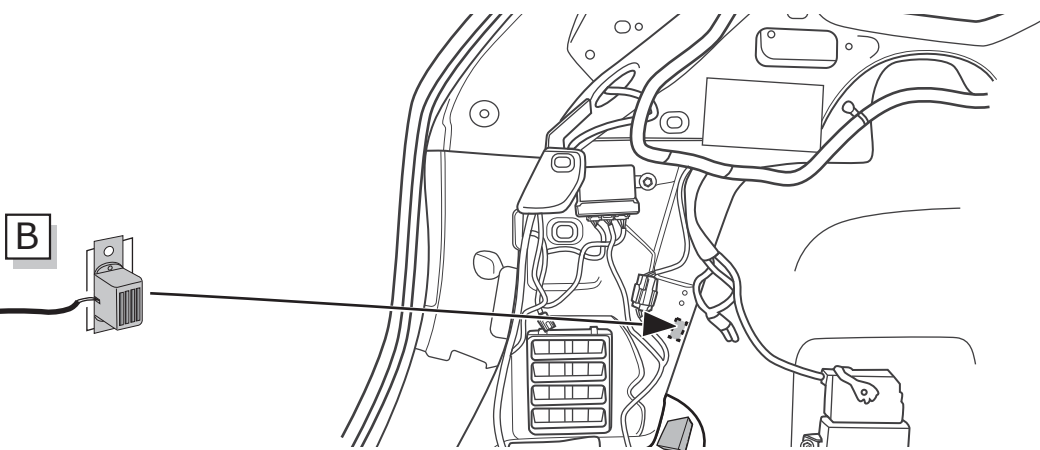
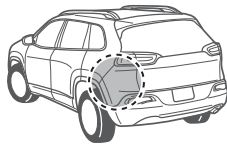

15

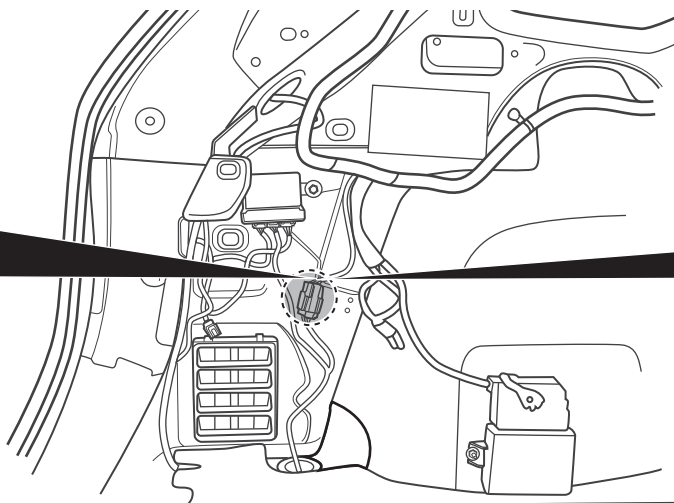
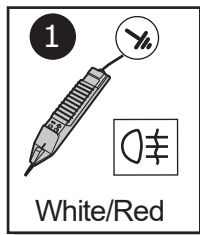

Grey
12-pin

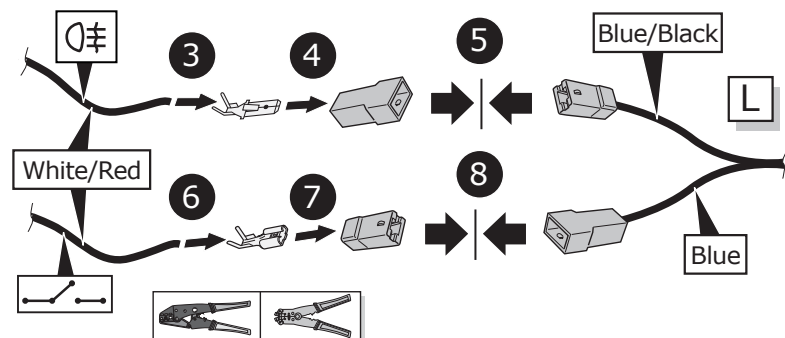
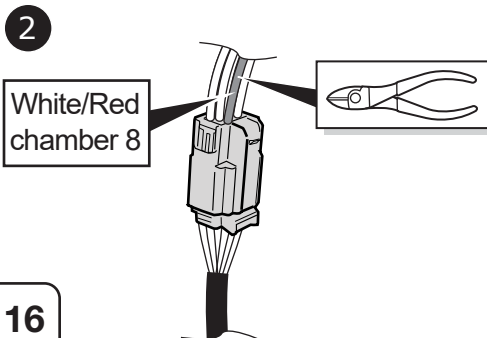

16

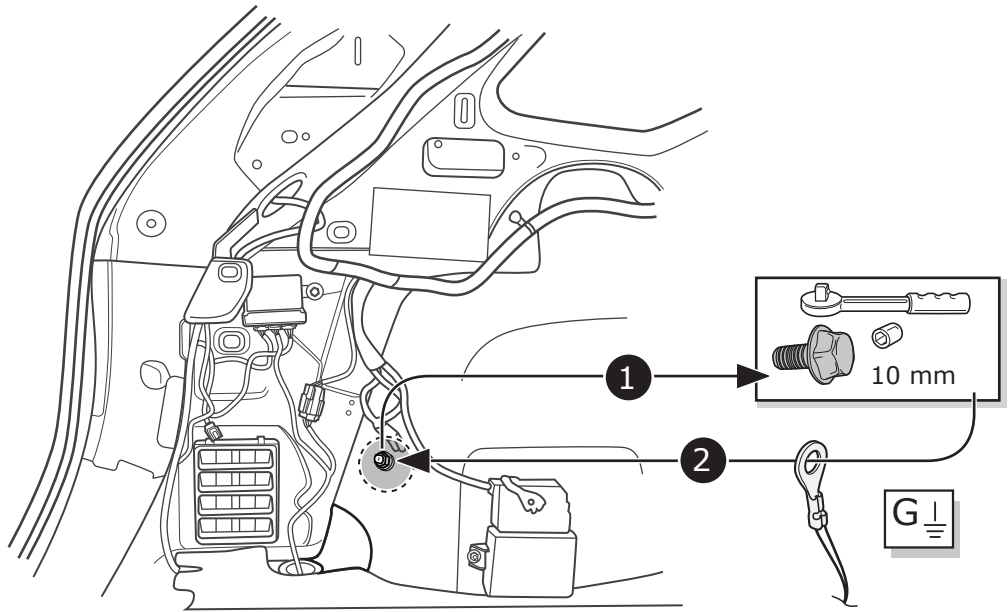

17

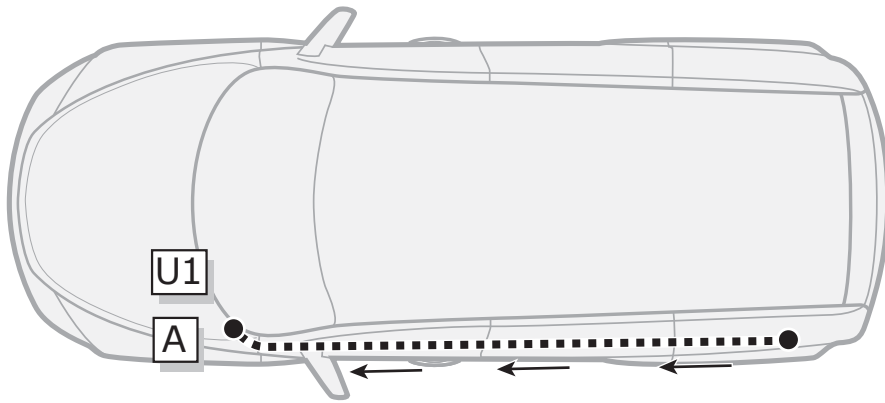

18

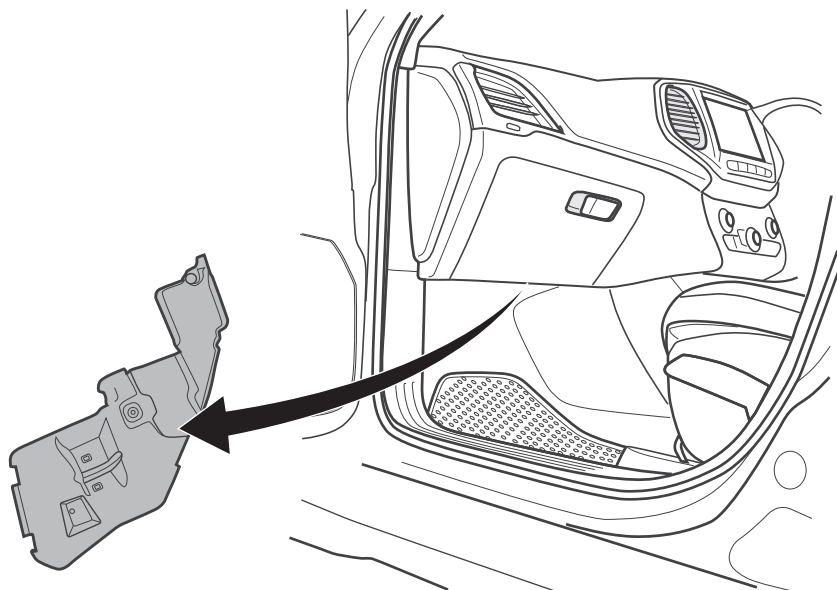

19

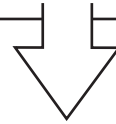
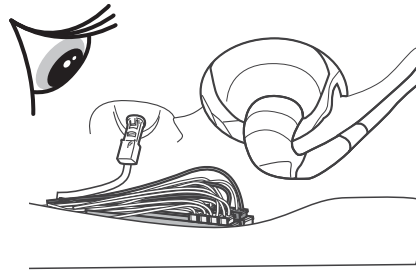
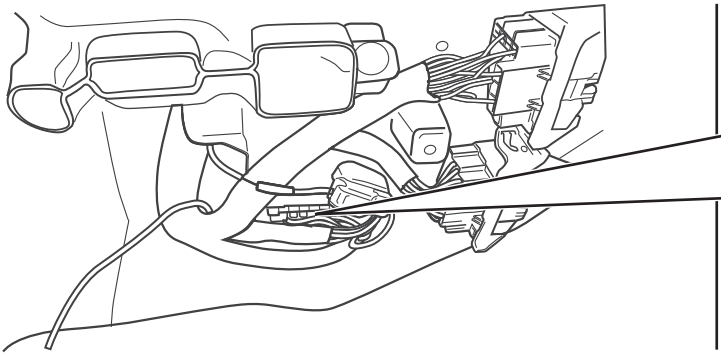

! Important!
Please note informations in picture 1!

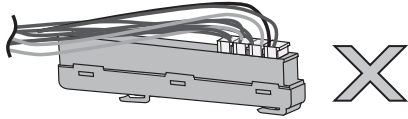

Manifold green

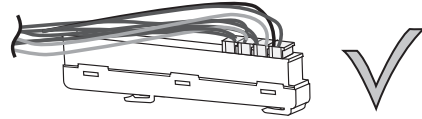

Manifold white

20

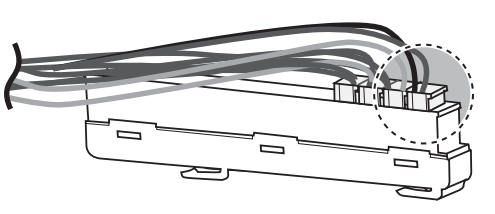

! Important!
Please note informations in picture 1!

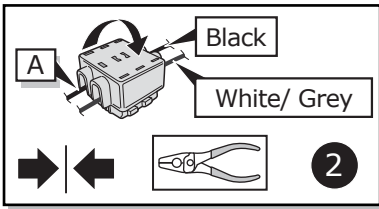

White/Grey

White/Orange

Black

Yellow

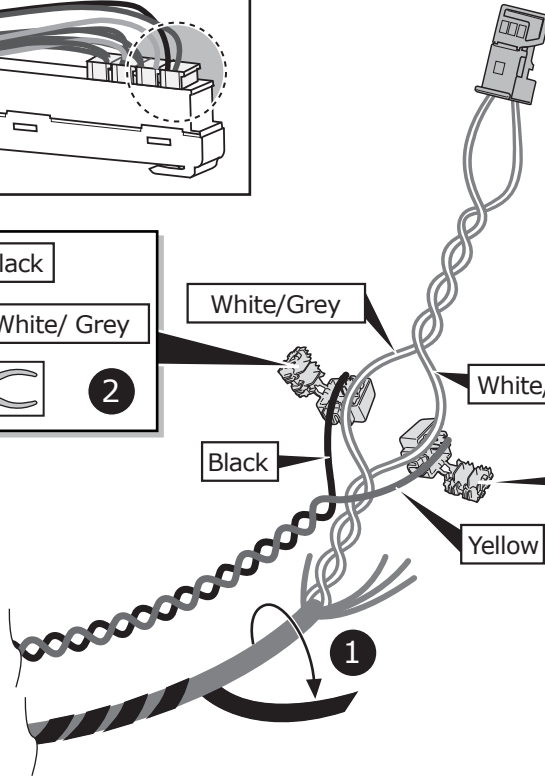
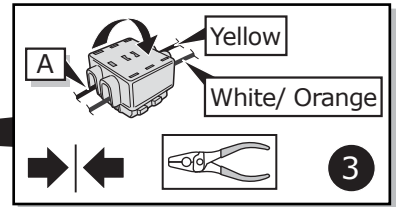

21

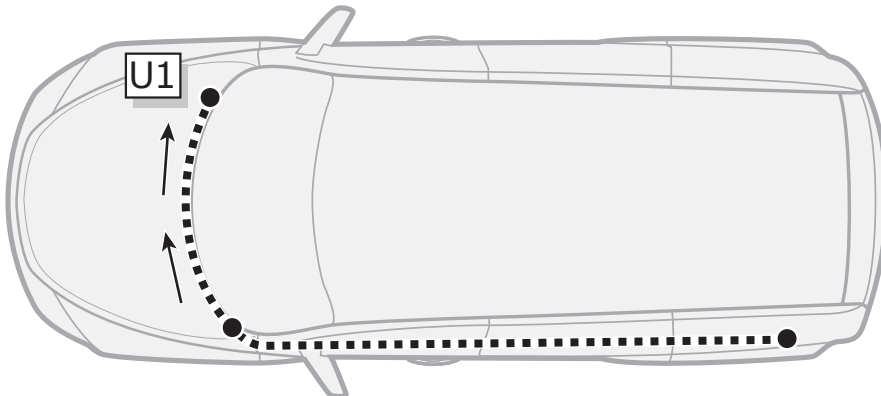

22

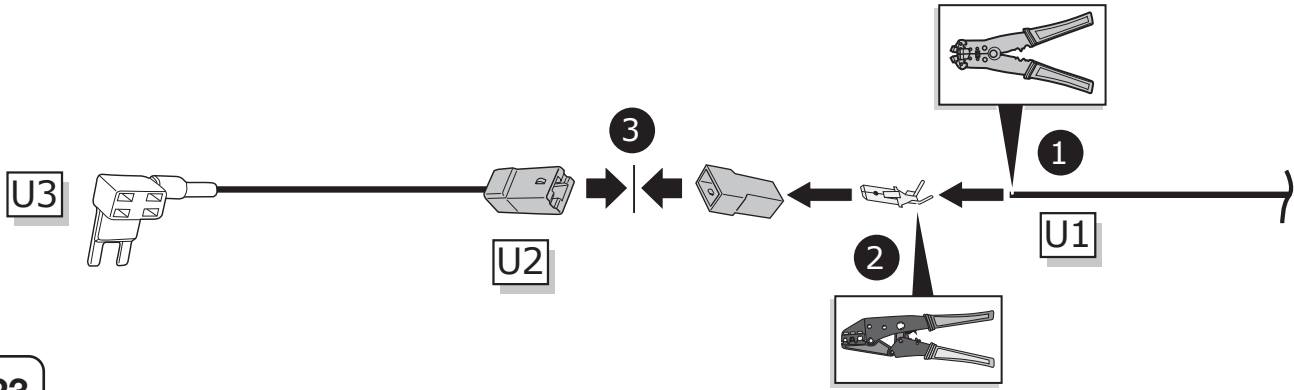

23

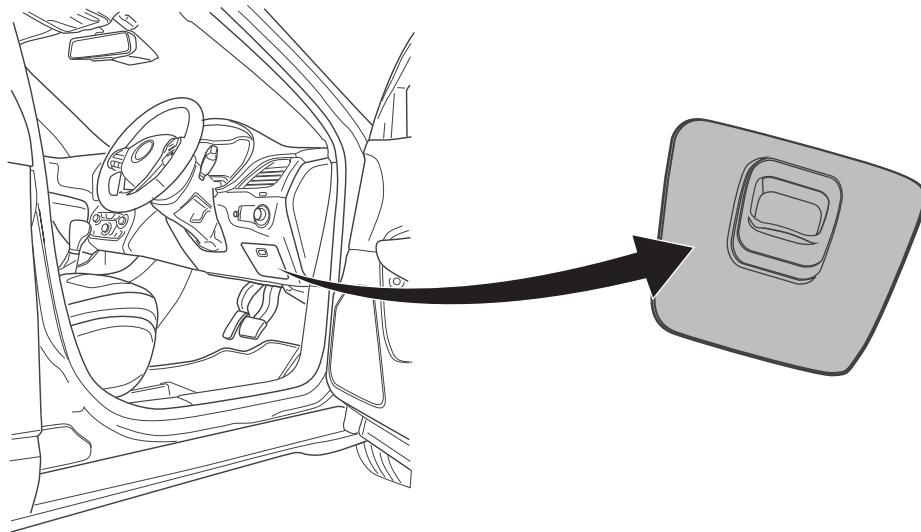
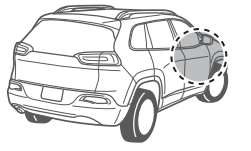

24

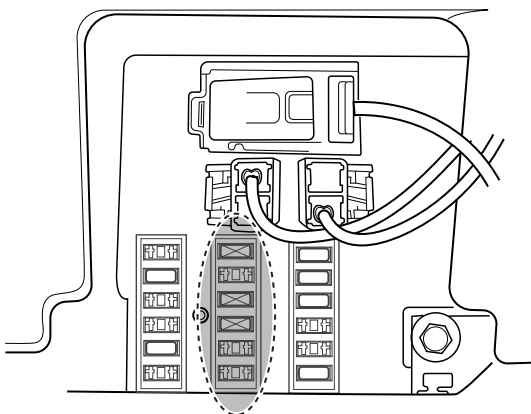

Option 1

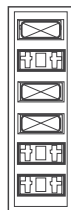

unoccupied plug-in positions available



26

Option 2

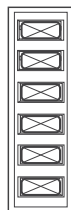

No plug-in position available



27

25

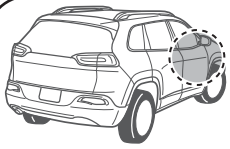

Option 1

U3

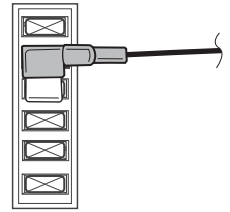
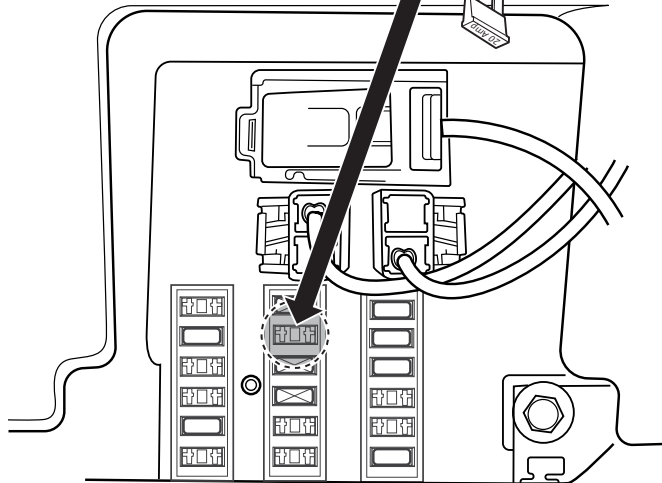
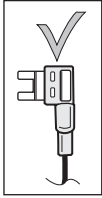
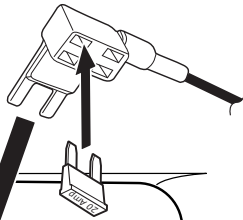

Important!
Please do not mount the fuse tap
and its wiring output in the other
direction!

26

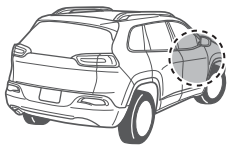

Option 2

U3

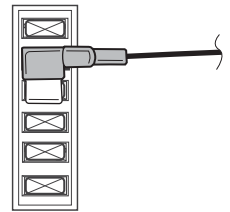
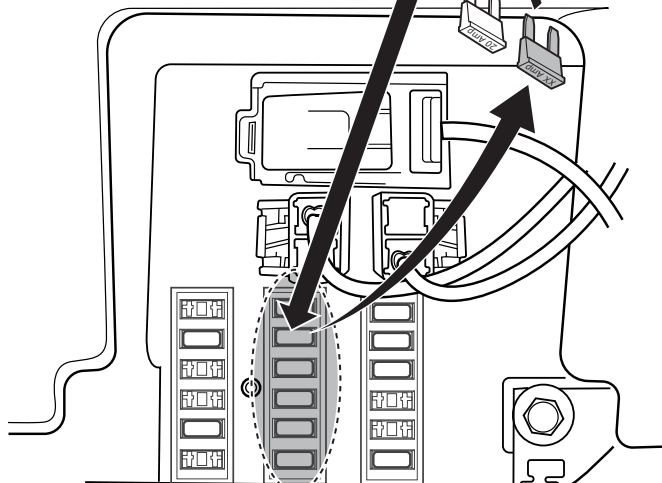
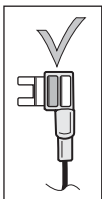
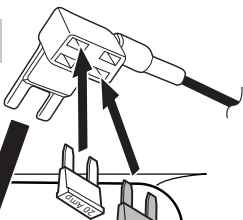

Important!
Please do not mount the fuse tap
and its wiring output in the other
direction!

27

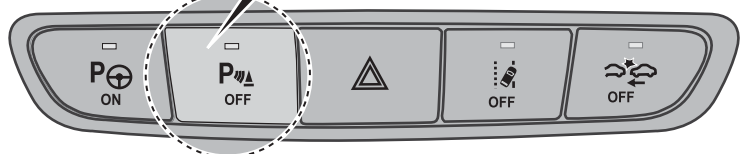
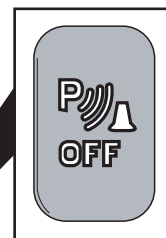
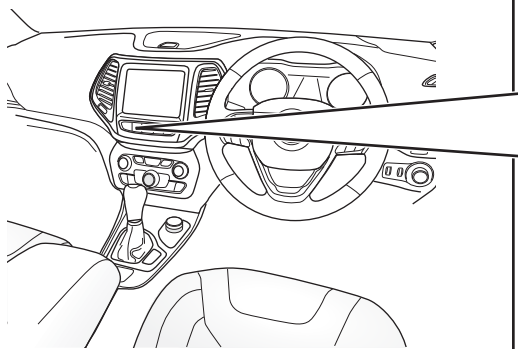

28

Optional

! MAX = 21W

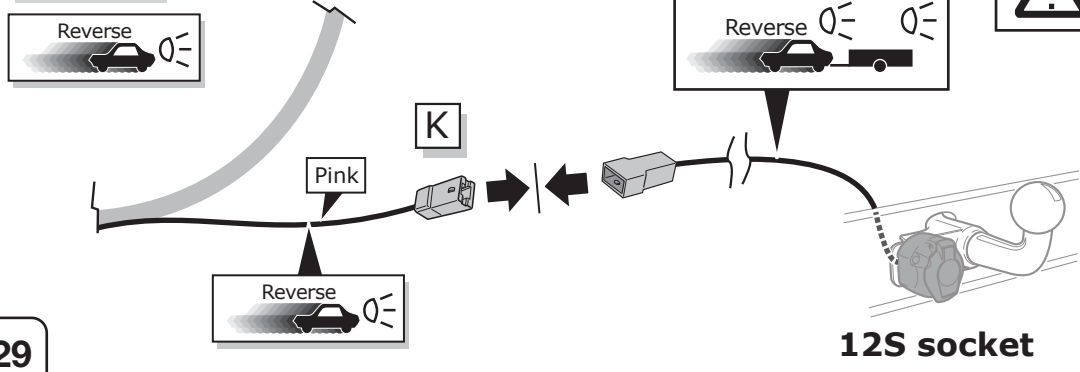

29

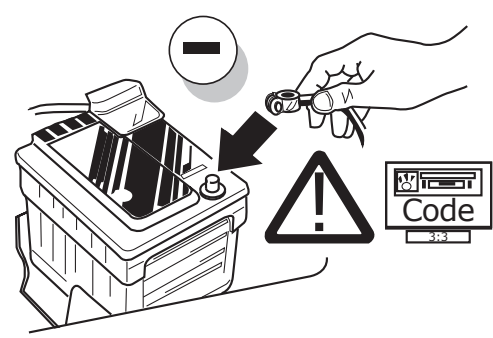

30

Functional test

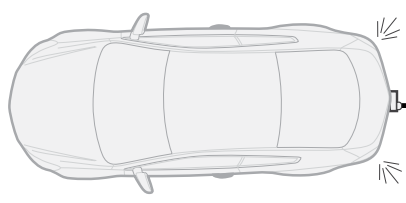
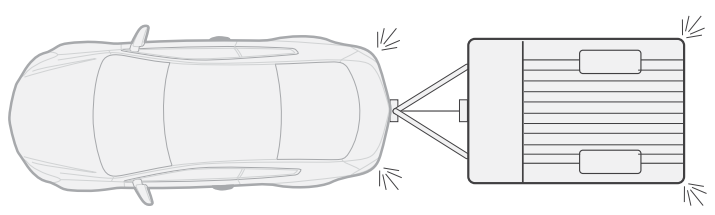
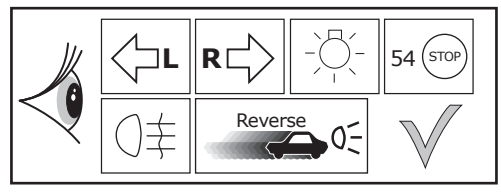

31

! **WARNING**

LIGHT MATE

ECS part no.
LIGHTMATE II
LIGHTMATE III

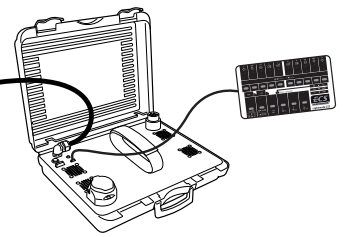

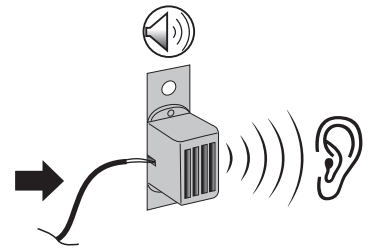
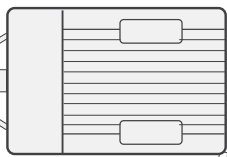
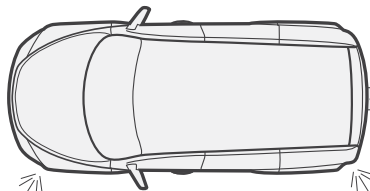

32

Optional

Adapter socket

7-pin

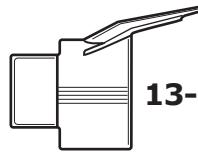

13-pin

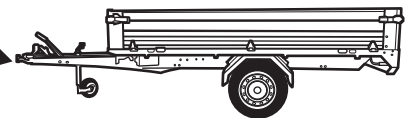
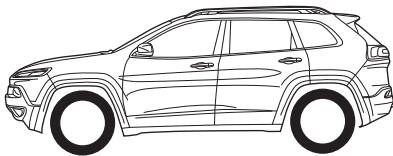

33

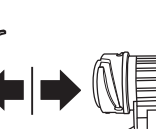
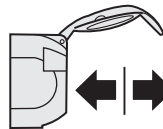
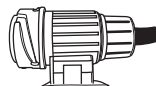
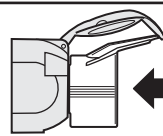
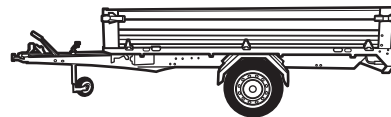
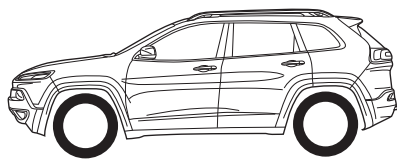

34

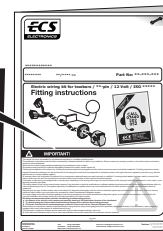
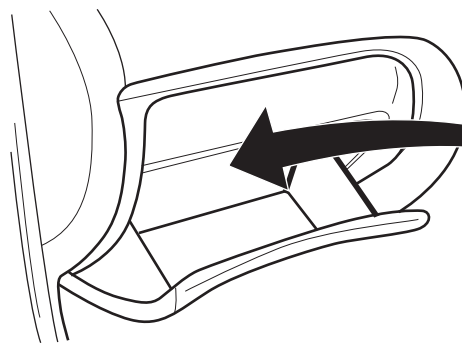

35

SOCKET CONNECTION

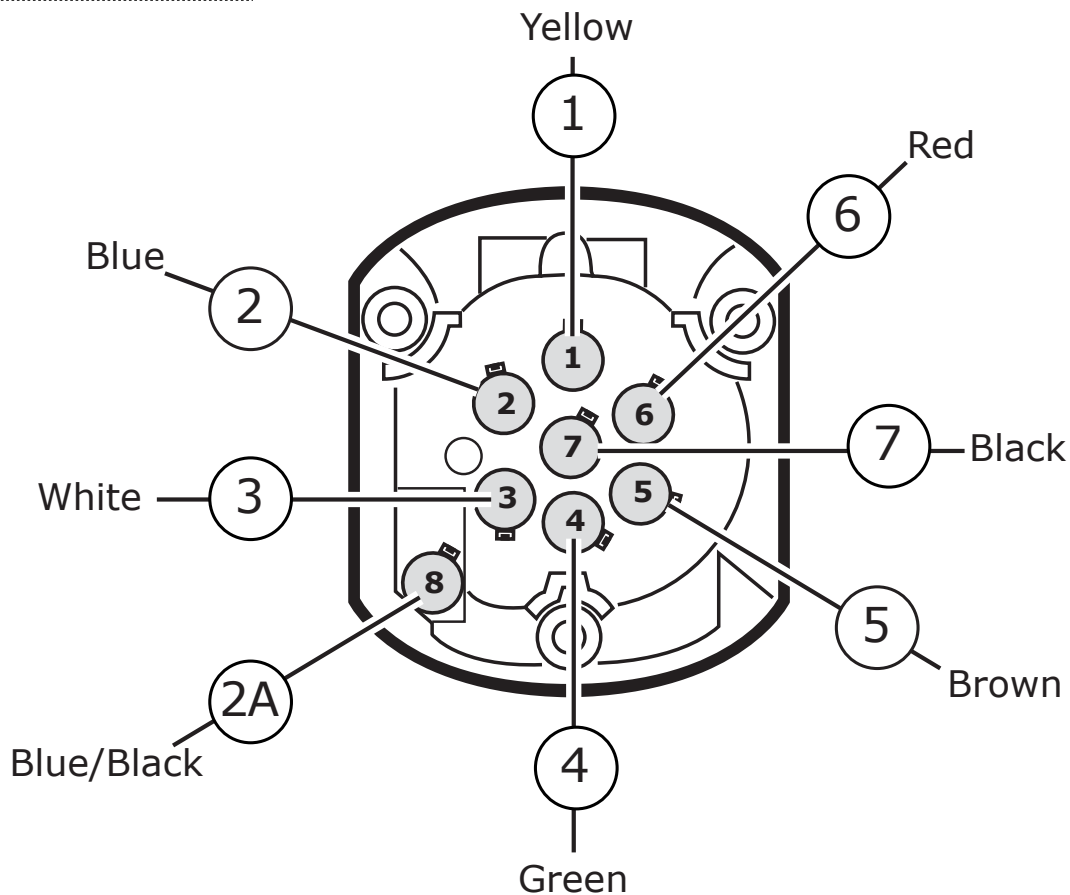
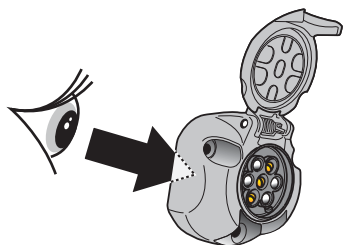

SOCKET CONNECTION

DIN/ISO 1724								
Pmax	21W	21W			21W	52W	3x21W	52W
	Yellow	Blue	Blue/Black	White	Green	Brown	Red	Black