

## Nissan Micra (K13) 07/2013-

Partnr.: NI-116-DHU

- Fitting instructions electric wiring kit tow bar with 13-P socket up to DIN/ISO Norm 11446.
- We would expressly point out that assembly not carried out properly by a competent installer will result in cancellation of any right to damage compensation, in particular those arising by virtue of the product liability act.
- Contents of these kits and their fitting manuals are subject to alteration without notice, please ensure that these instructions are read and fully understood before commencing installation.
- Do not overload circuits; the maximum loads per connection are detailed in this manual.
- Attention! Before Installation, please read this manual carefully and inform your customer to consult the vehicle owners manual to check for any vehicle modifications required before towing.
- In the event of functional problems, troubleshooting must be limited to about 0.5 hours, contact the technical support:  
[t.skinner@ecs-electronics.com](mailto:t.skinner@ecs-electronics.com) / 07440 202 052.



# Part list

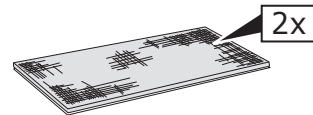
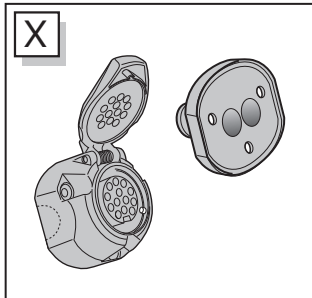
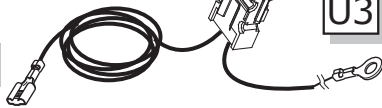
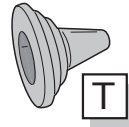
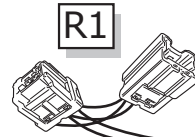
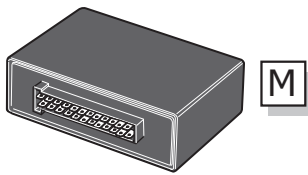
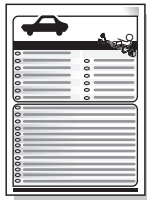
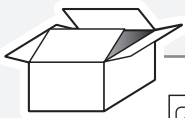

**Option!**

PARK DISTANCE CONTROL



PARK DISTANCE CONTROL

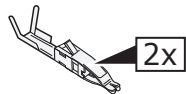

Pag. 10

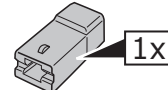
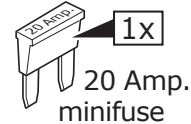
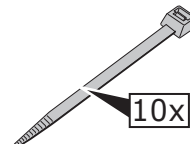
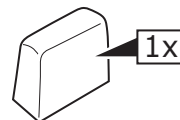
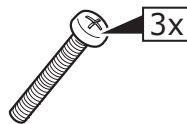

**ROUTING**

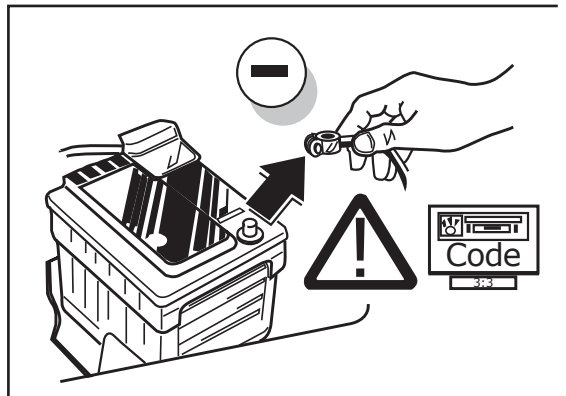
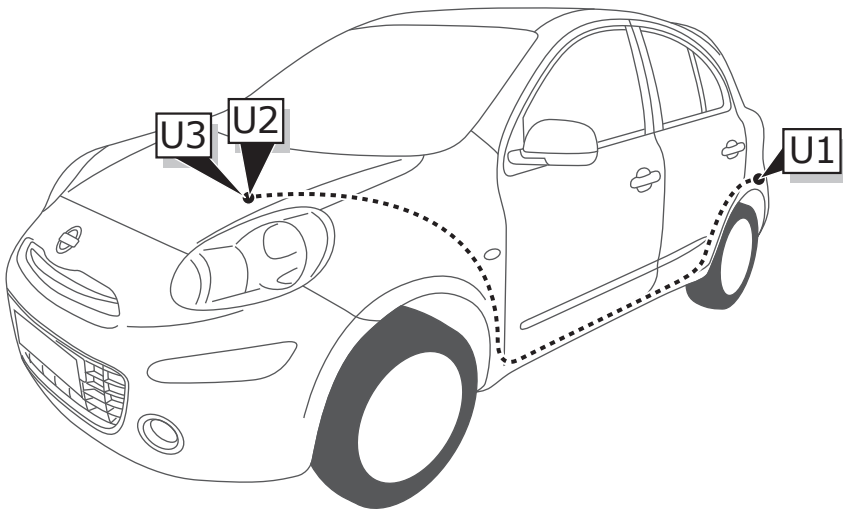
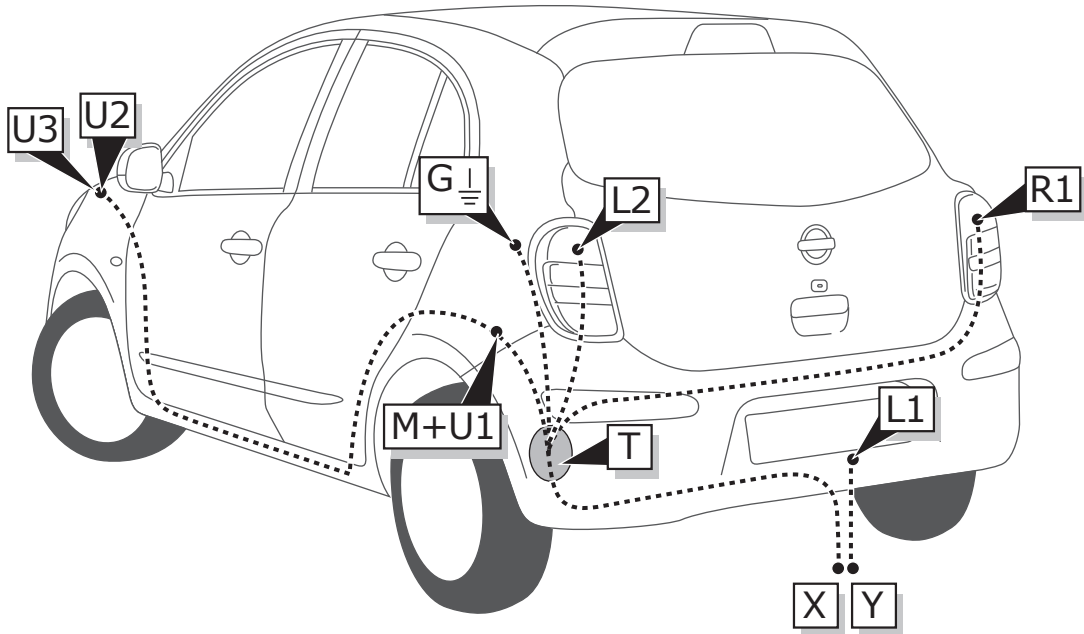

**1**

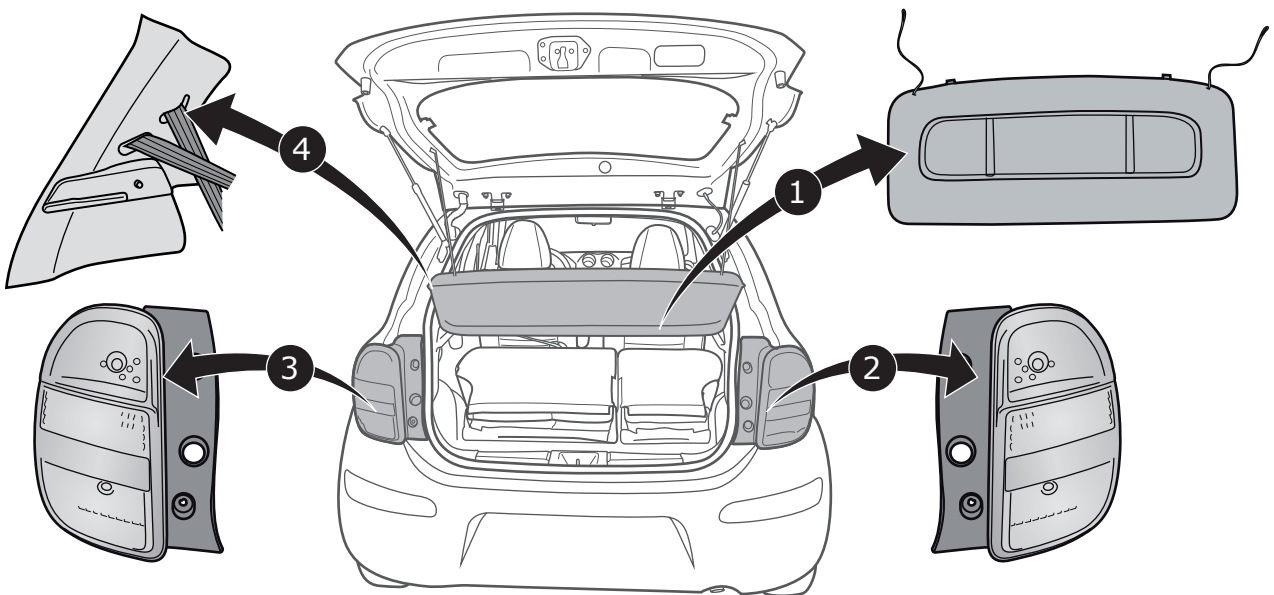

2

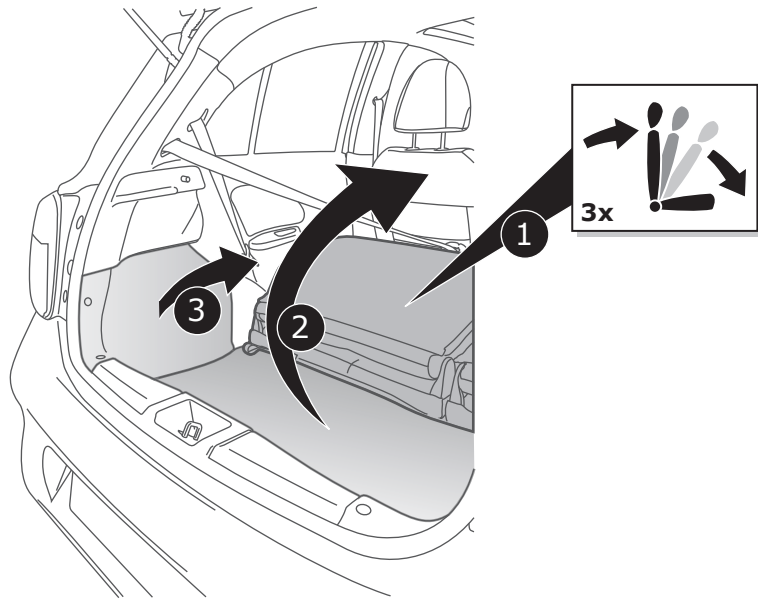

3

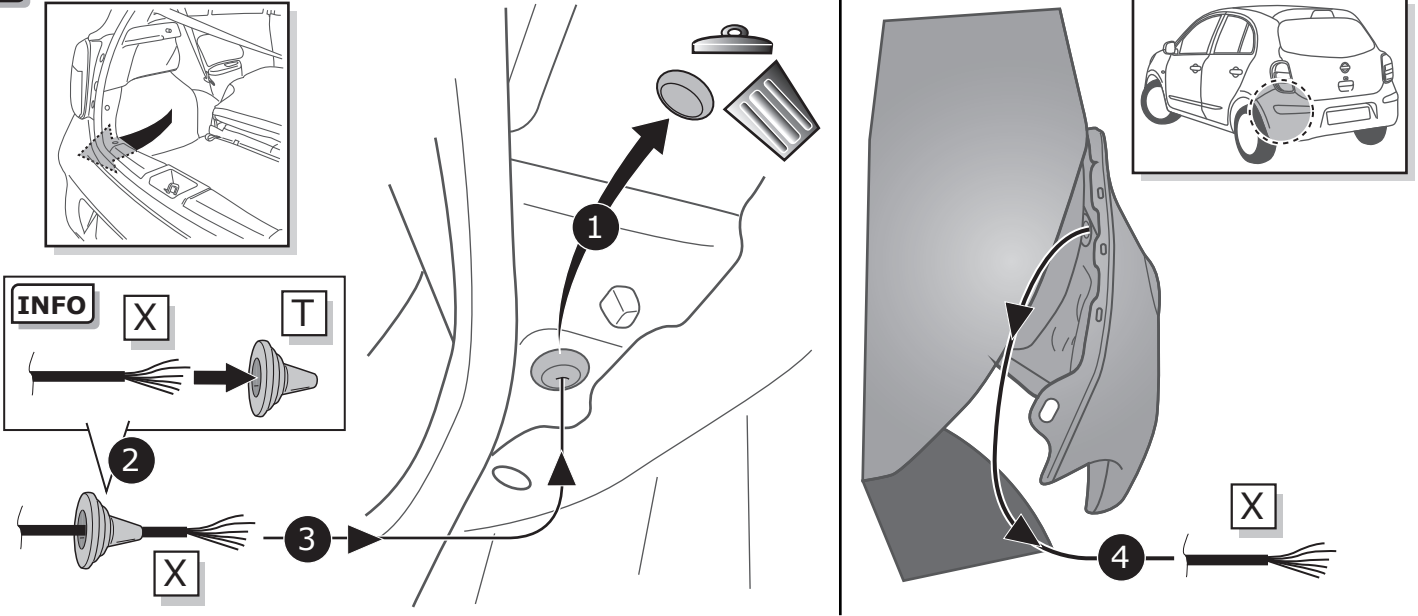

4

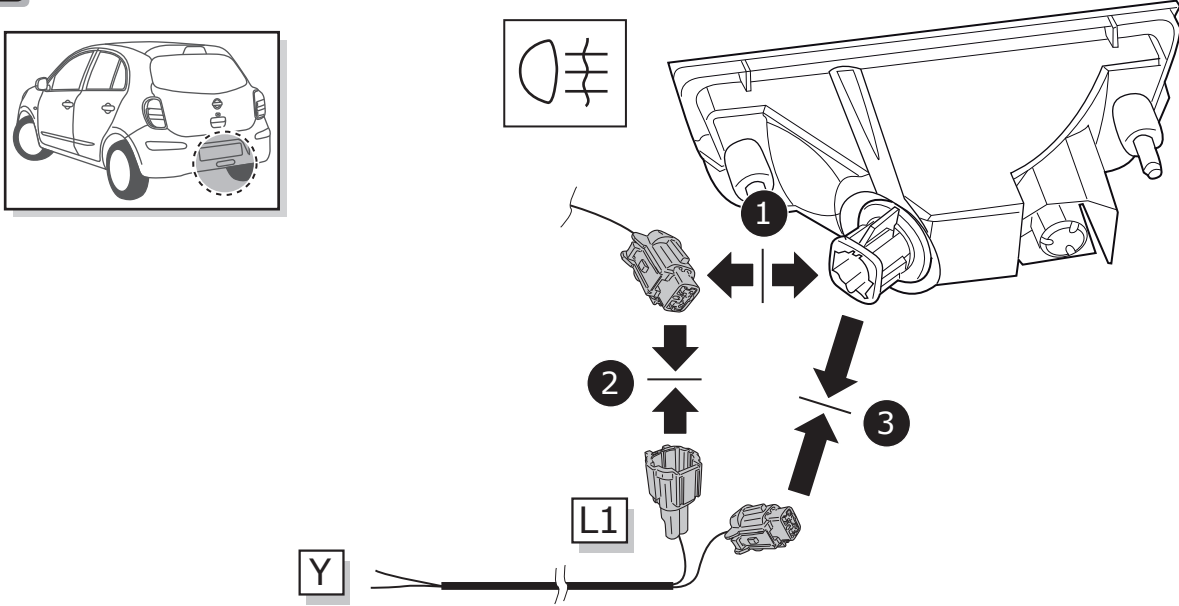

A

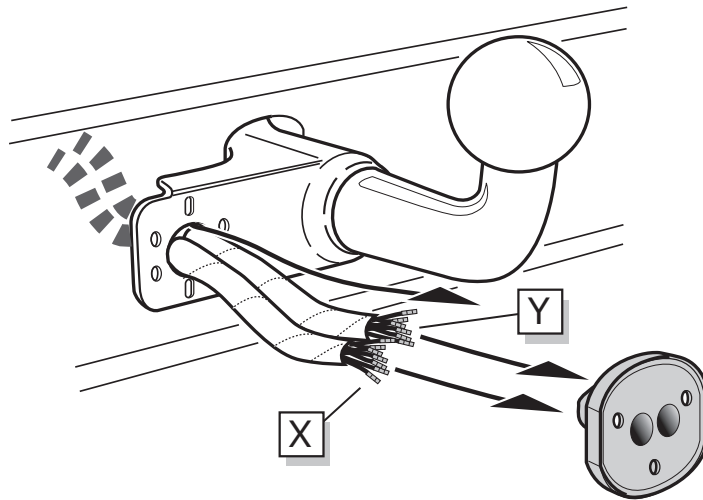

INFO

SOCKET CONNECTION  **Pag. 9**

B

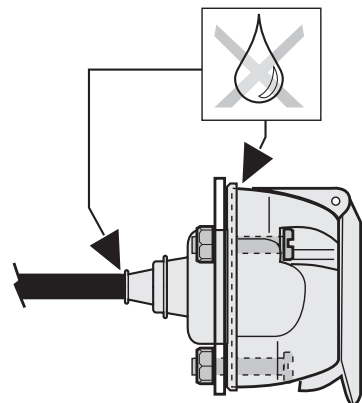
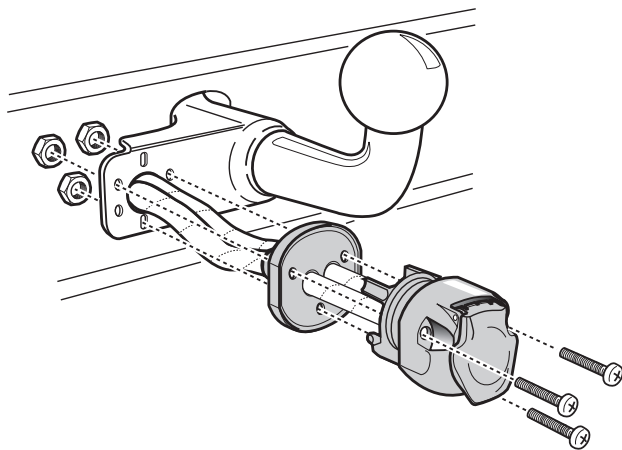

5

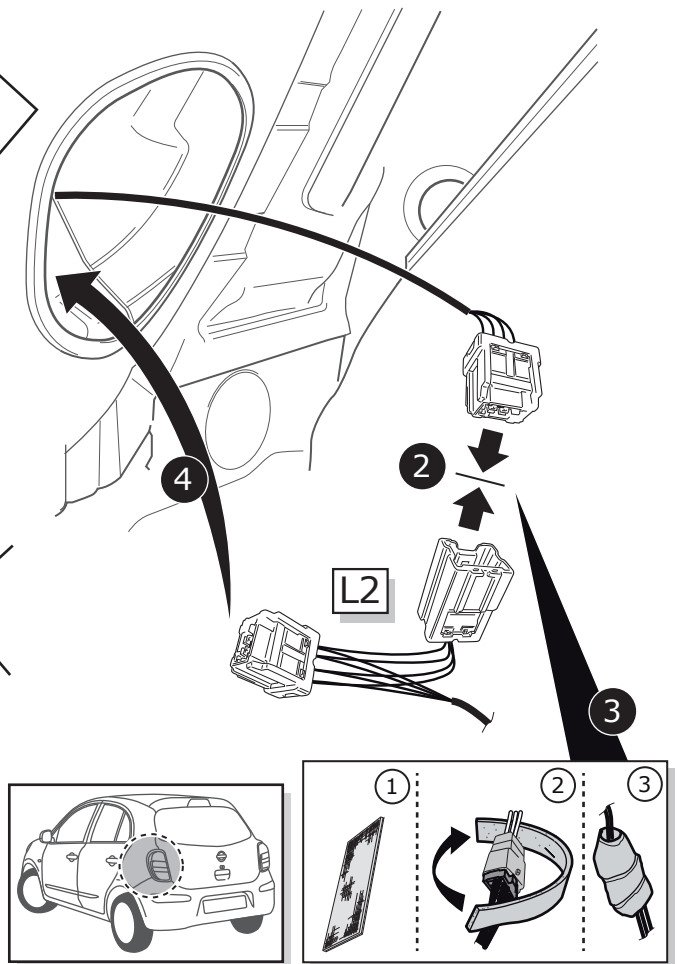
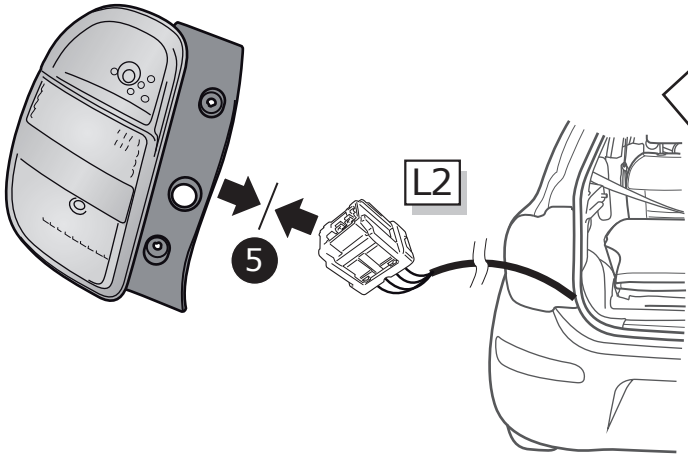
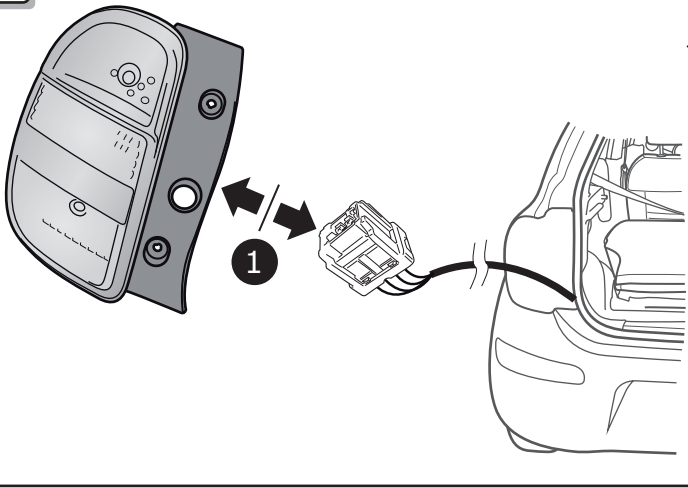

6

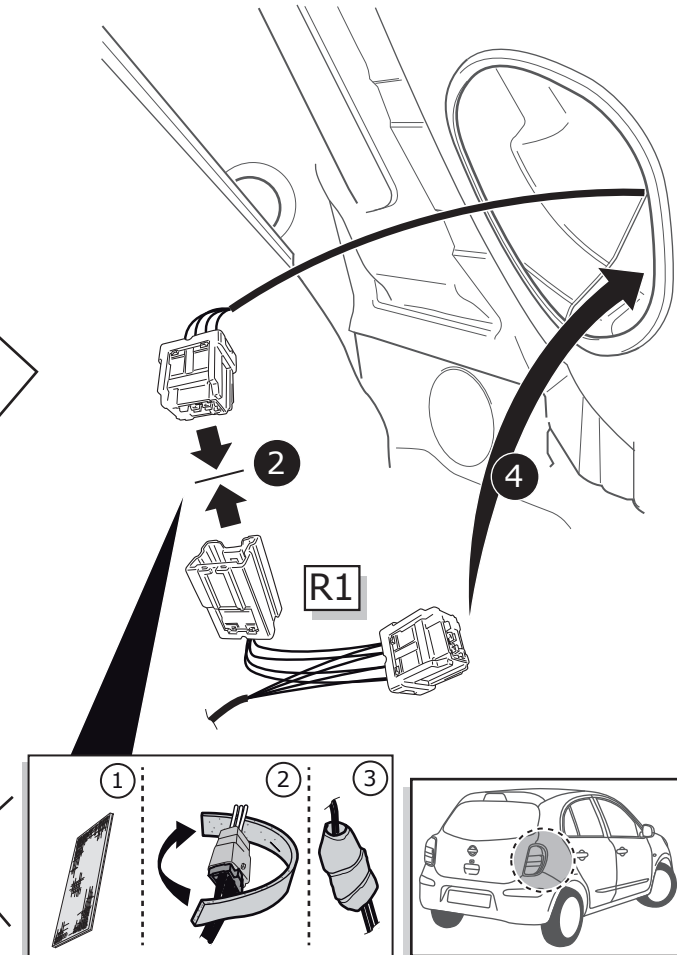
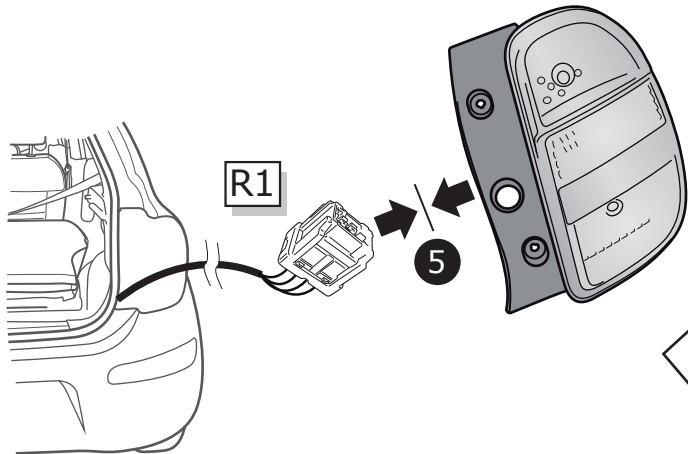
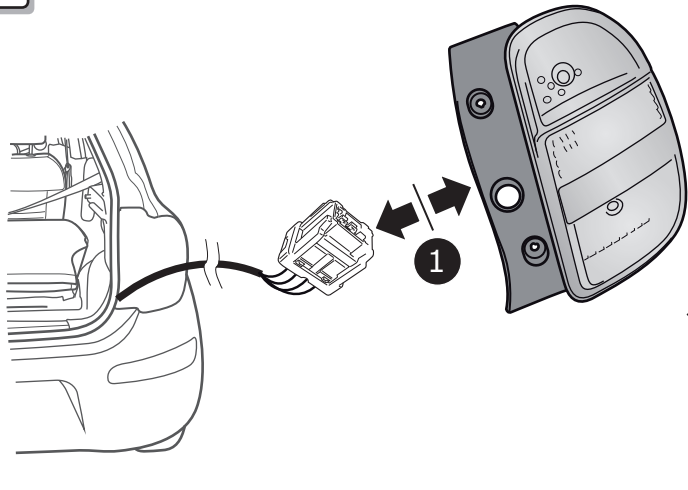

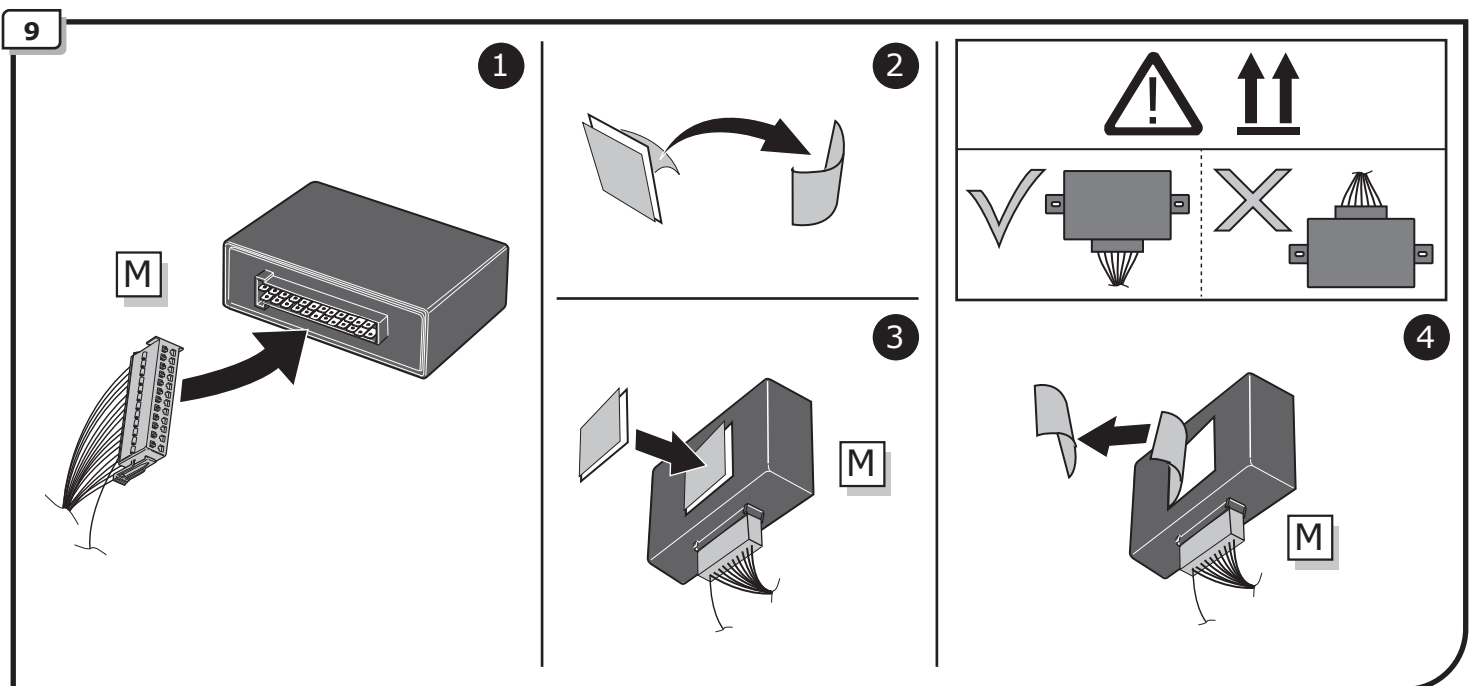
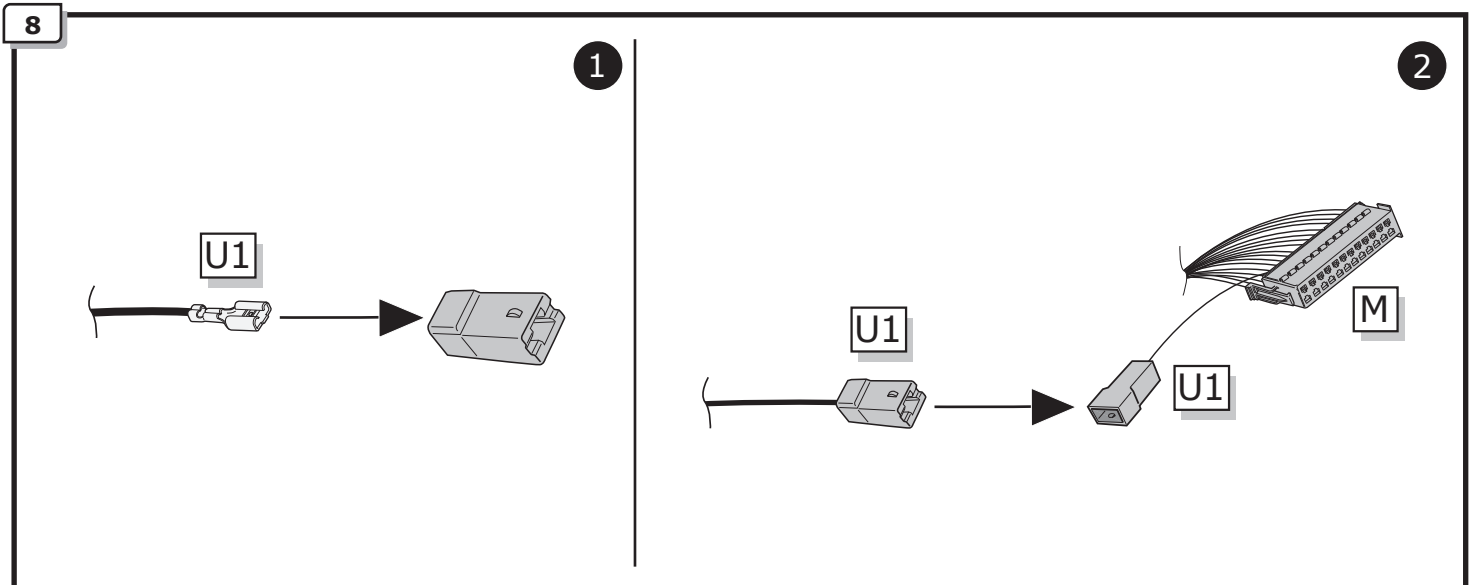
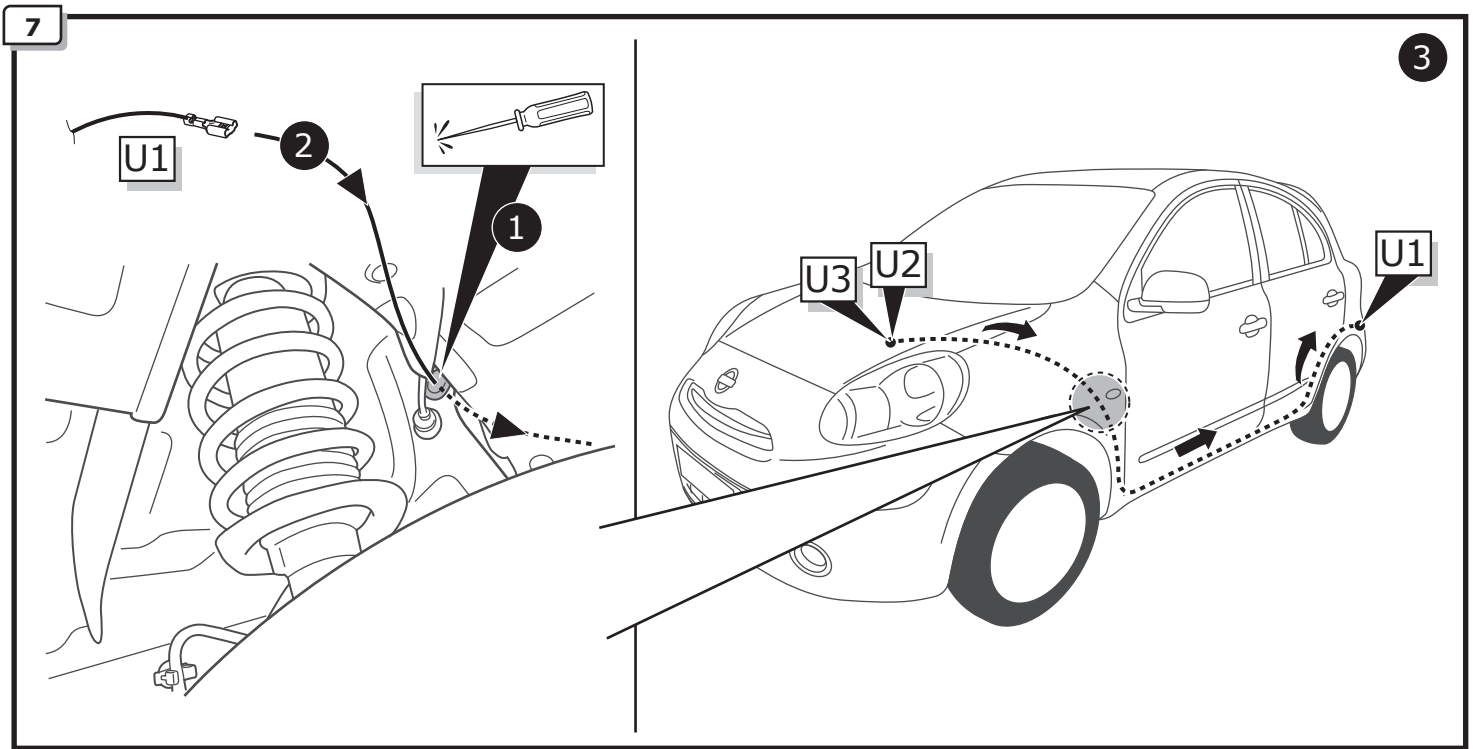



10

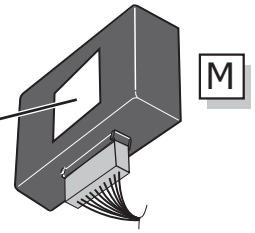
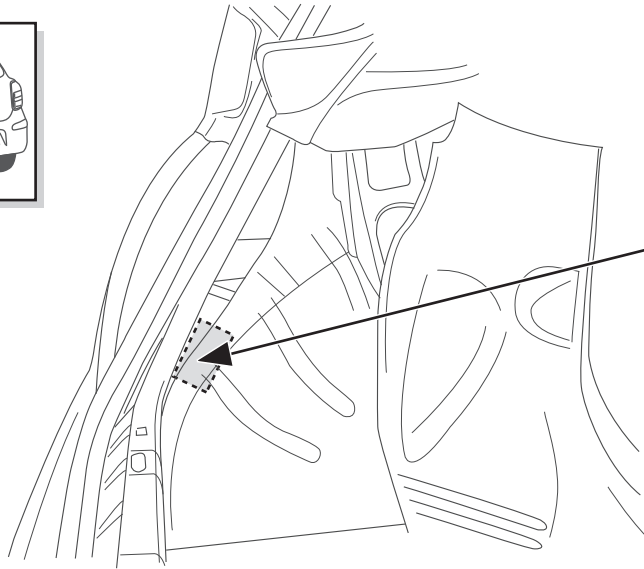
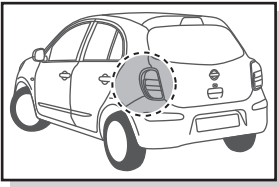

11

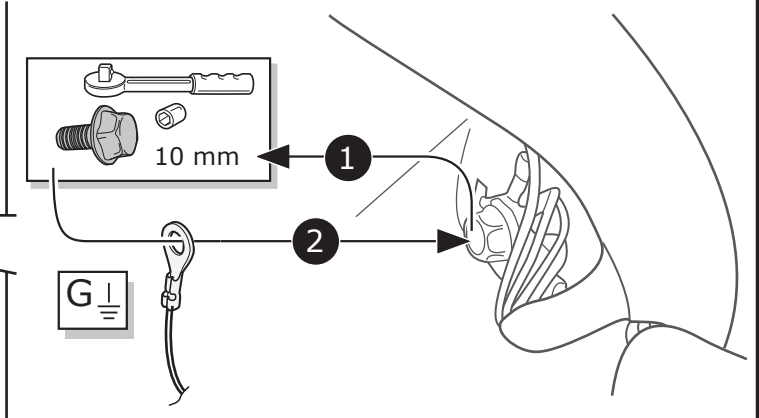
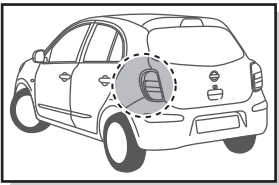

12

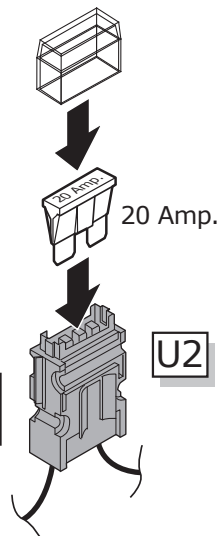
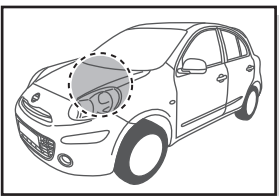

1

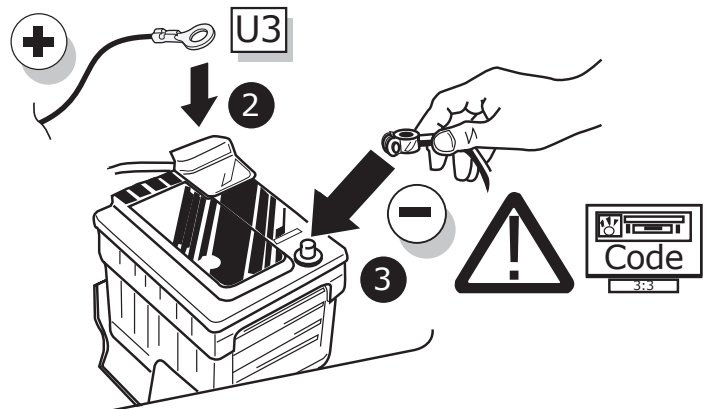



TEST ALL THE CIRCUITS WITH A TEST DEVICE WITH THE CORRECT POWER LOAD FOR EACH FUNCTION. A TEST DEVICE WITH LED'S CANNOT BE USED FOR THIS PURPOSE.

INFO

REINSTALL TRIM.

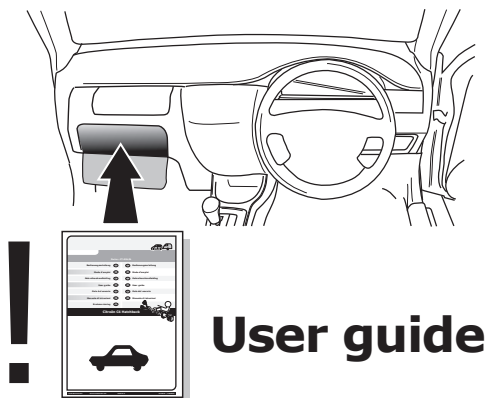

INFO

SOCKET CONNECTION

DIN/ISO 11446														
	1/L	2	2a	3/31	4/R	5/58-R	6/54	7/58-L	8	9	10	11	12	13
Pmax	21W	21W			21W	21W	2x21W	21W	21W	180W/15Amp	180W/15Amp			
Colour	Yellow	Blue	Grey	White	Green	Brown	Red 1,00 mm <sup>2</sup>	Black	Black/ Red	-	-	-	-	-

