

! INFO !

Do not charge the battery of the towing vehicle and/or towed vehicle directly via the socket.

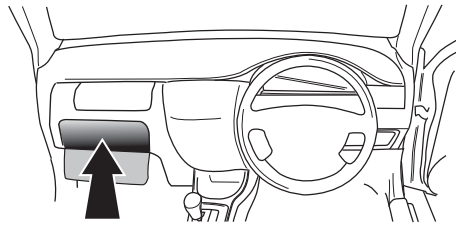

User guide

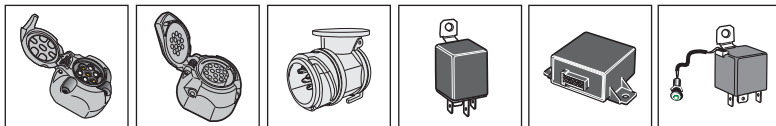

SPARE PARTS

www.ecs-electronicsuk.co.uk



Partnr.: PE-065-D1U

User Guide

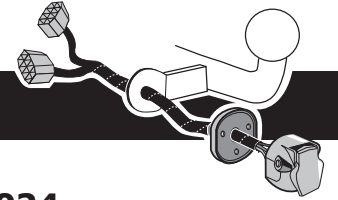

Citroën C3 12/2016 >> 08/2024

Citroën C3 Aircross 10/2017 >> 09/2024

Citroën C4 Cactus 07/2014 >> 02/2018

Citroën C4 Cactus 03/2018 >>

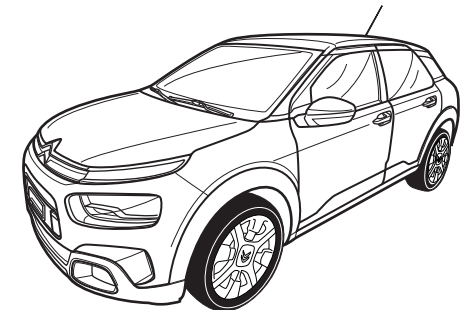
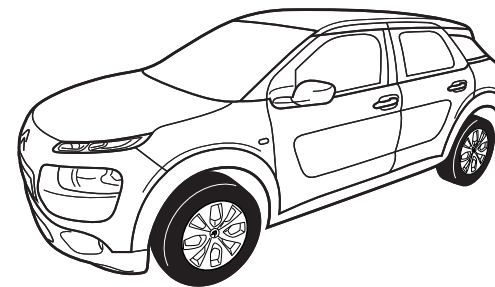
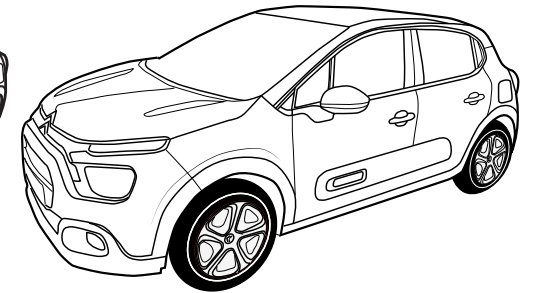
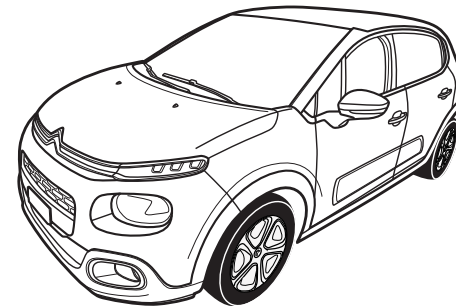

INFO

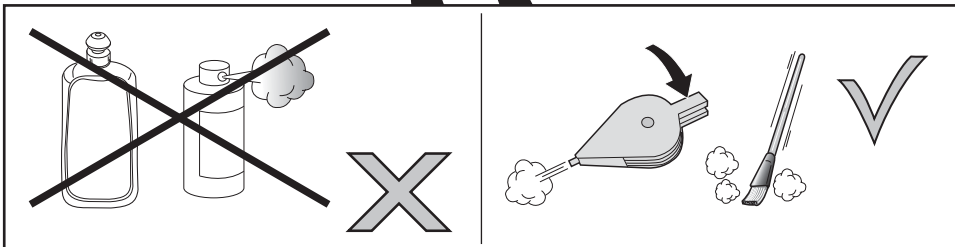
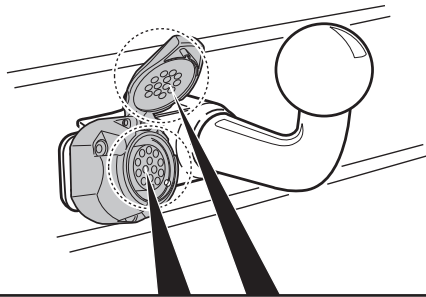
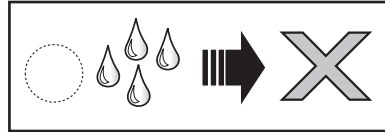
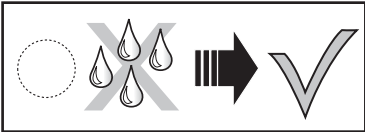
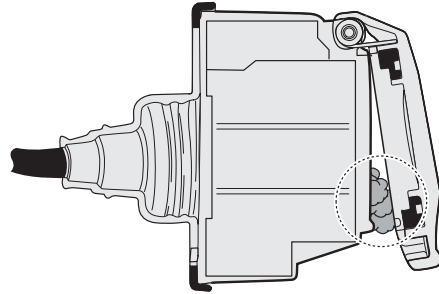
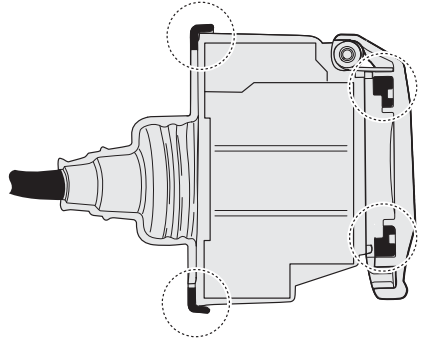
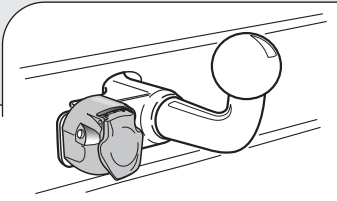
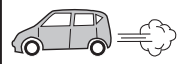

CHANGING THE FUSE

Citroën C3

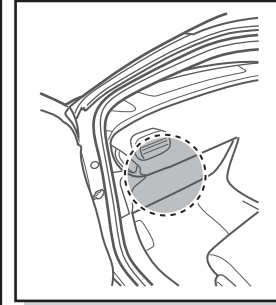

Pos. 36

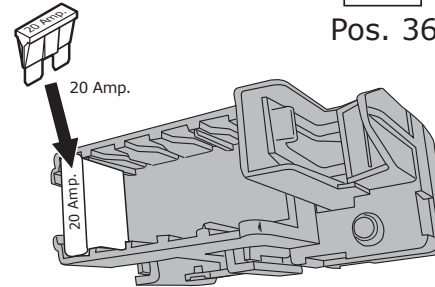

Citroën C4

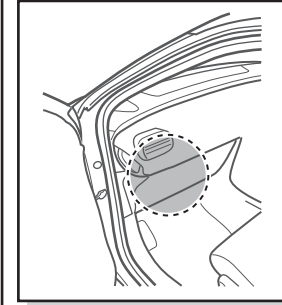

Pos. 40

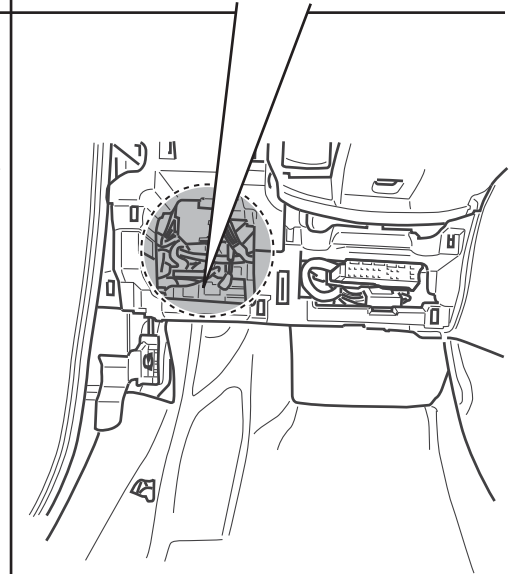
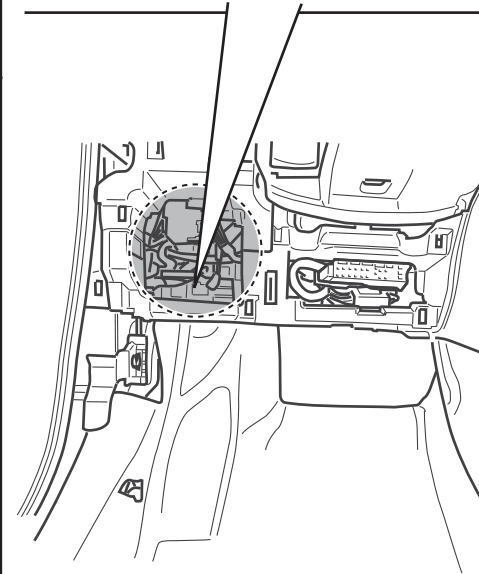
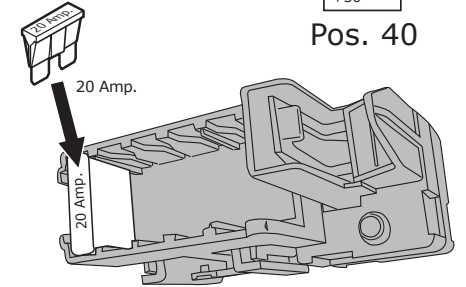

SOCKET CONNECTION

DIV/ISO 11446													
	1/L	2	3/31	4/R	5/58-R	6/54	7/58-L	8	9	10	11	12	13
Pmax	21W	21W		21W	42W	3x21W	42W	21W	180W/15Amp	180W/15Amp			
Colour	Yellow	Blue	White	Green	Brown	Red 1,00 mm ²	Black	Black/ Red	Brown/ White	Red 2,50 mm ²	White	-	White



In a coupled trailer with working fog lamp, the fog lamp of the vehicle will be switched off, if applicable.

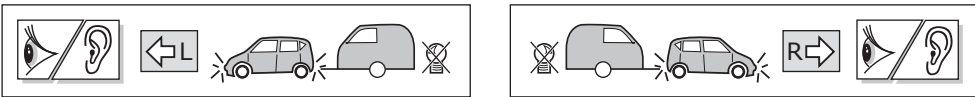

The flashing lights on the trailer are monitored. If one of the indicators of the trailer breaks down, a buzzer will be audible and/or a visual signal will be visible on the dashboard. Check the flashing lights on the trailer.

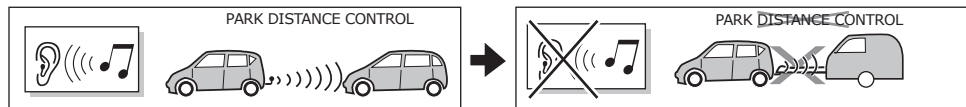

The wiring kit has a possibility to switch off any Park Distance Control in the case of a coupled trailer.

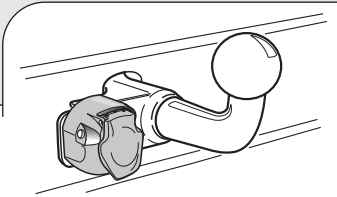

INFO : Ring.

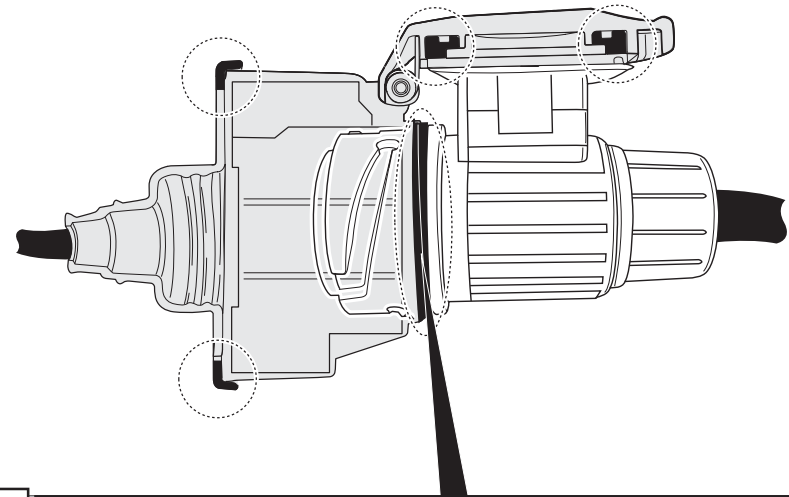
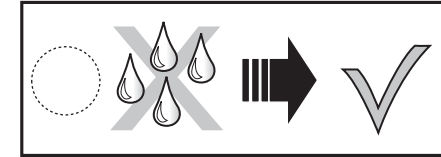
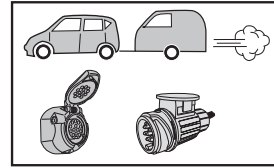

INFO

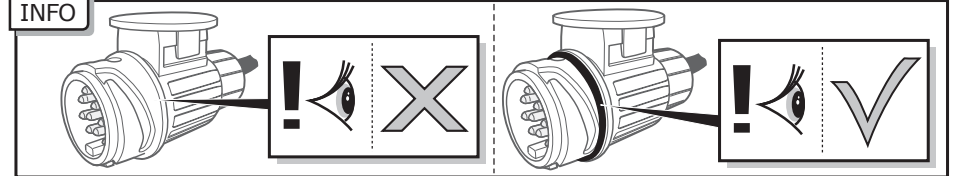

INFO : Adapt.

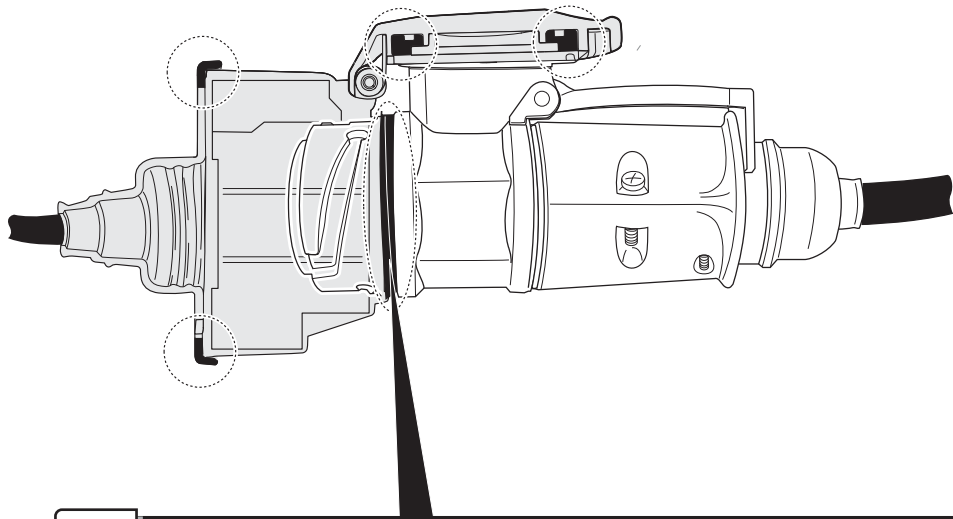
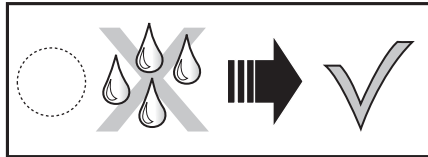
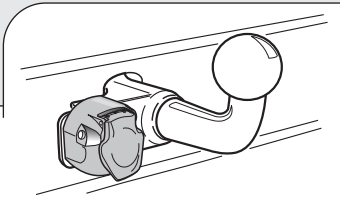
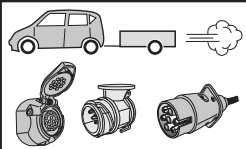

INFO

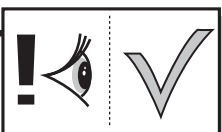
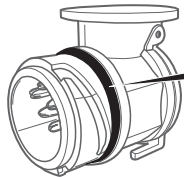
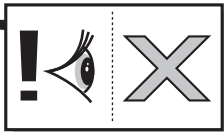
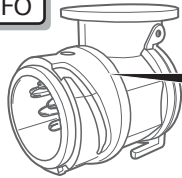

INFO : Storage

