

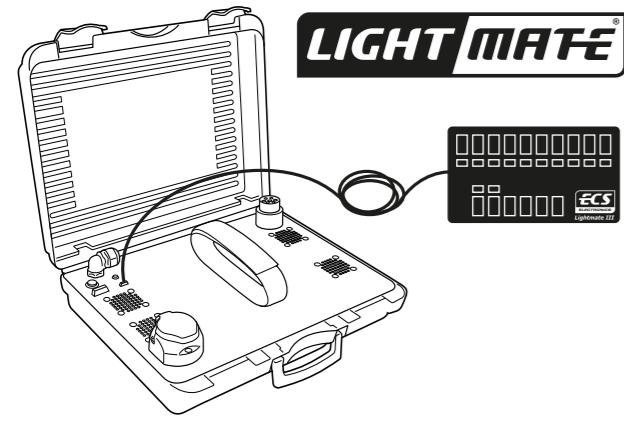

Partnr.: SP-133-ZZU

SELF-SWITCHING POWER FEED EXTENSION KIT FOR 13PIN AND 12S WIRING



www.ecs-electronicsuk.co.uk

Engine off

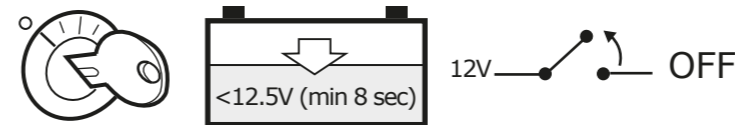

Engine running

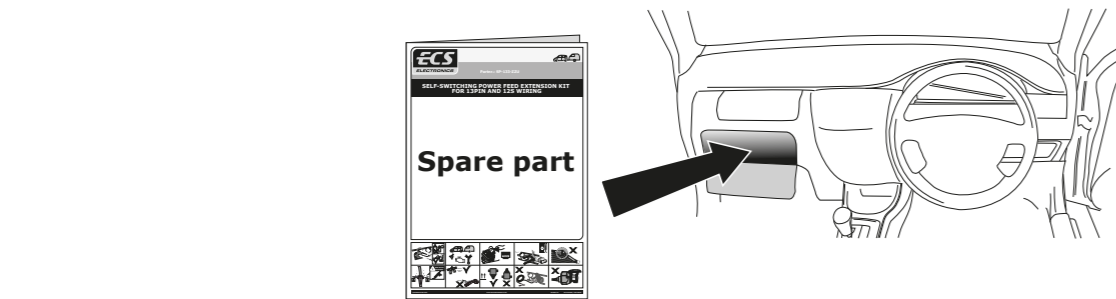
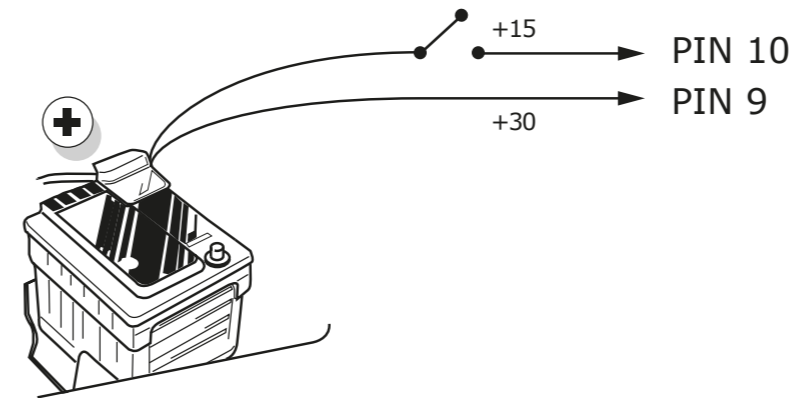
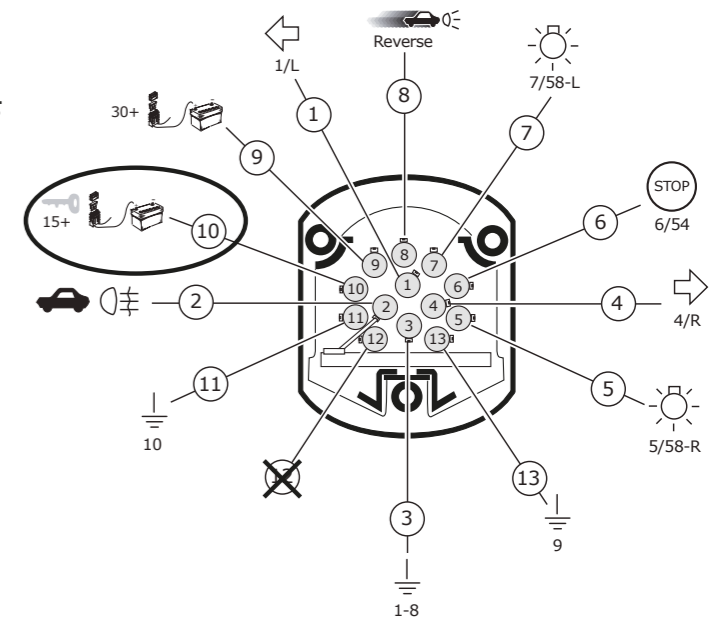
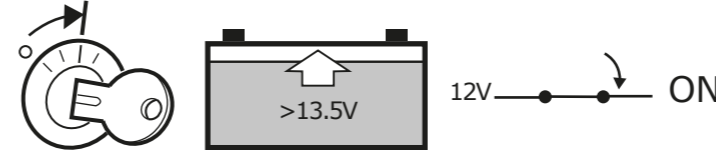

Installation Date:

Technician Name & Signature

Stamp:

.....

.....



We would expressly point out that assembly not carried out properly by a competent installer will result in cancellation of any right to damage compensation, in particular those arising by virtue of the product liability act. Contents of these kits and their fitting manuals are subject to alteration without notice, please ensure that these instructions are read and fully understood before commencing installation. Do not overload circuits; the maximum loads per connection are detailed in this manual. The following information must be reviewed before beginning the assembly: The installation instructions are to be thoroughly read. The installation should be carried out by qualified personnel with the relevant technical knowledge. The vehicle manufacturers' current technical notices and information on retrofitting must be followed. The removal and replacement instructions found in the current repair manuals must be followed. It must be ensured that the vehicle is technically suitable for the installation of a trailer hitch. The vehicle's fault memory must be read out. In the event of functional problems, troubleshooting must be limited to about 0.5 hours, contact the technical support.

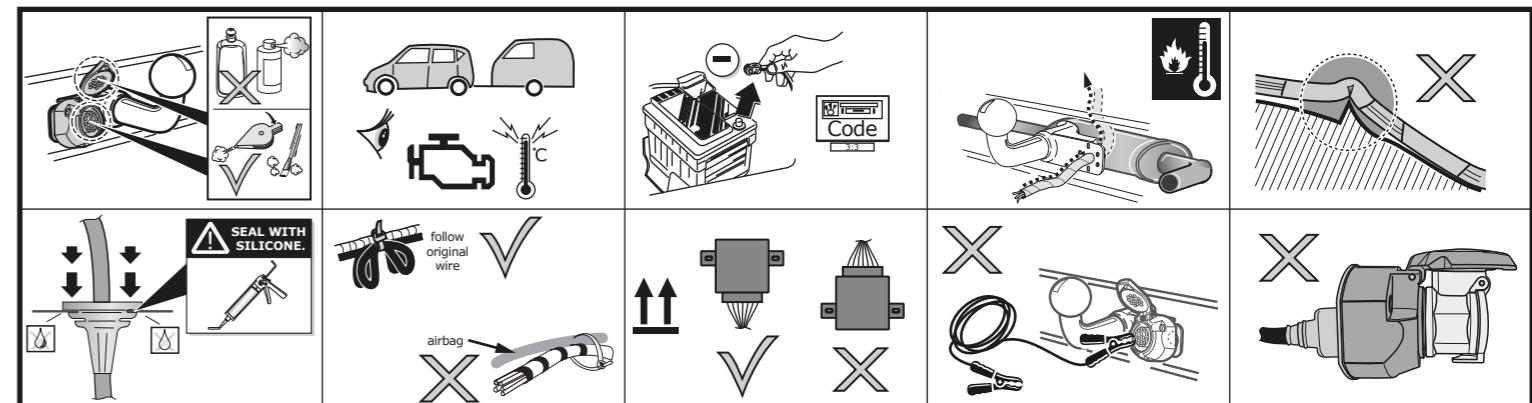

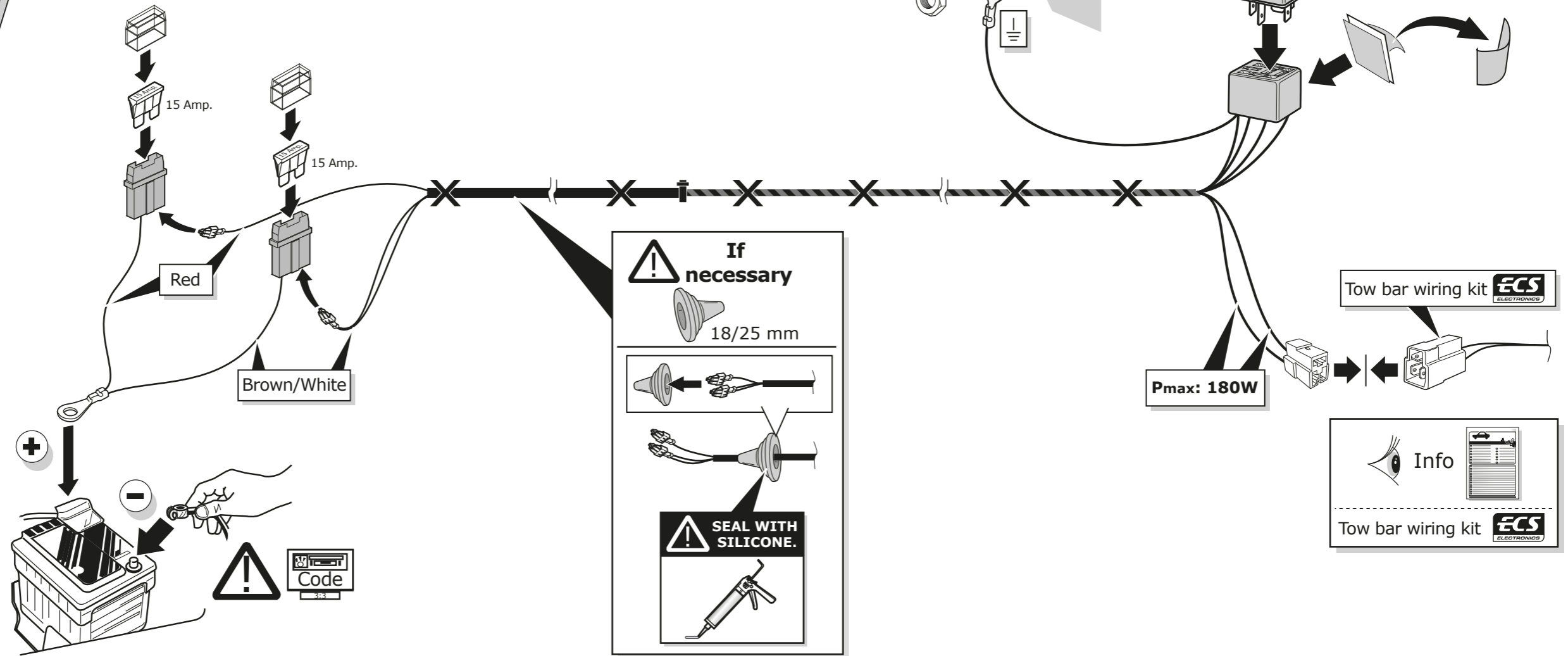
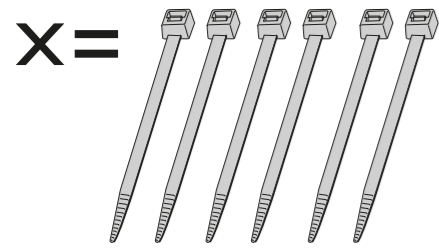

! TEST ALL CIRCUIT FUNCTIONS !

TEST 1

Engine off

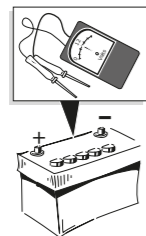
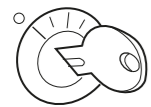

<math>< 12.5 V</math>

LIGHTMATE 3

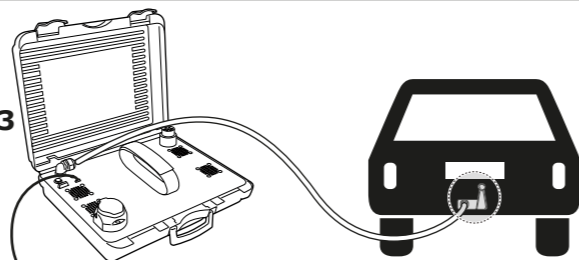

+30 **+15**

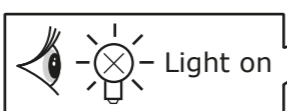

Light on



Light off

1

2

3

TEST 2

Engine running

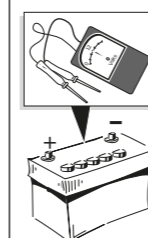

>math>> 13.5 V</math>

LIGHTMATE 3

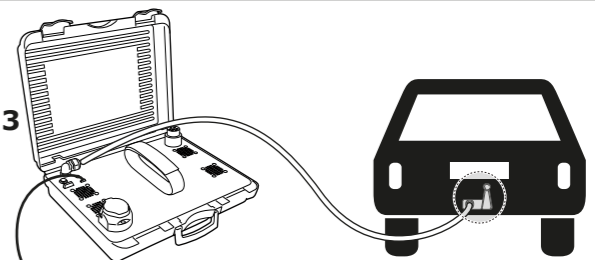

+30 **+15**

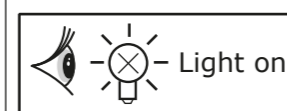

Light on

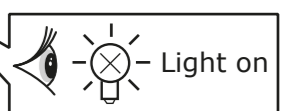

Light on

1

2

3