

SSANGYONG/KGM

Korando C300	09/2019 >>	Torres J100	08/2023 >>
Korando e-Motion	01/2022 >>	Torres EVX	02/2024 >>
Tivoli X150	09/2019 >>	Torres HEV	09/2025 >>
Tivoli Grand	08/2021 >>	Actyon (J120)	01/2025 >>

Part No: SY-022-07U

Electric wiring kit for towbars / 7-pin / 12N / 12 Volt / ISO 1724 Fitting instructions

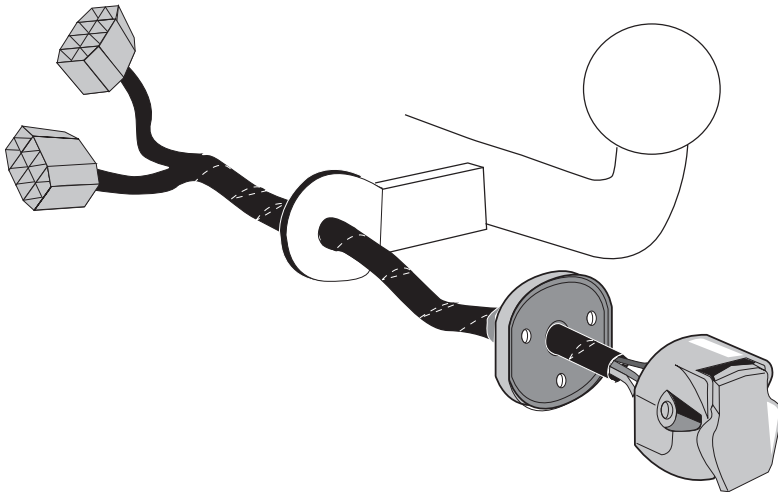

IMPORTANT!

This electric kit has to be installed by a professional workshop or a suitable qualified person.

The installation instructions must have been read and fully understood before the start of any installation. Please contact your wiring kit provider or the hotline shown in the footer should you need assistance!

Make sure the vehicle is approved/homologated by the manufacturer to tow a trailer!

Also please check that there is a definite compatibility between this vehicle and the electric kit!

Following the installation of the electric kit, the fitting instructions should be kept together with the vehicle service document and vehicle handbook. The fitting instructions contain important information relating to the use and function of the towing kit as well as for any diagnostic or activation process, that might have to be repeated in the future (e.g. after the performance of a vehicle software update).

All warranty claims will be forfeited if the electric kit or components contained therein are used incorrectly or modified. If a towing socket adaptor has been used to connect to the trailer or bike rack, this must be removed from the trailer socket once the trailer or bike rack has been disconnected.

If the trailer or bike rack is not equipped with a rear fog lamp, depending on the towing vehicle type, the correct function of the towing kit cannot be guaranteed. In such cases, a rear fog lamp should be retro fitted.

This towing electric kit will not be covered under warranty if any technical or electrical modifications or software updates have been performed by the vehicle manufacturer after the initial commissioning of the kit. That applies especially to modifications or updates which may cause malfunctions in the trailer socket or any other part of the trailer electrical equipment!

Depending on the type of trailer module used in this electric kit, diagnostic interrogation with the vehicle's electrical system may be limited or will not function. The error memory inside the trailer module may not be able to be accessed by vehicle manufacturers diagnostic system.

Error logs relating to the trailer electrical equipment, that may be generated in the vehicle manufacturers diagnostic system as a result of a test procedure, may be due to the incorrect installation of the towing electric kit or the false activation of the trailer module.

We always recommend whenever possible, the following troubleshooting process:

→ An analysis of the vehicle's error memory and possibly clearing of all faults before the start of the installation!

→ Try disconnecting the trailer module from the towing harness and re-start the fault clearing process!

→ If in doubt, limit the time for troubleshooting to a max of 0,5 hours and call our Technical Support Team!

Please follow our instructions carefully and always test the towing electrics using a true lighting board or a specifically designed bulb tester. If an LED tester is used, ensure it is equipped with correct load resistors or malfunctions will occur!

This instruction is subject to changes and we reserve the right to make changes to design, colour etc.

All of the data and illustrations may not be an exact representation but the text contained in this instruction must be observed!

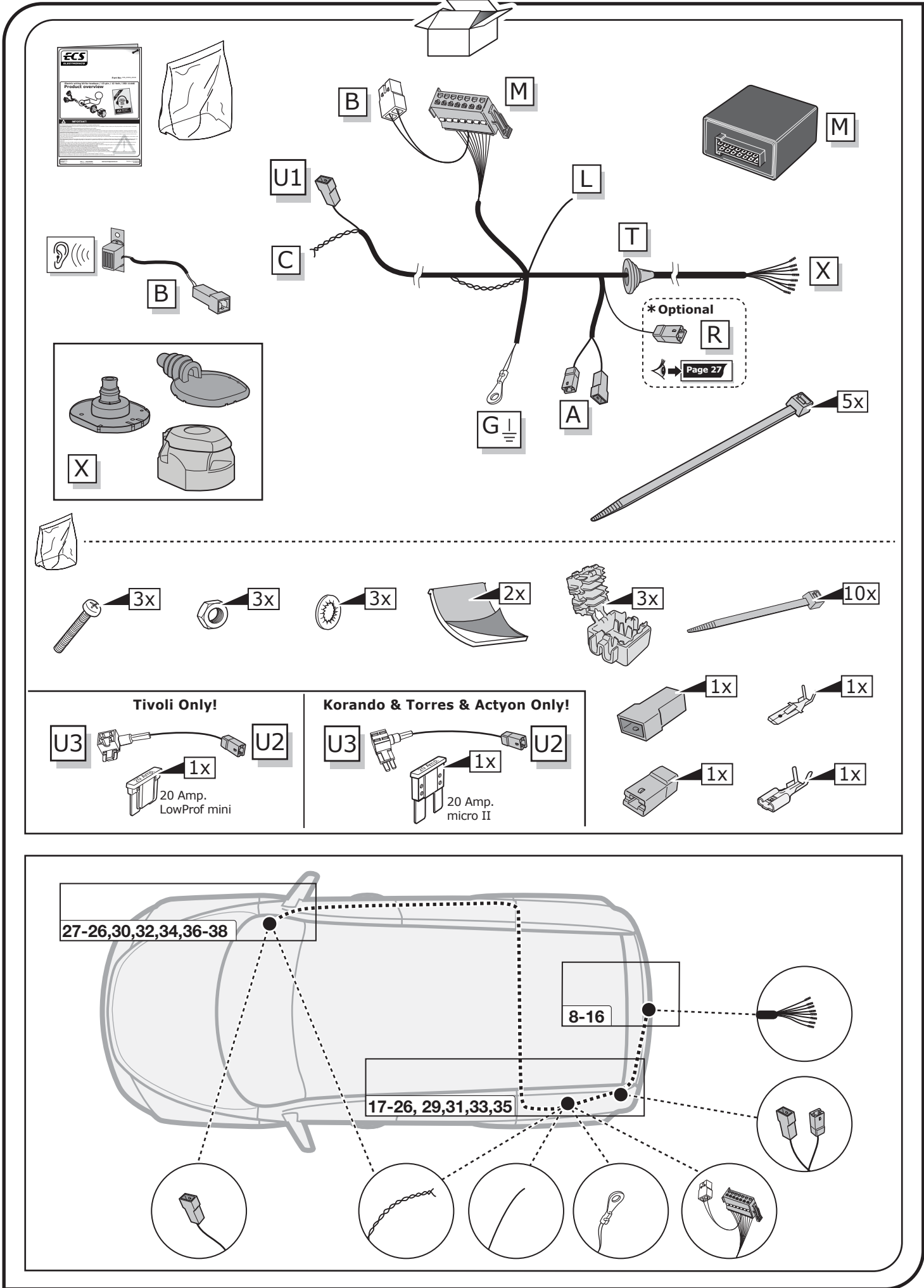

SYMBOL EXPLANATION

58L	Left taillight (58-L)
58R	Right taillight (58-R)
54	Stop light (54) / high mounted, third stop light (54)
	Turn signal indicator left
	Turn signal indicator right
	Rear fog light(s)
	Reversing lights(s)
+30	Permanent power supply / 13pin socket, chamber 9
+15	Charging wire for trailer battery / 13pin socket, chamber 10
	Trailer / Trailer recognition
+30	Permanent current power supply
+15	Voltage after ignition

	Ground or Earth (31)
	Ground connection battery terminal lug
	Positive connection battery terminal lug
	Fuse / fuse capacity 20 Amp
	Loudspeaker / buzzer
	Park distance control
	Switch / source of function
	Connect together
	Disconnect
	PDC cut off
	Look carefully at selected area
	Present / Occupied / OK

	Not present / Not occupied / not OK
	Left
	Right
	Acoustic indication
	Attention / important advice
	Reusable
	Trash bin
	Use tape
OPTION	Option
INFO	Information
	Measure the voltage
NO NC COMMON	Normally open Normally close Common

TOOLS

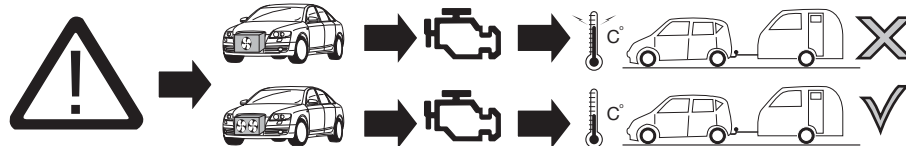
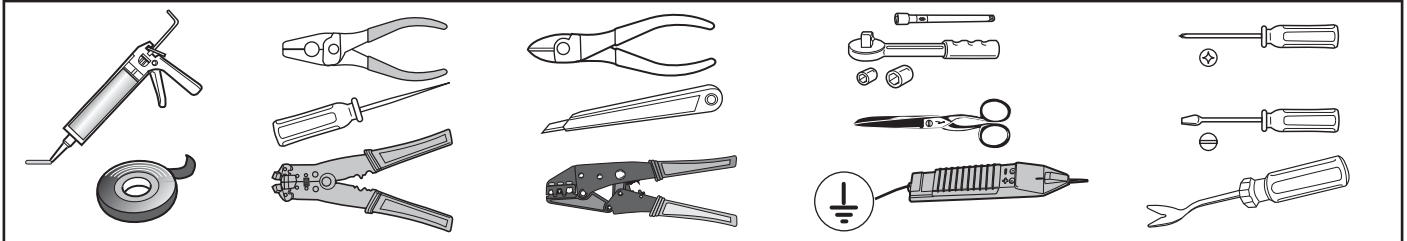

ATTENTION! The vehicle's cooling capacity may have to be increased when retrofitting a trailer coupling! You must observe the manufacturer's instructions!!

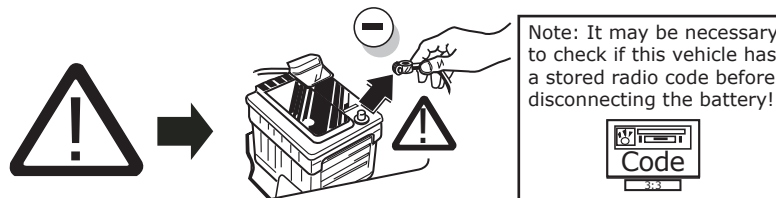

ATTENTION! In order to avoid mal-functions and damage to the vehicle's electrical system the earth terminal **must be disconnected** from the vehicle's battery **before starting work!**

Both the trailer module and the vehicle's control unit for the electrical system can be damaged during work on the data bus connections if the battery is not disconnected!

Please pay attention to the manufacturer's instructions when disconnecting and reconnecting the vehicle's battery!

1

Korando

Tivoli X150

Torres

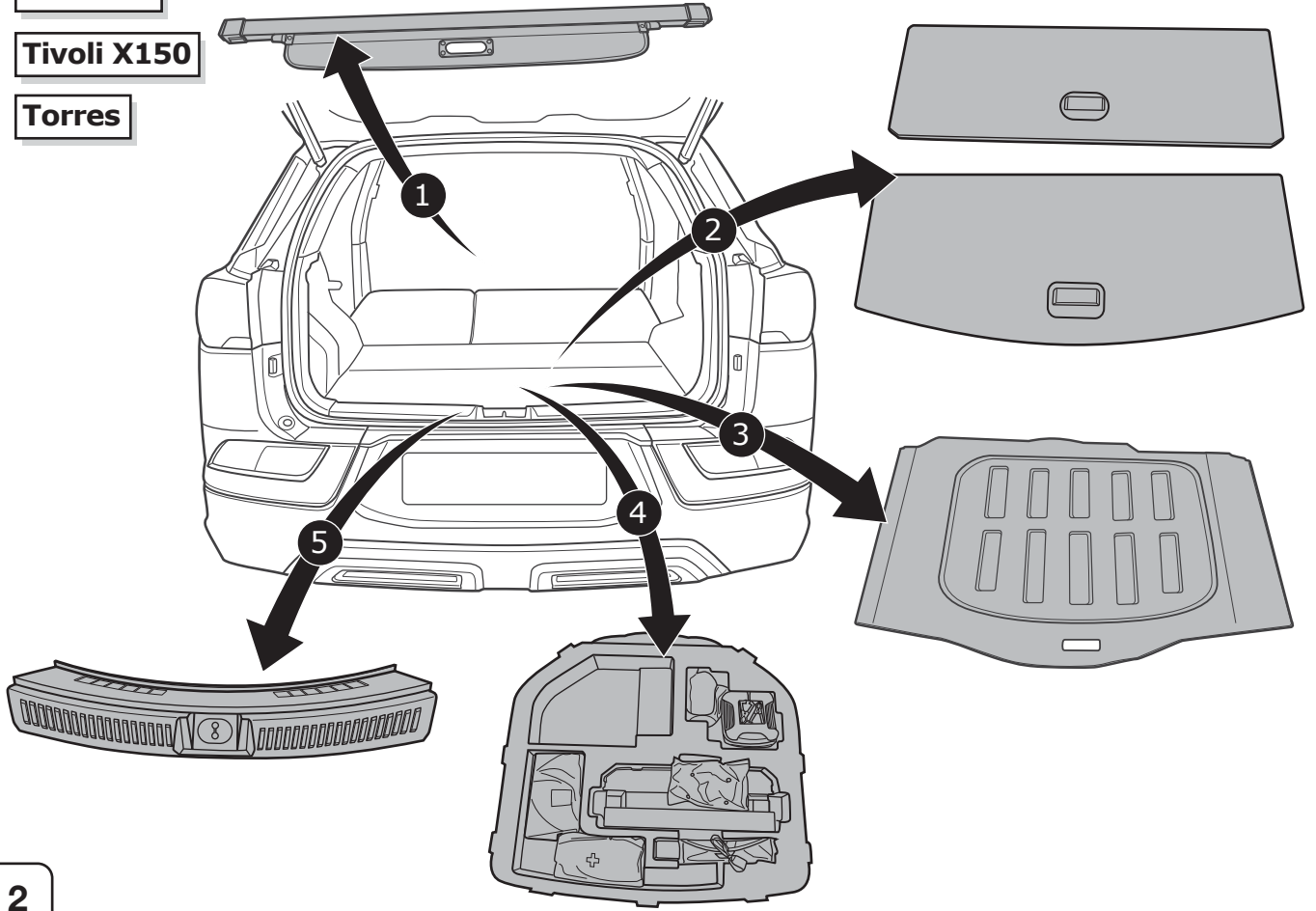

2

Tivoli Grand

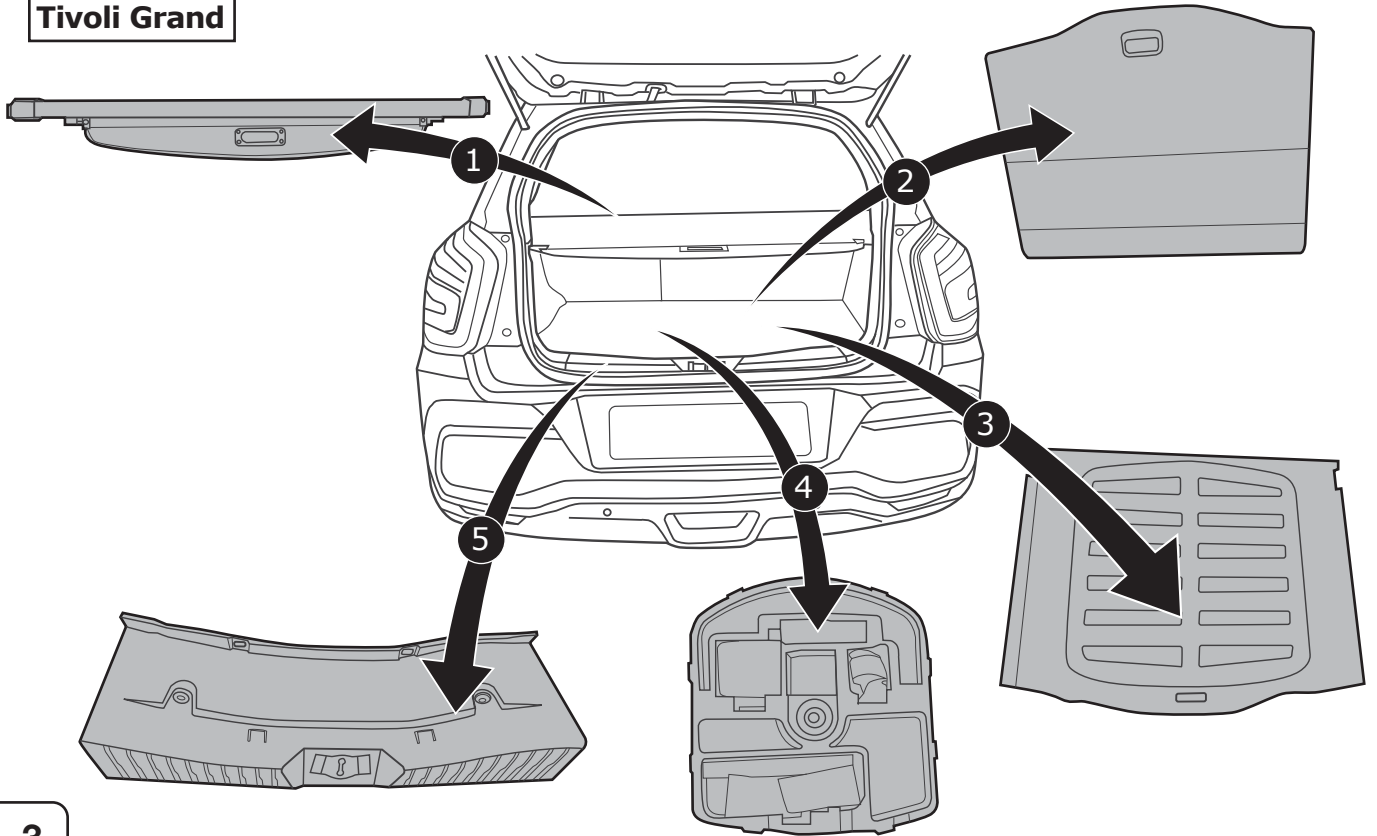

3

Korando

Tivoli X150

Tivoli Grand

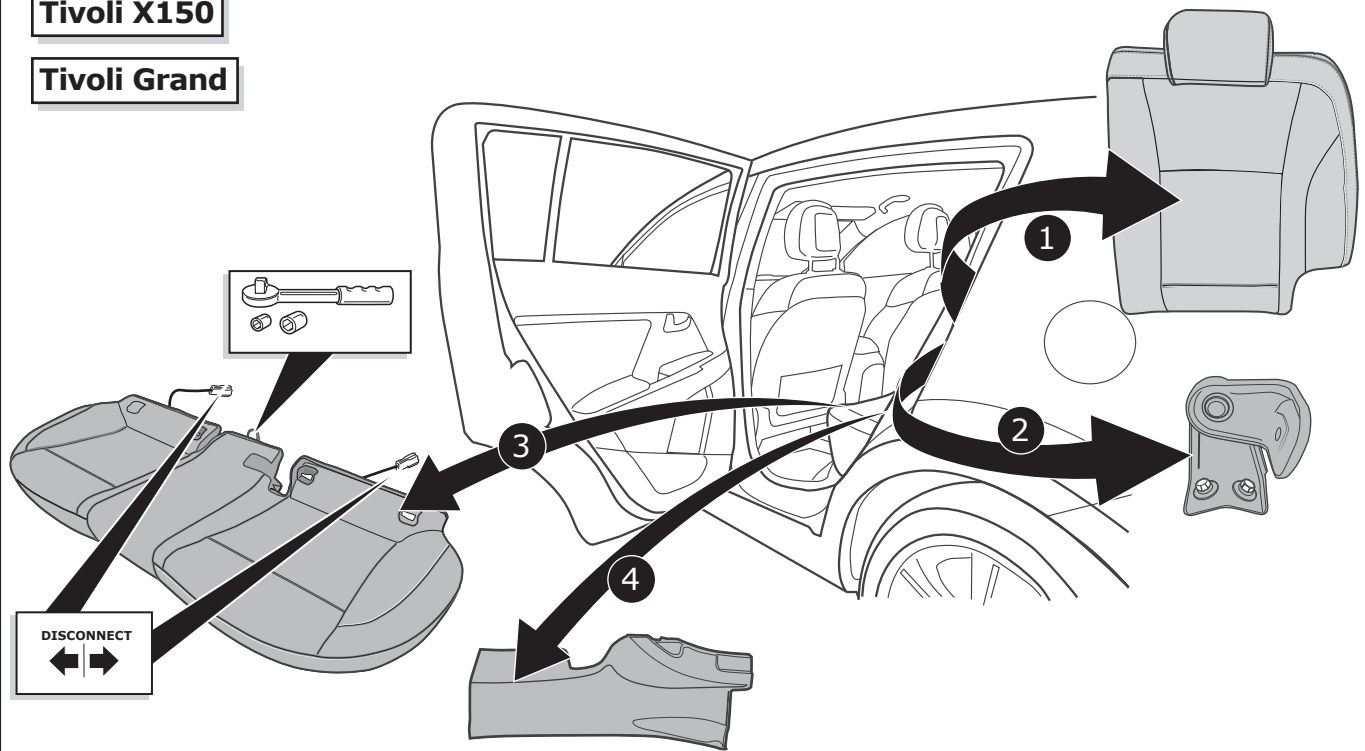

4

Korando

Tivoli X150

Torres

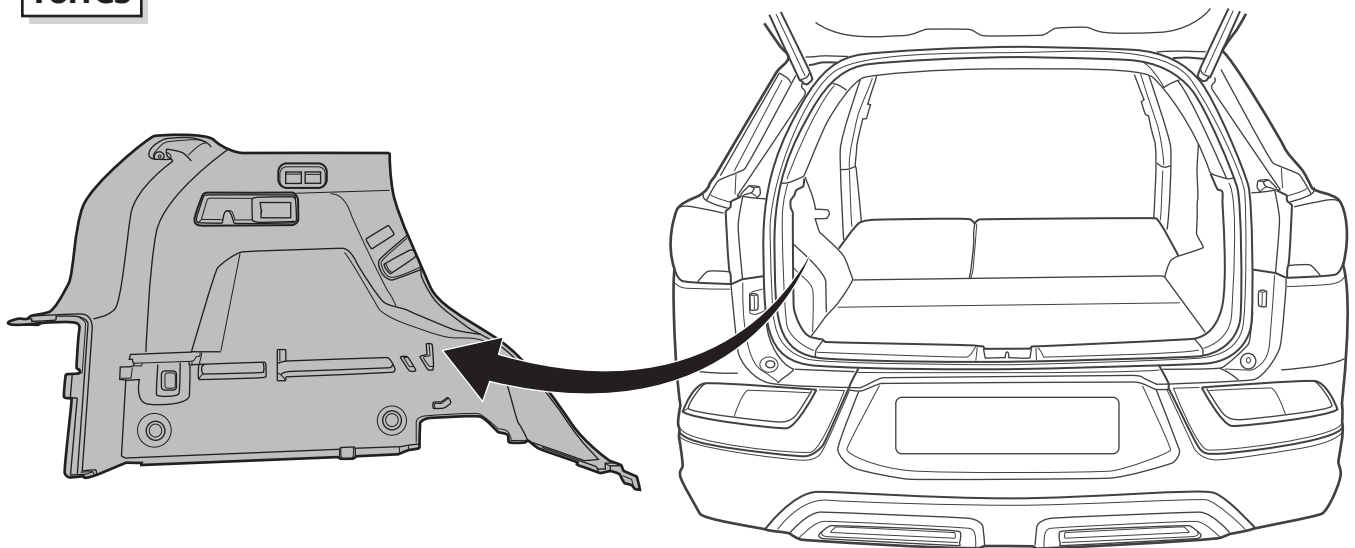

5

Tivoli Grand

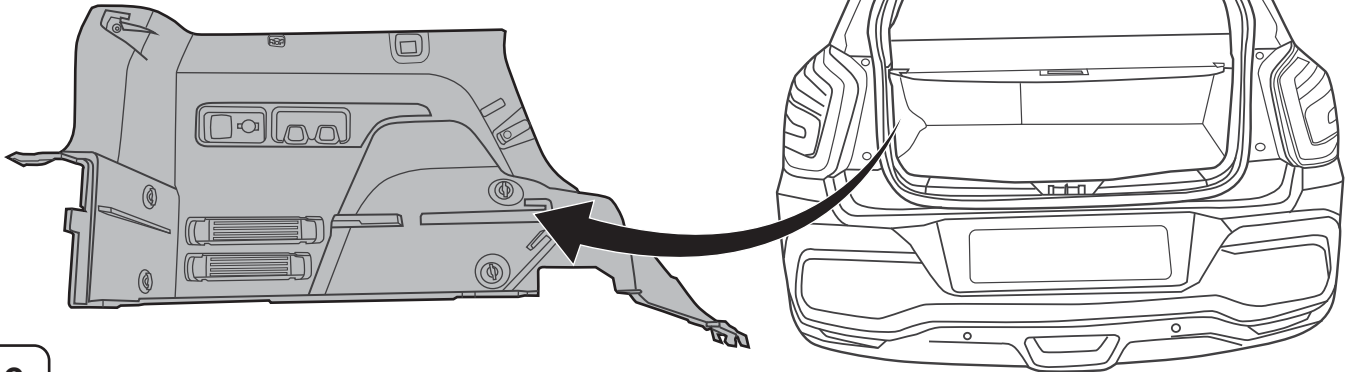

6

Actyon

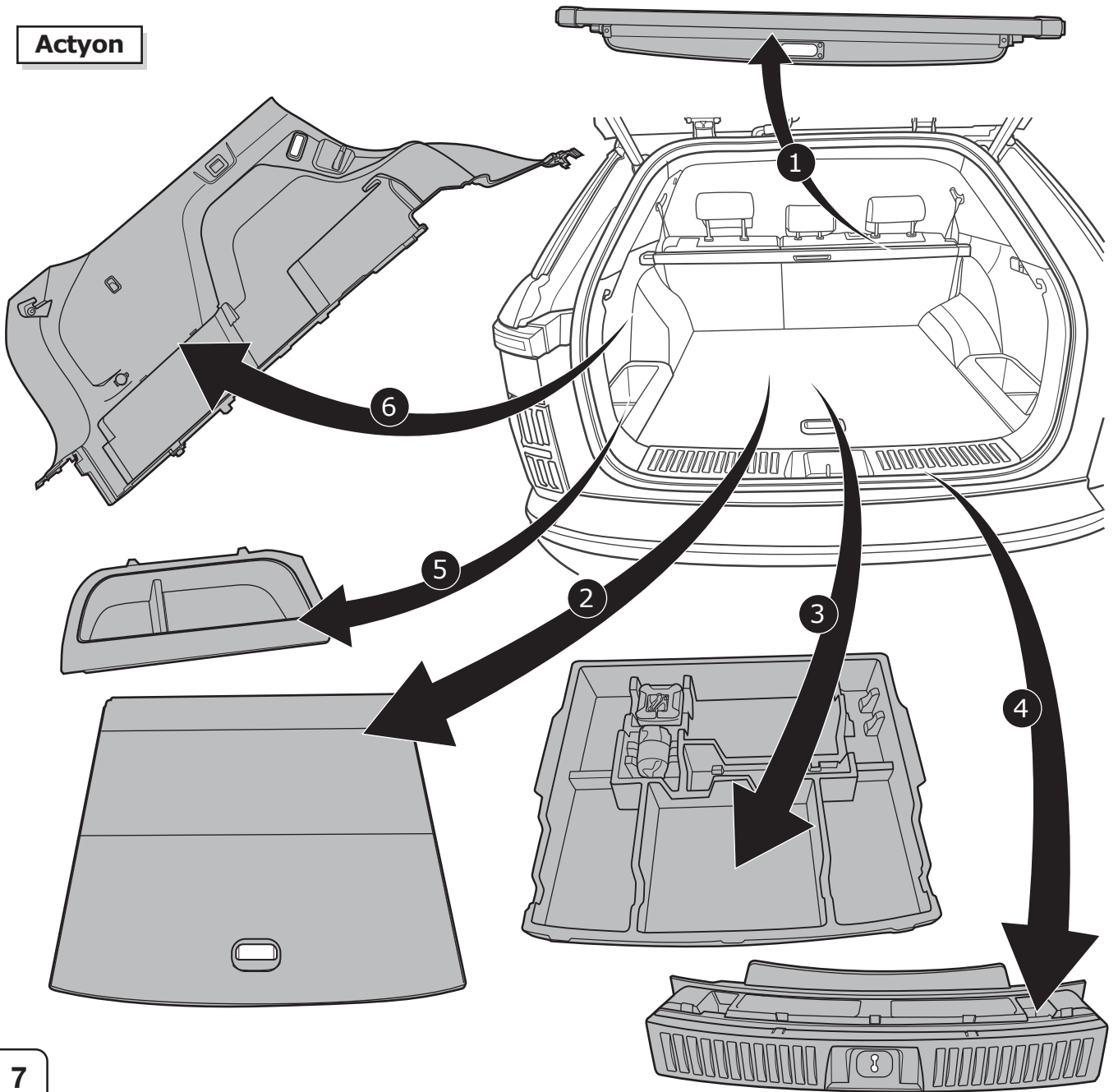

7

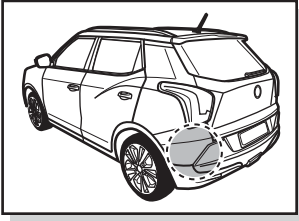

Korando

Tivoli X150

Option 1

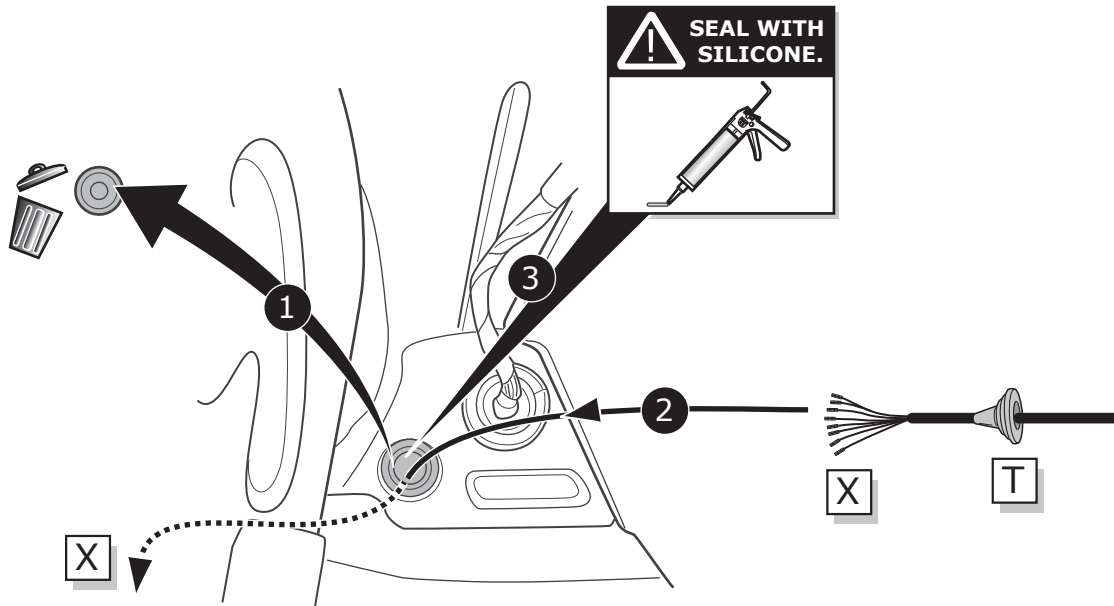
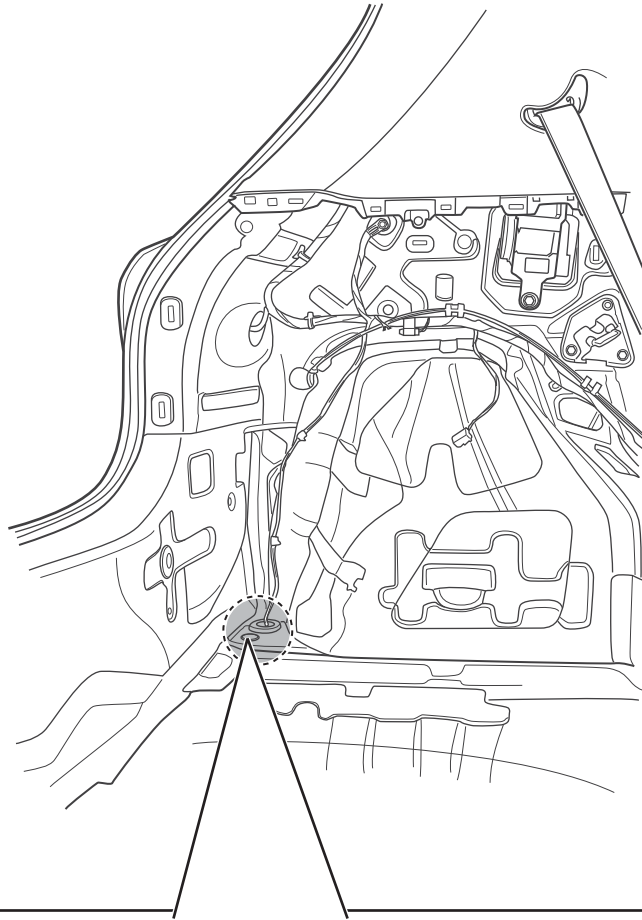

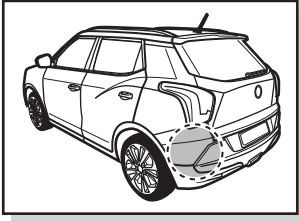

Korando

Tivoli X150

Option 2

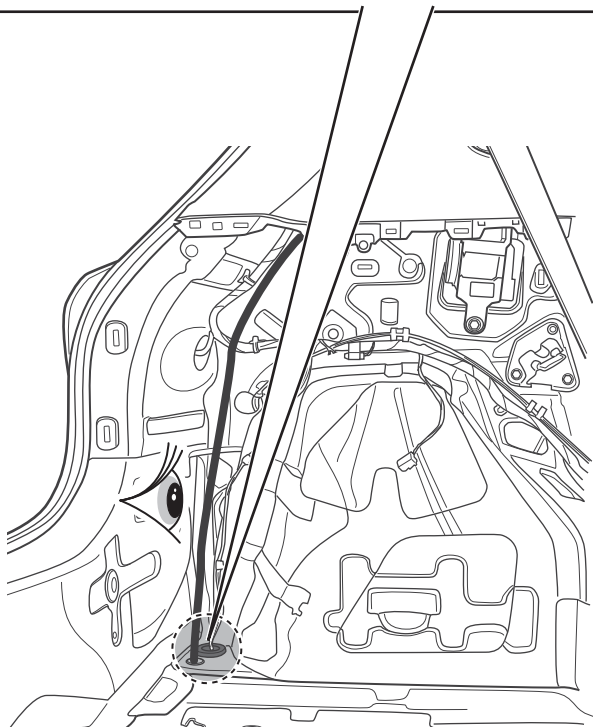
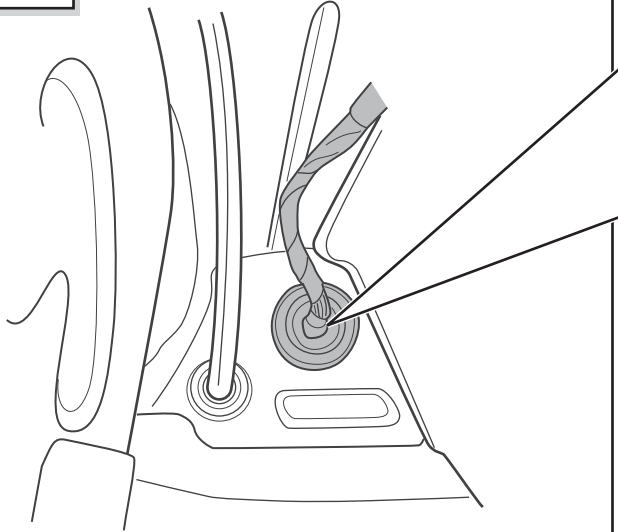

9

1

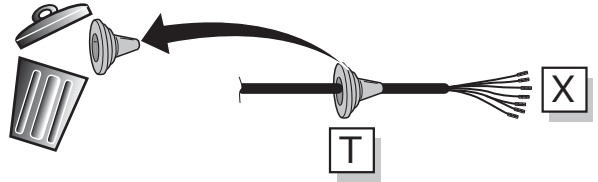

2

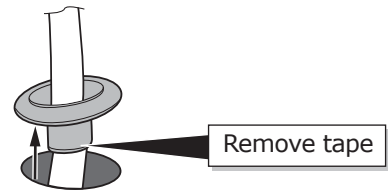

3

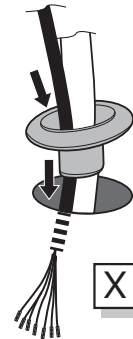

4



5



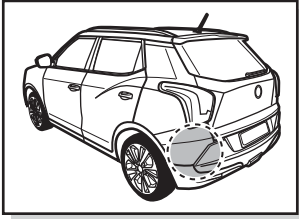

Tivoli Grand

Torres

Actyon

Option 1

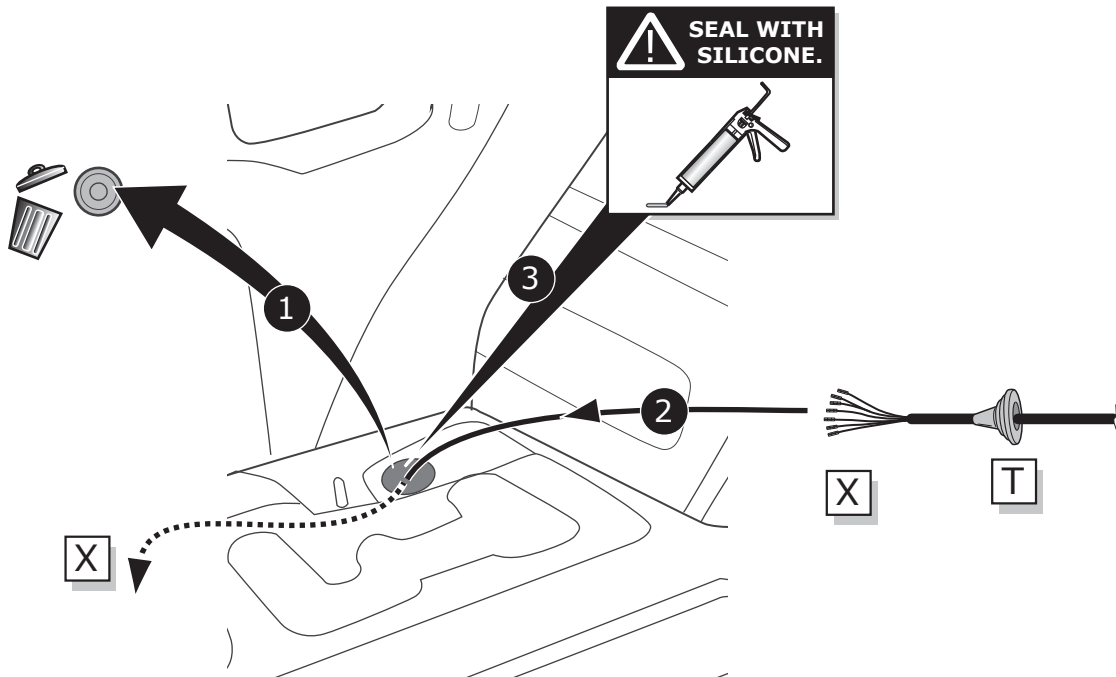
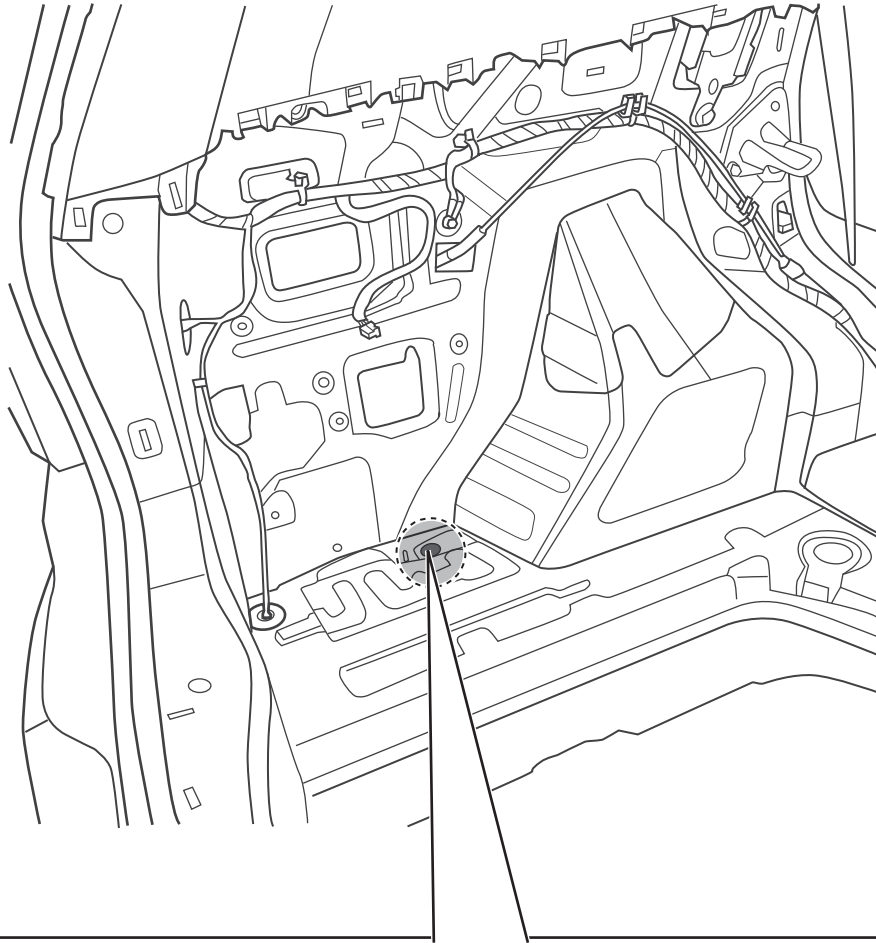

10

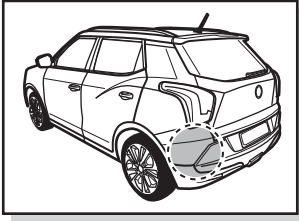

Tivoli Grand

Torres

Actyon

Option 2

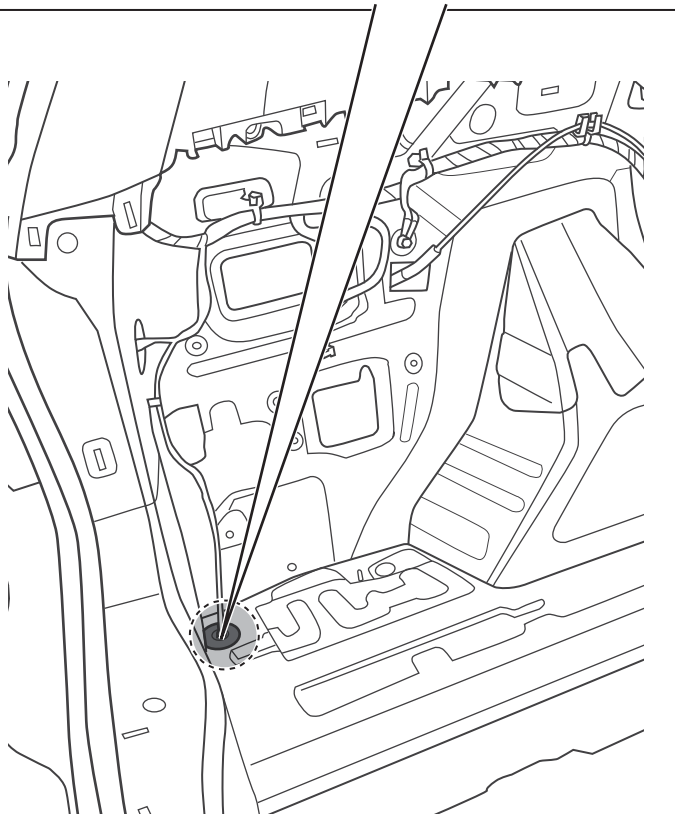
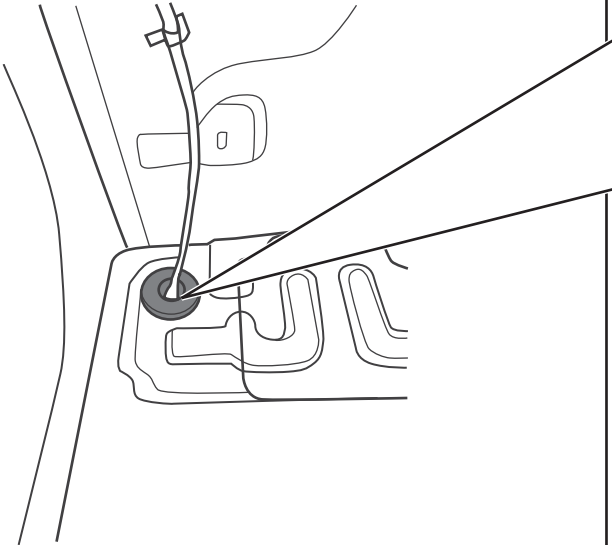

11

1

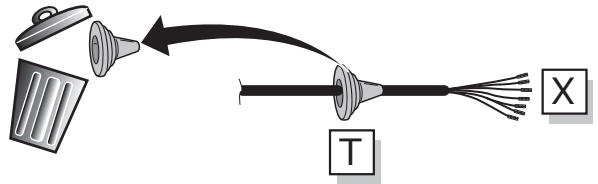

2

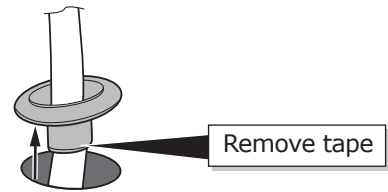

3

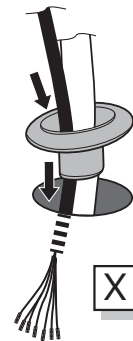

4



5



Option 1

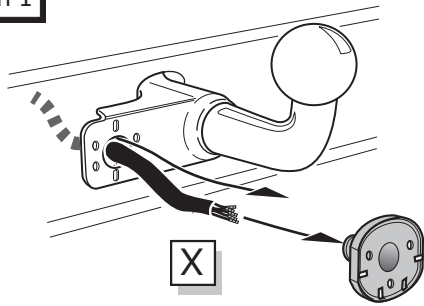

12

Option 2

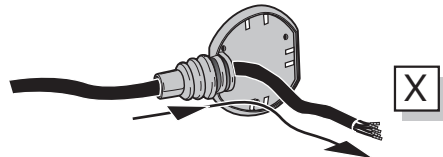

Option 3



SOCKET CONNECTION



Page 31

13

Option 1

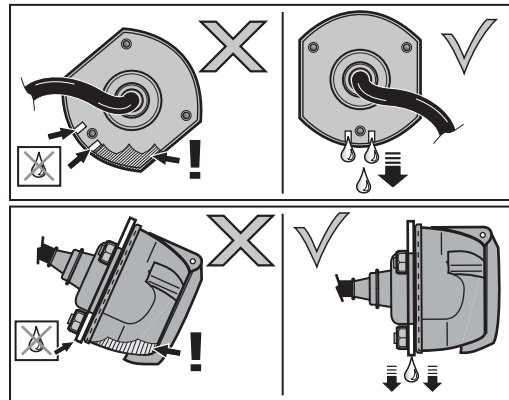
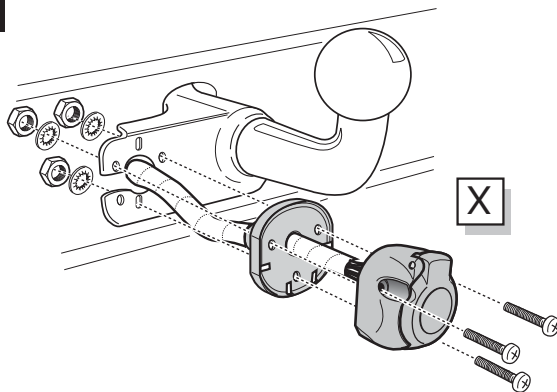

14

Option 2

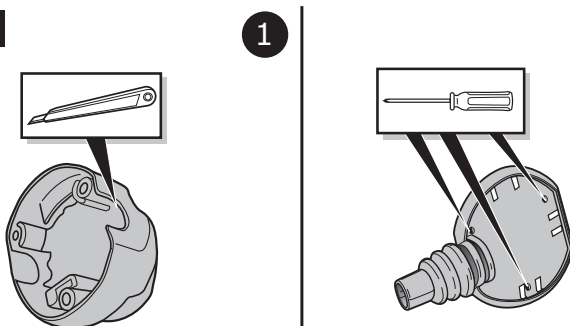

15

Option 3

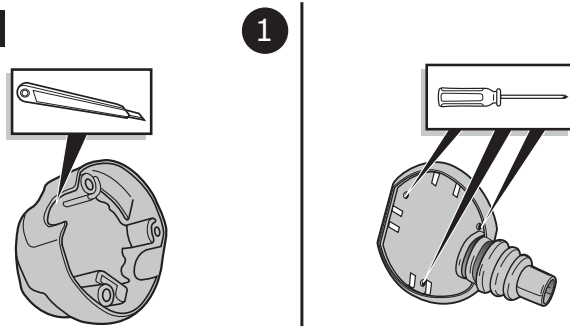

16

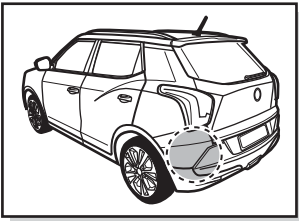

Korando

Tivoli X150

1

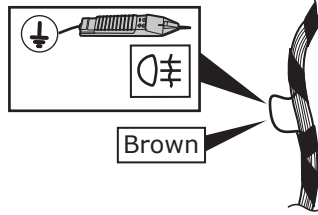

2

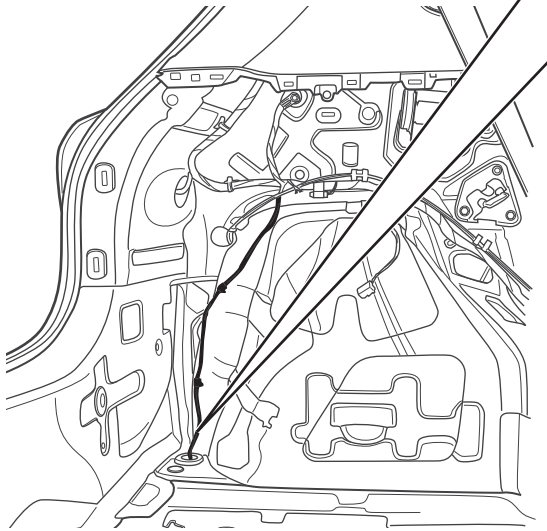
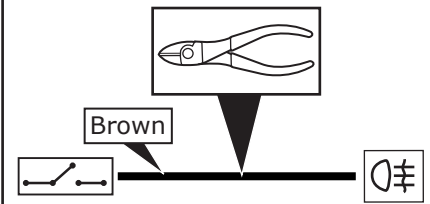

17

3

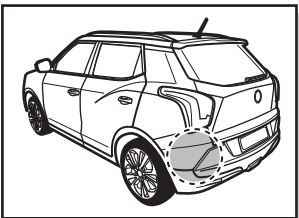
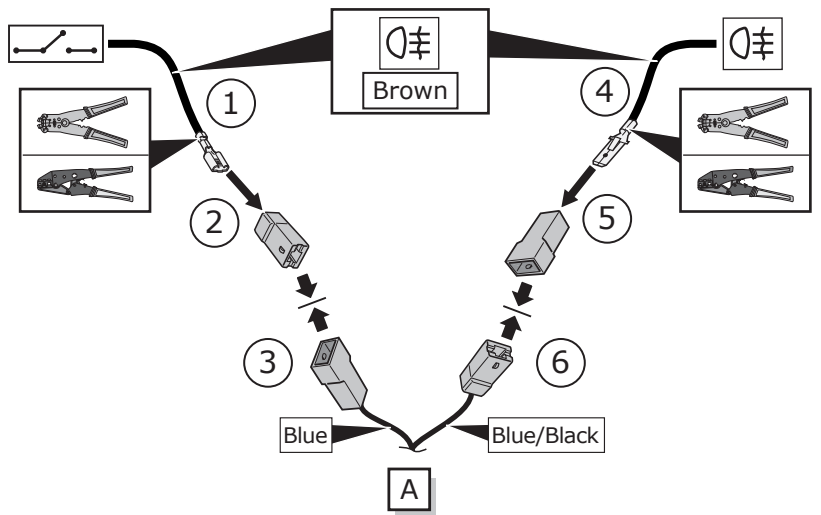

Tivoli Grand

Actyon

Torres

1

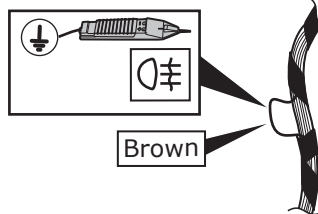

2

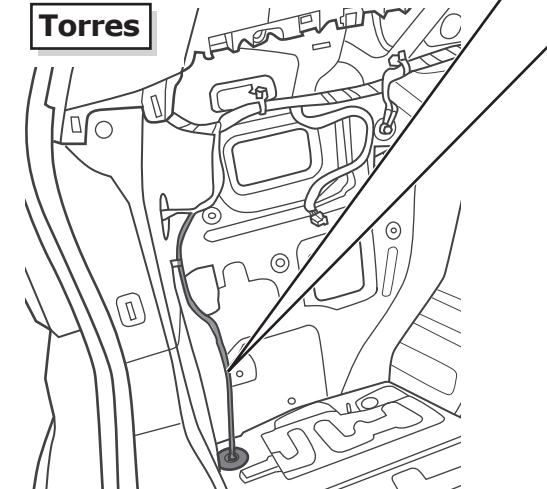
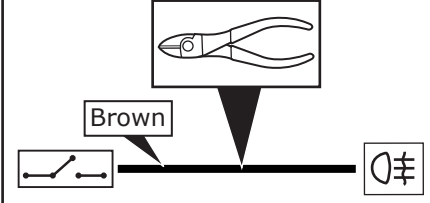

18

3

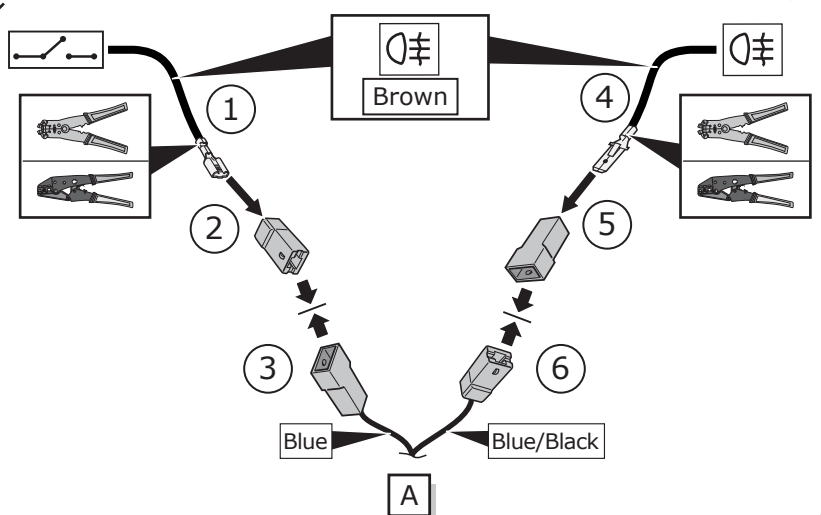

1

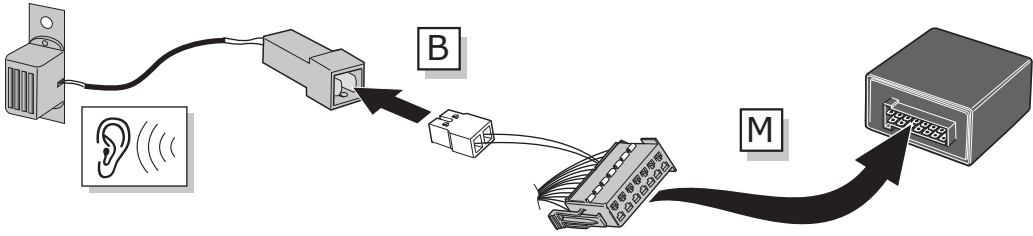

2

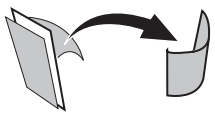

3

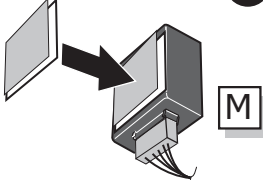

4

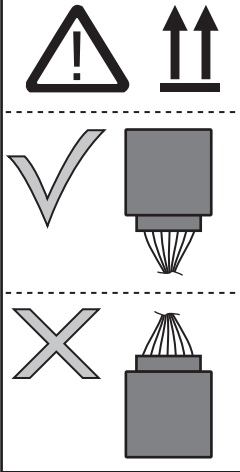
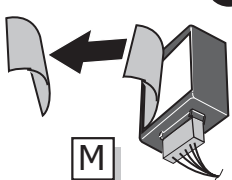

5

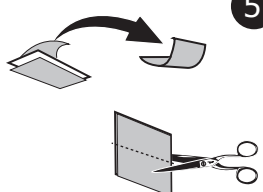

6

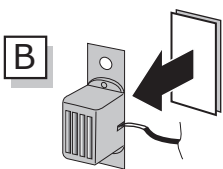

7

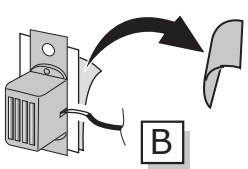

19

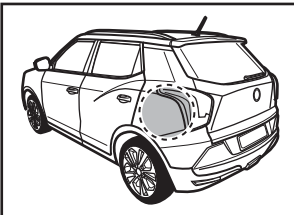

Korando

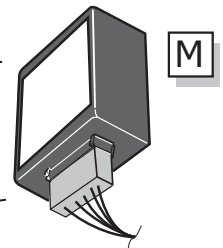
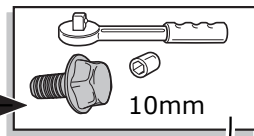
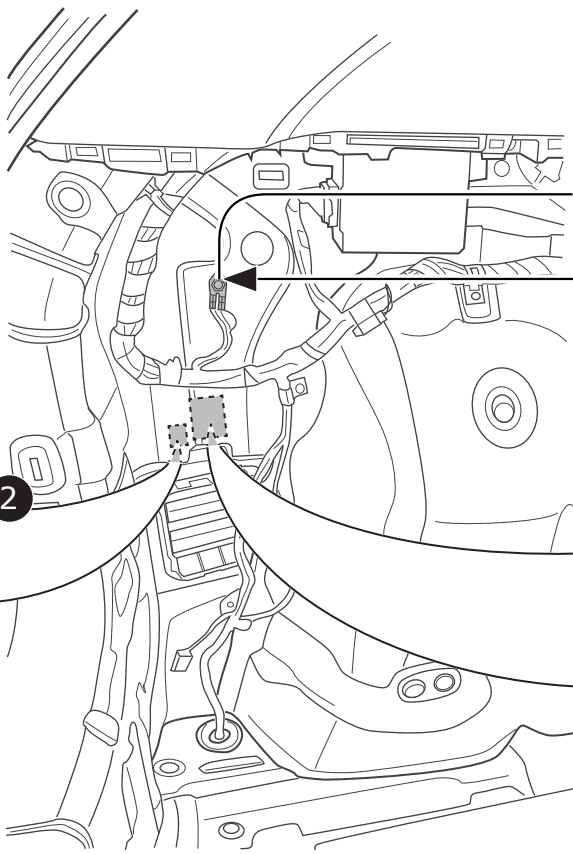

20

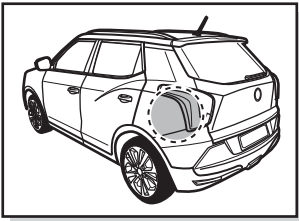

Tivoli X150

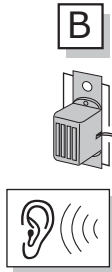

2

1

3

4

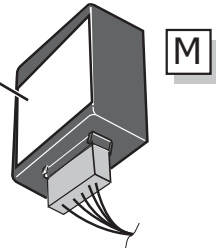
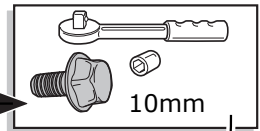

21

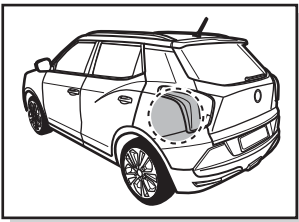

Tivoli Grand

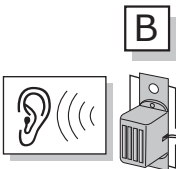

2

1

3

4

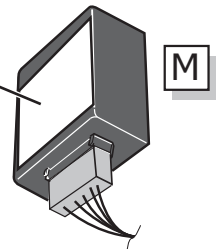
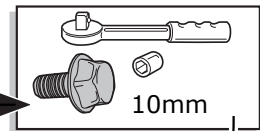

22

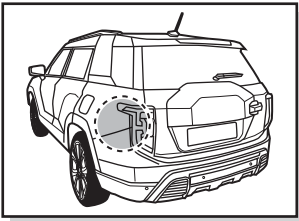

Torres

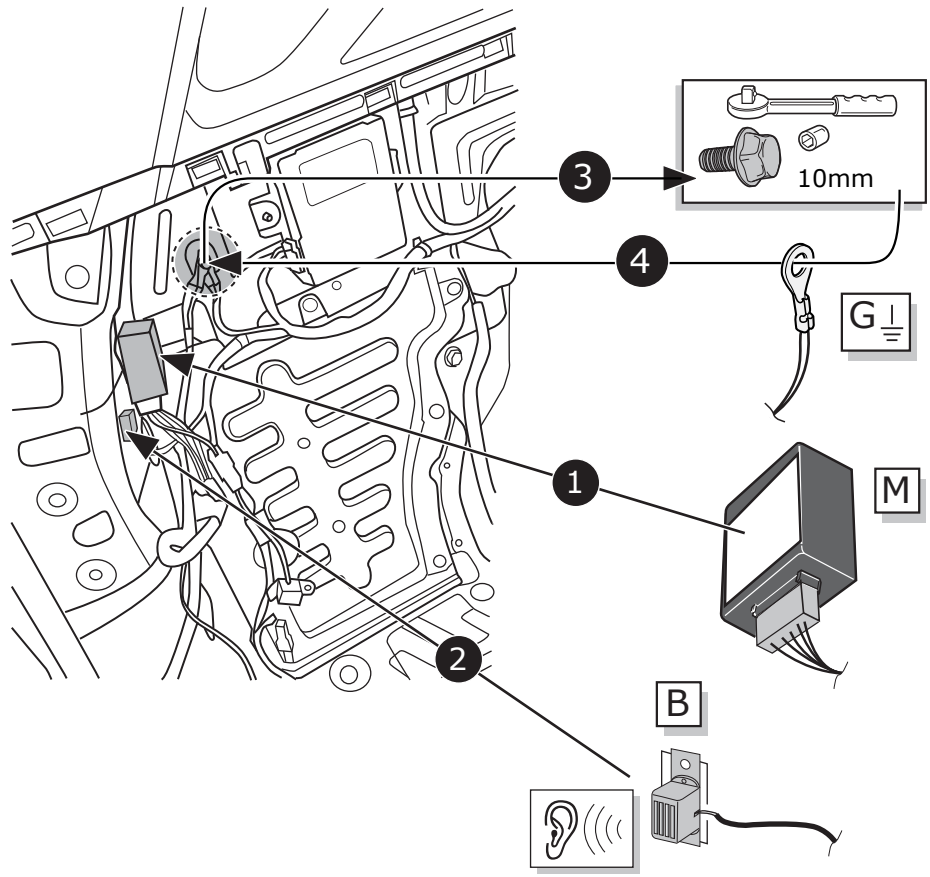

23

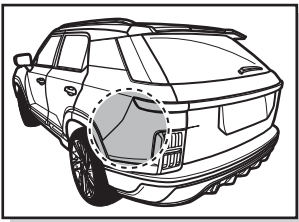

Actyon

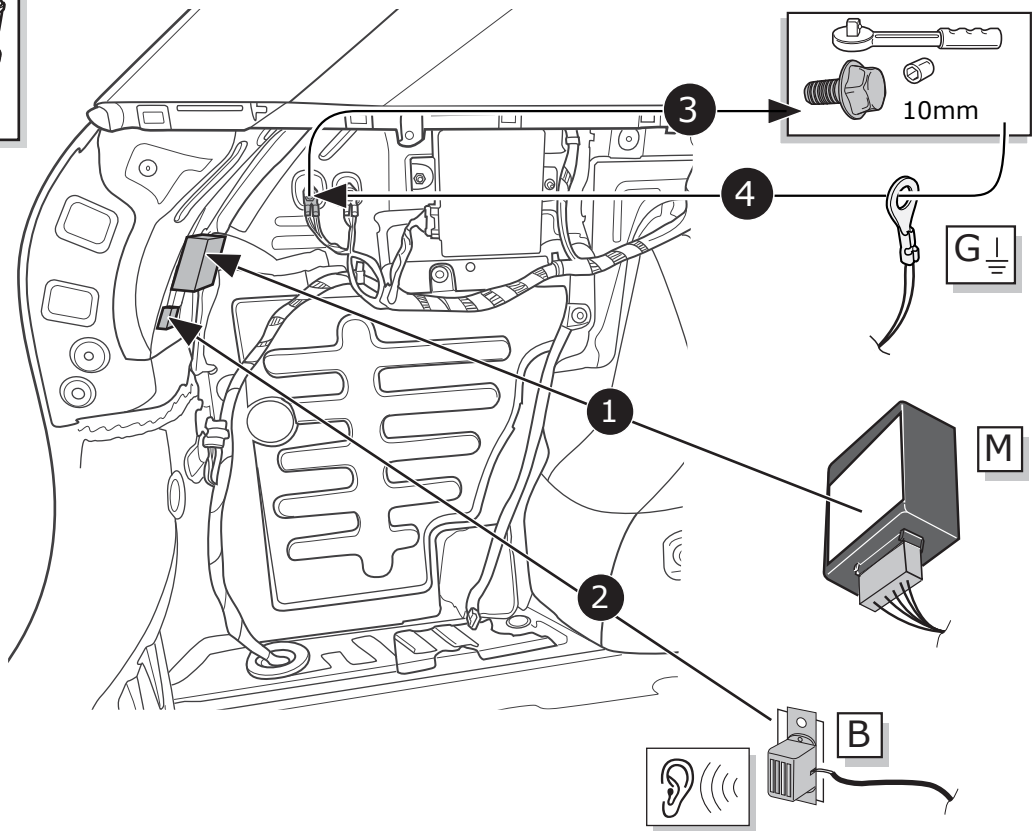

24

Korando

Tivoli X150

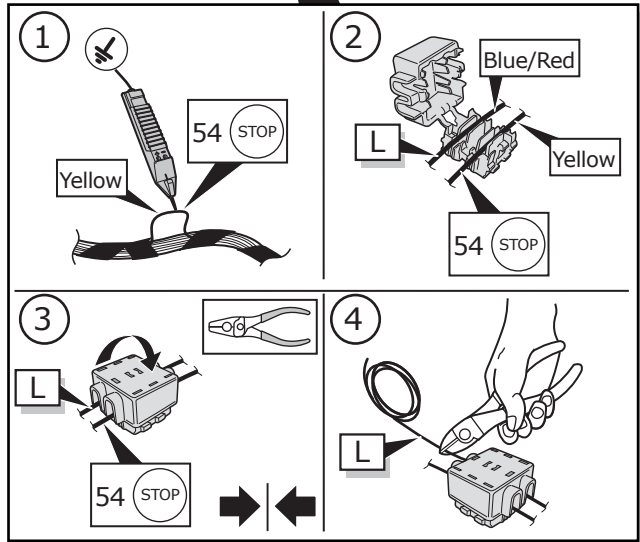
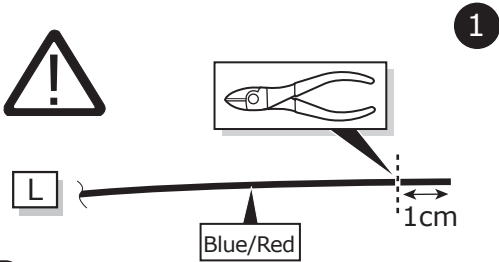
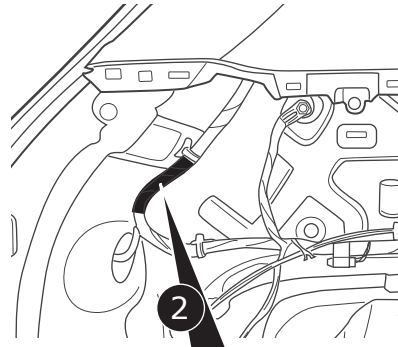
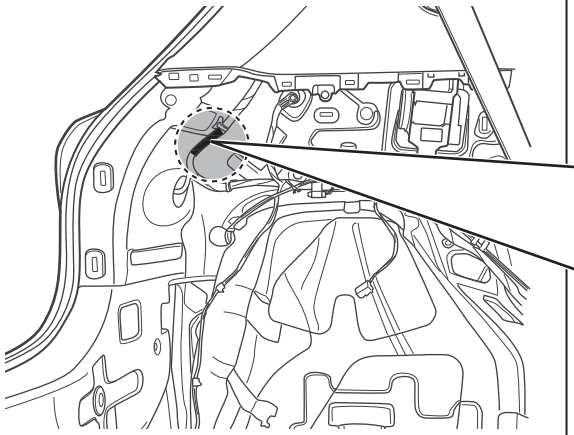

25

Tivoli Grand

Torres

Actyon

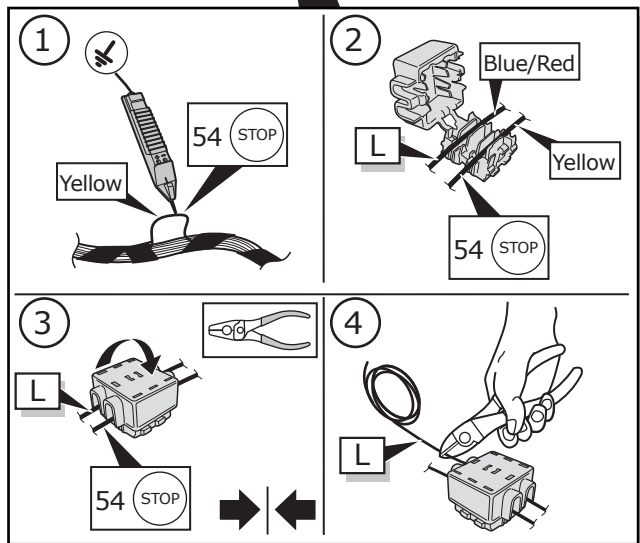
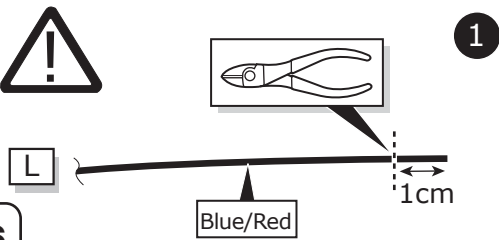
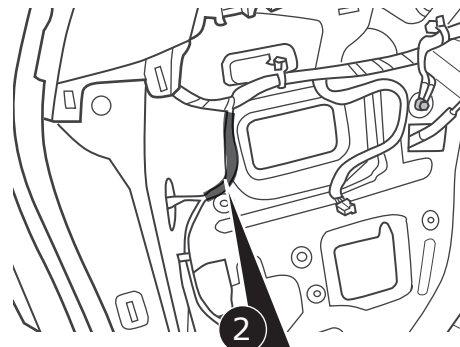
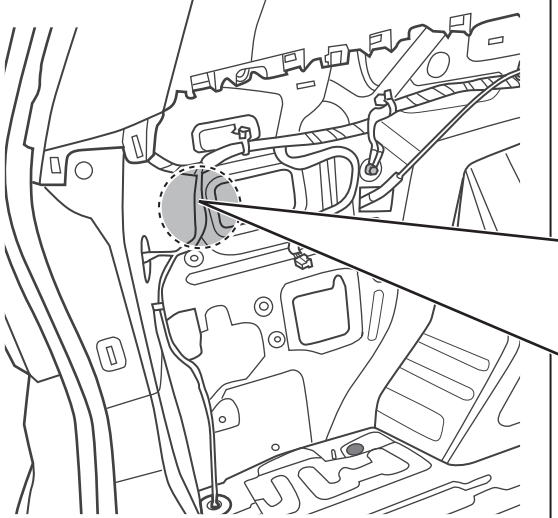

26

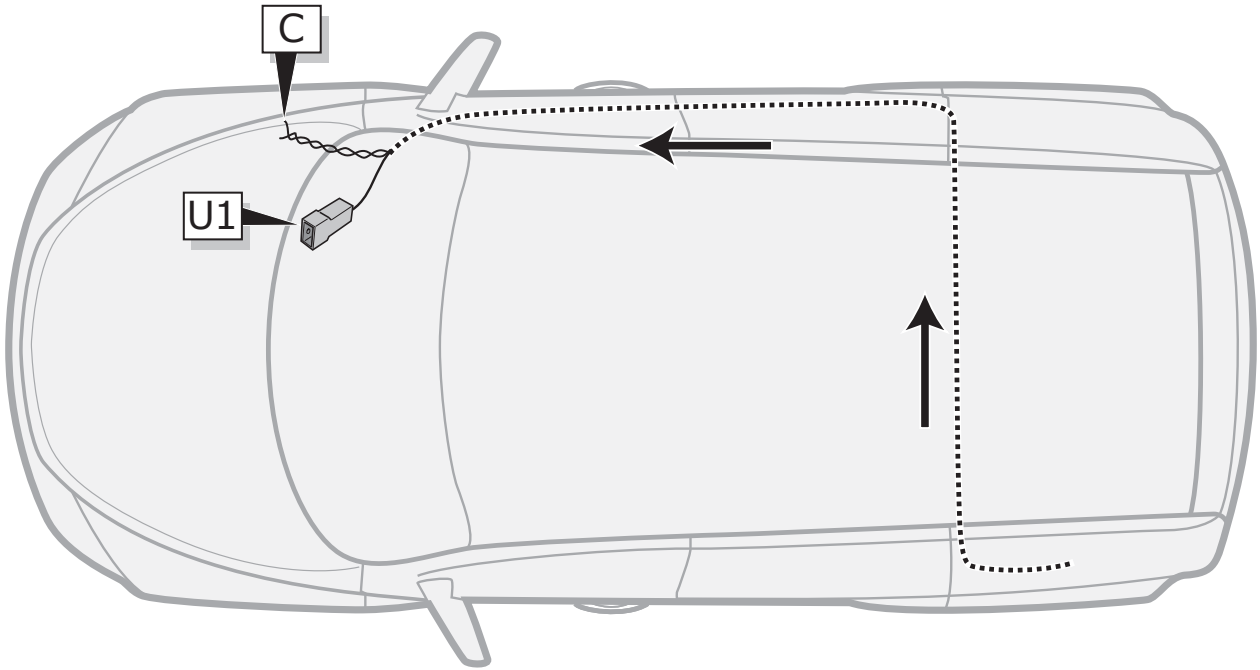

27

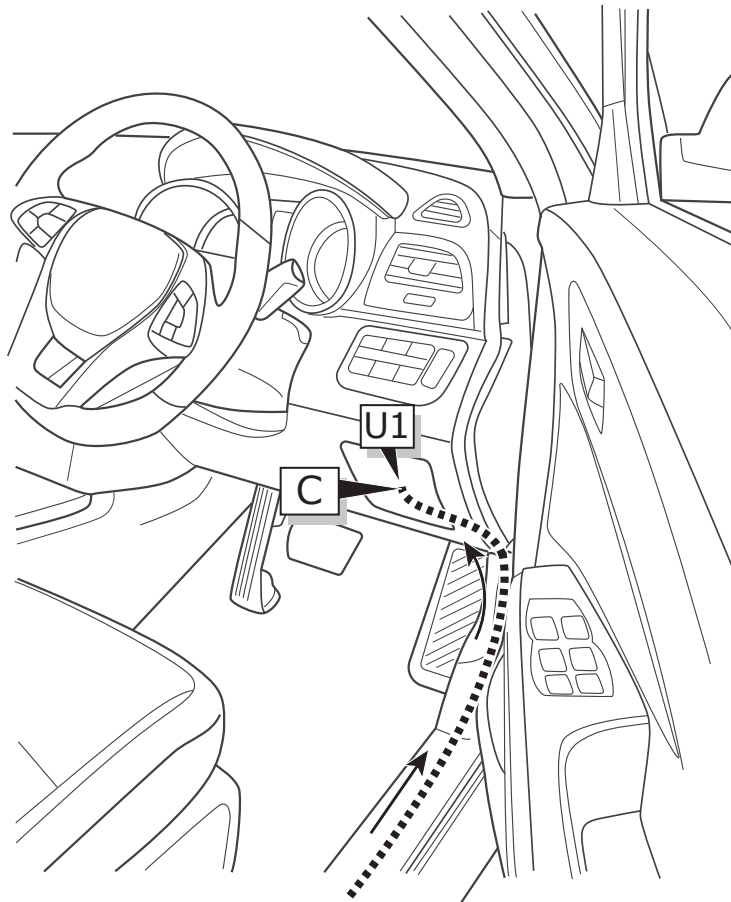

28

Korando

Tivoli X150

**CANBUS
Option 1**

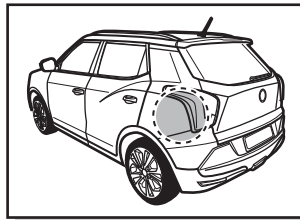
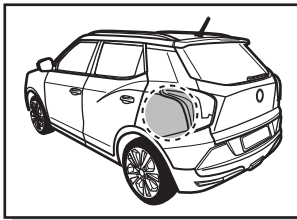
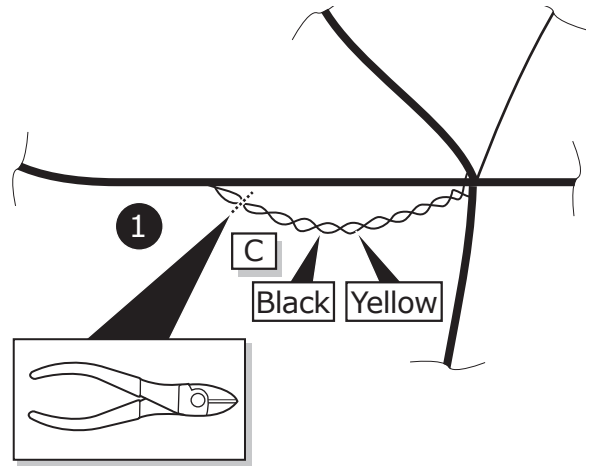
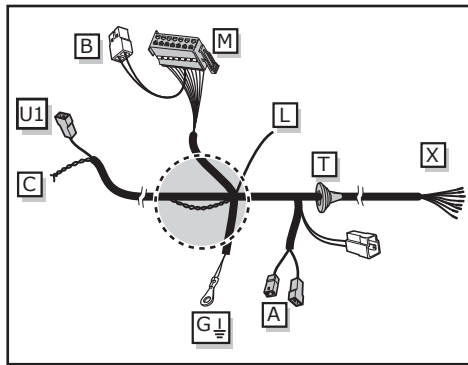

CAN-Data Wire

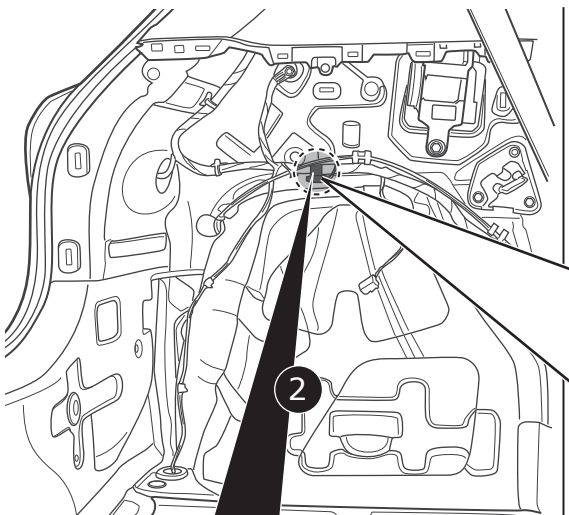

Remove tape

CAN-Bus
Joint-Connector!

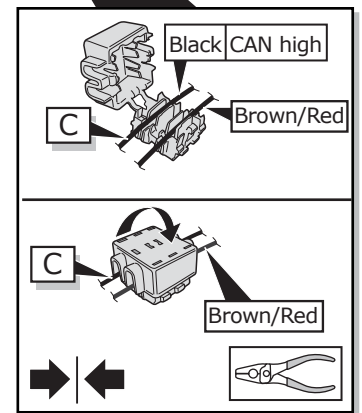
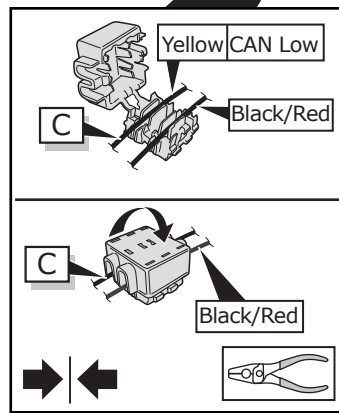
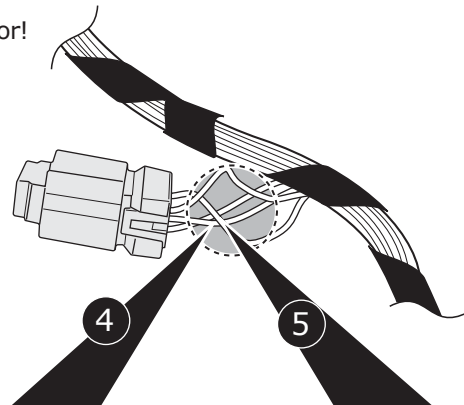

3

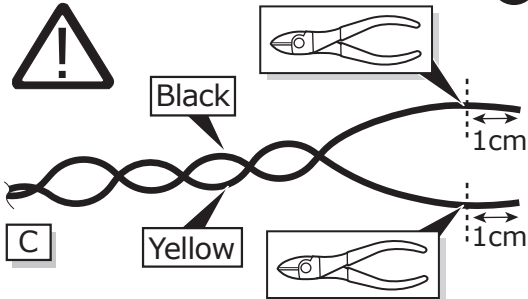

29

Korando

Tivoli X150

CANBUS Option 2

CAN-Data Wire

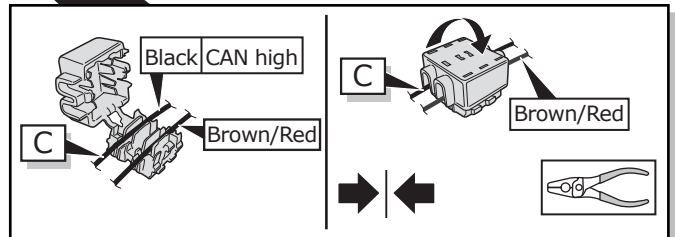
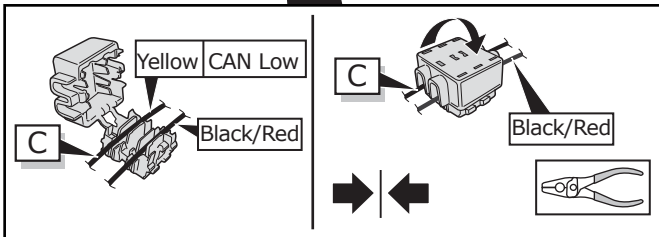
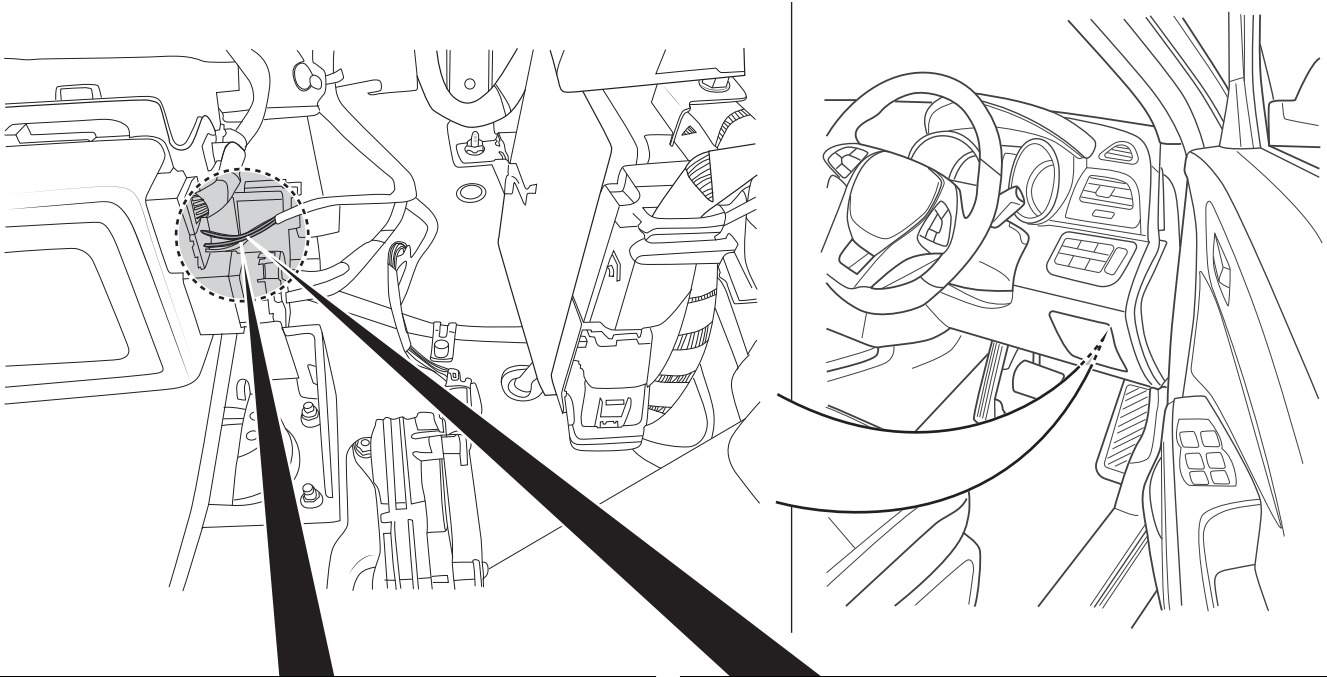
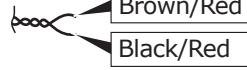

30

Tivoli Grand

**CANBUS
Option 1**

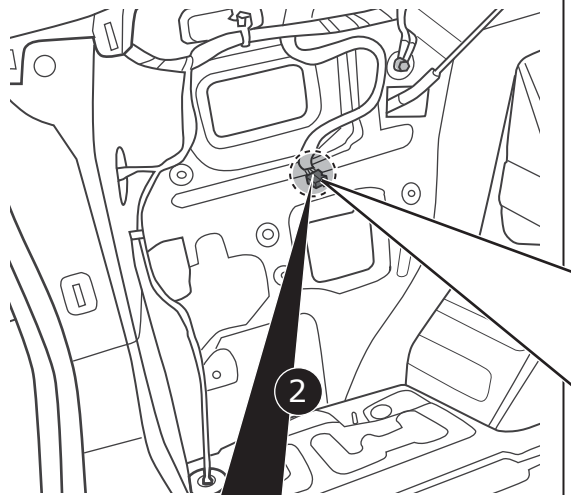
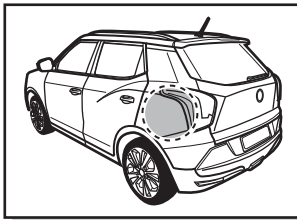
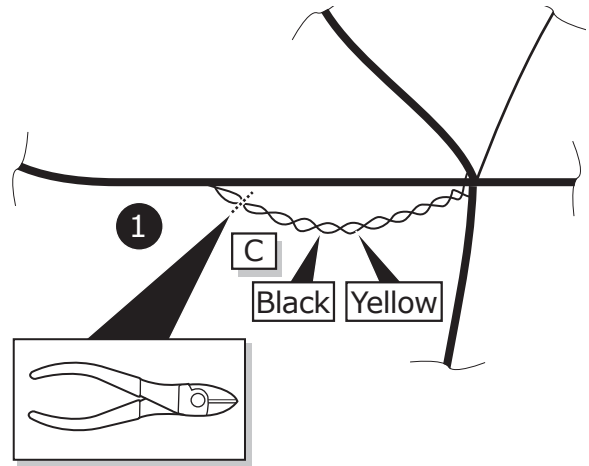
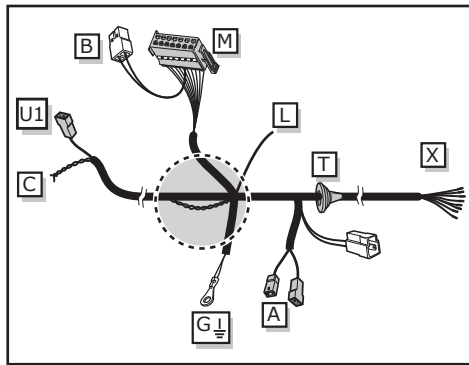

Remove tape

CAN-Bus
Joint-Connector!

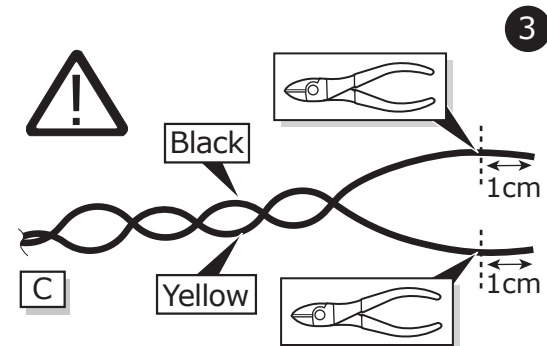
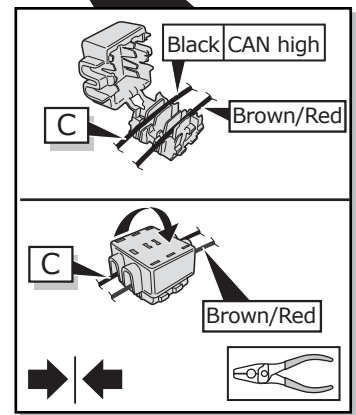
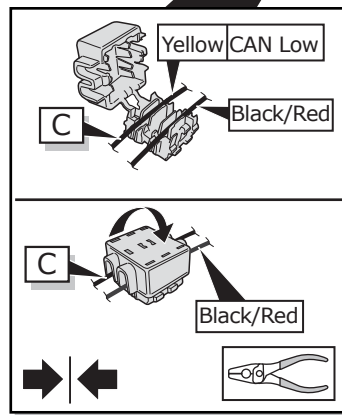
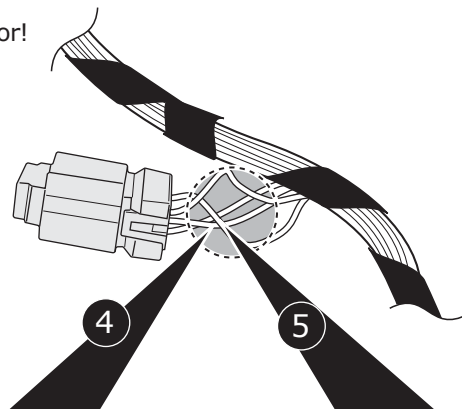

31

Tivoli Grand

**CANBUS
Option 2**

CAN-Data Wire

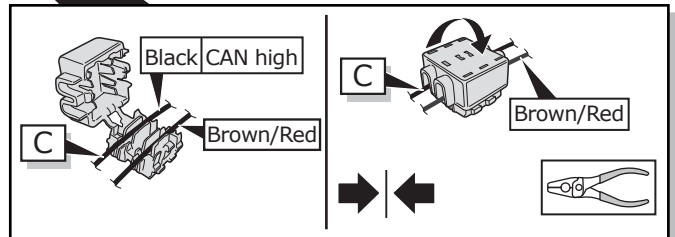
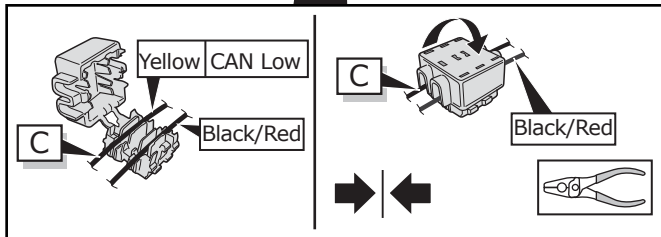
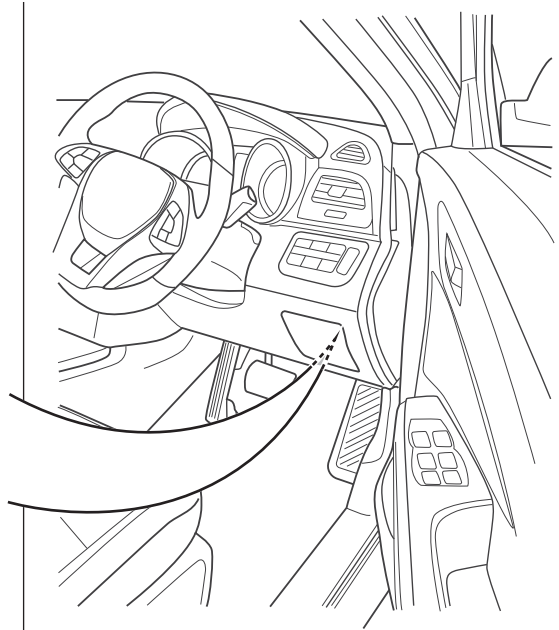
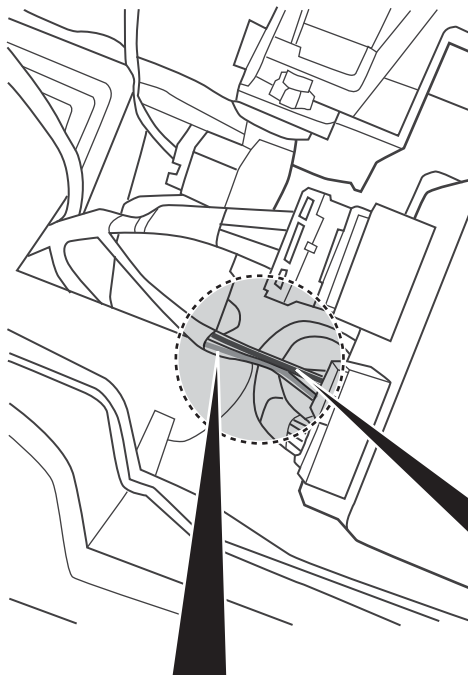
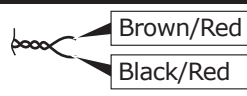

32

**CANBUS
Option 1**

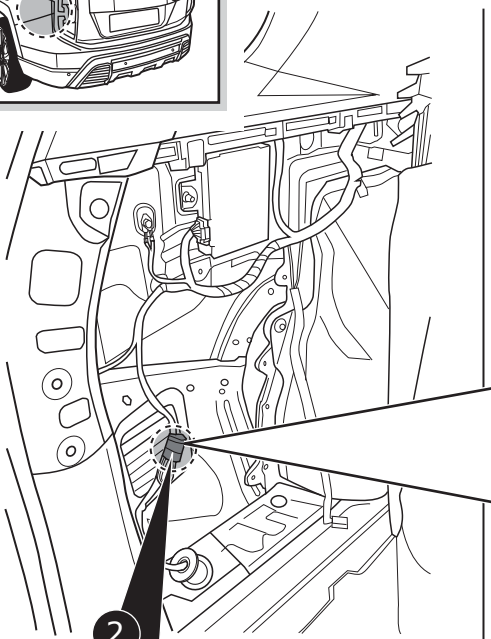
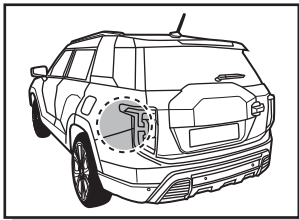
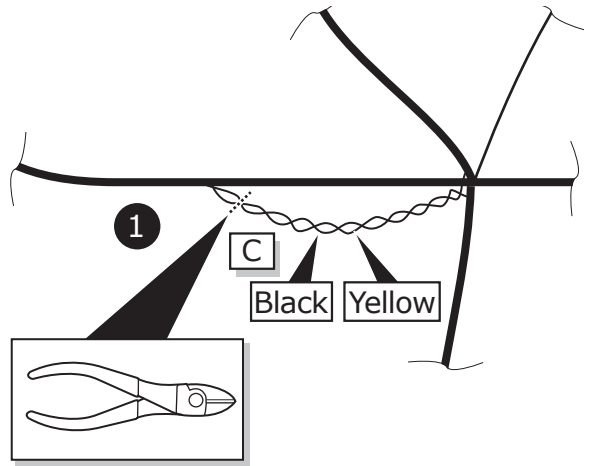
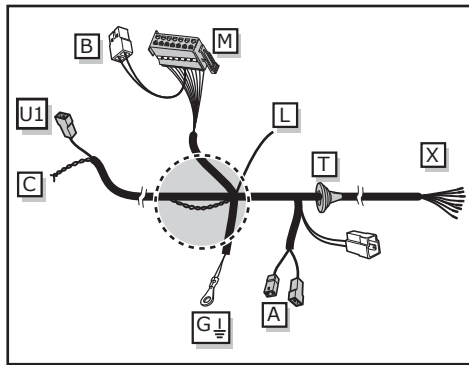

Remove tape

CAN-Bus
Joint-Connector!

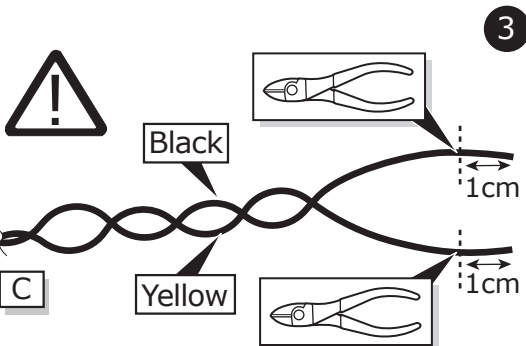
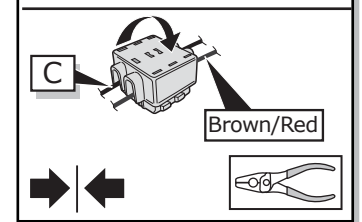
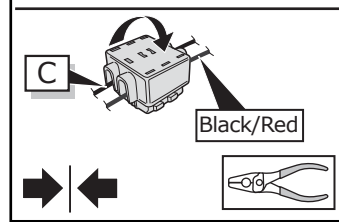
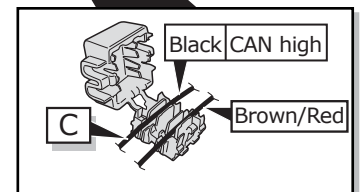
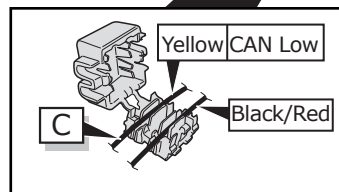
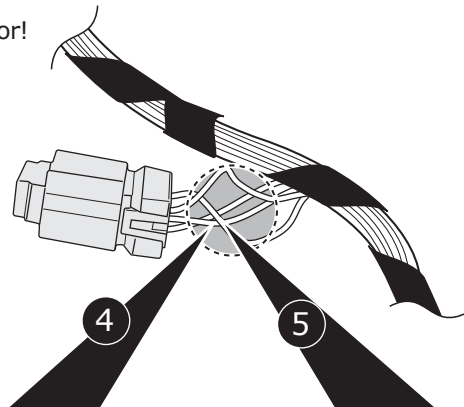

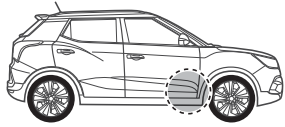

CAN-Data Wire

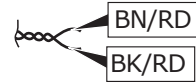

Torres

**CANBUS
Option 2**

Black Connector
77-pin

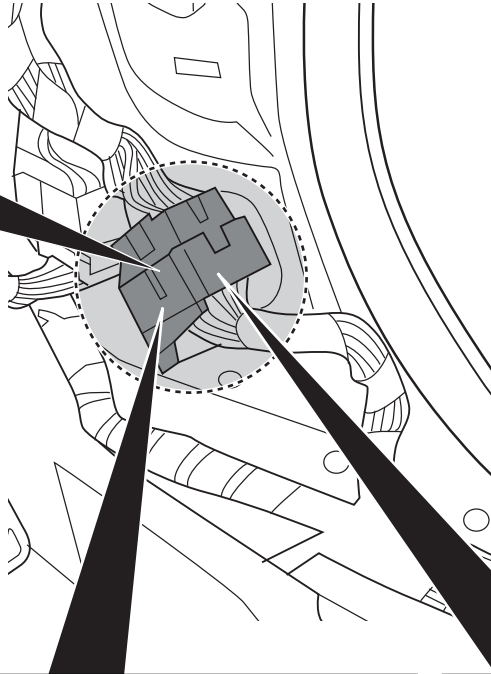

Black Connector
77-pin

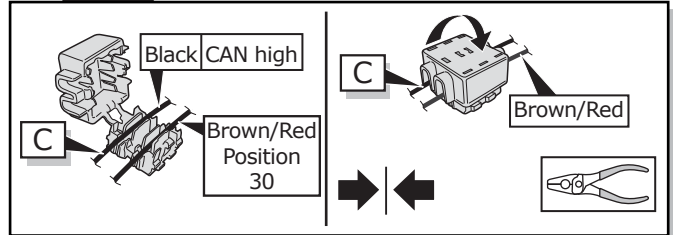
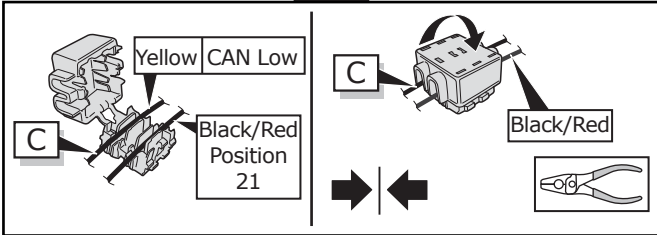
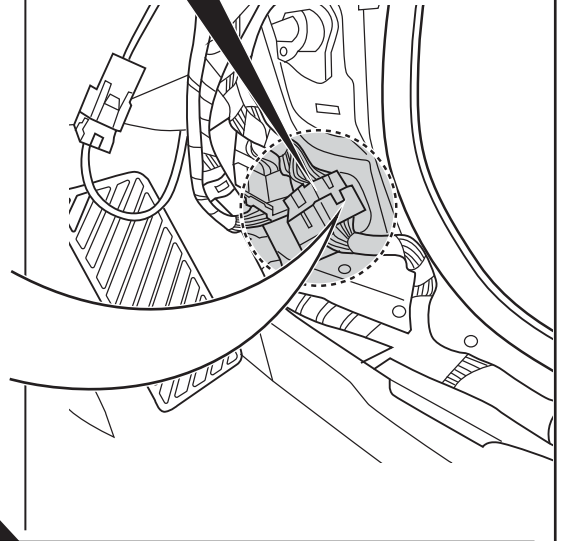

34

Actyon

CANBUS Option 1

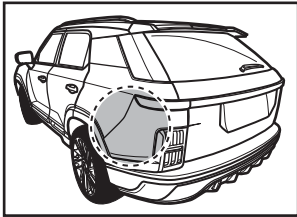
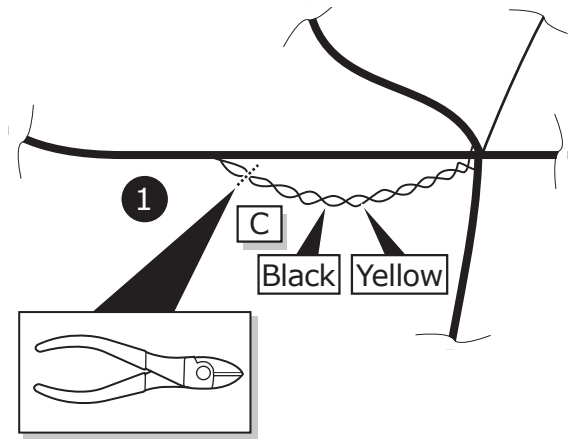
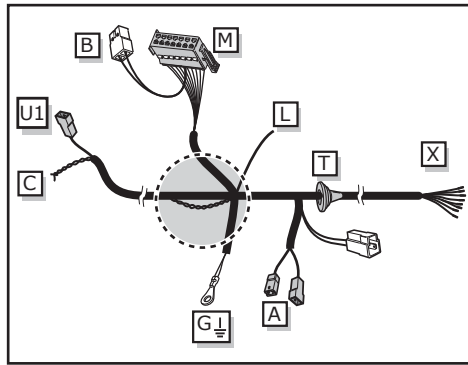

CAN-Data Wire

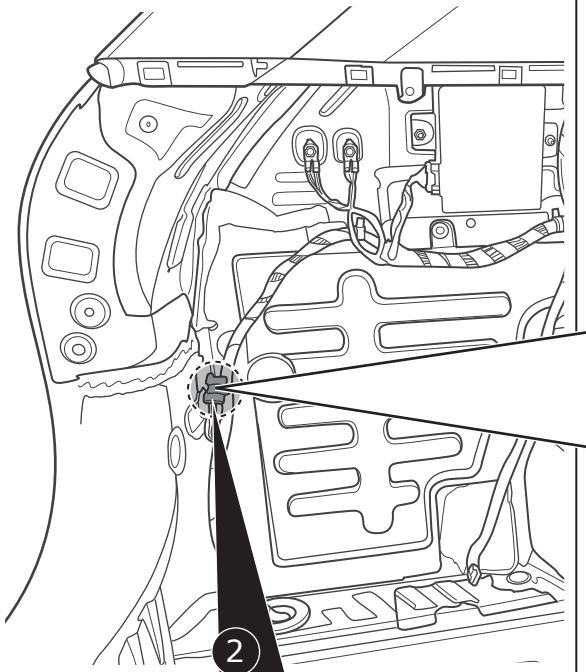

CAN-Bus Joint-Connector!

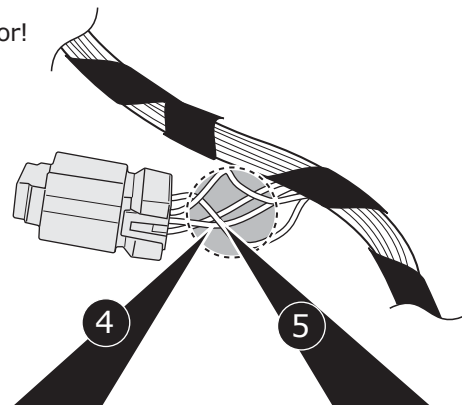

- | | |
|----------------------------------|---------------------------|
| (DE) Klebeband entfernen | (CZ) Odstraňte pásku |
| (FR) Enlevez Ruban adhésif | (DK) Aftag tapen |
| (NL) Tape verwijderen | (FI) Poista teippi |
| (GB) Remove tape | (GR) Αφαιρέστε την ταινία |
| (ES) Retirar la cinta adhesiva | (NO) Fjern limbandet |
| (IT) Rimuovere il nastro adesivo | (PL) Zdjąć taśmę |
| (SE) Avlägsna klisterbandet | |

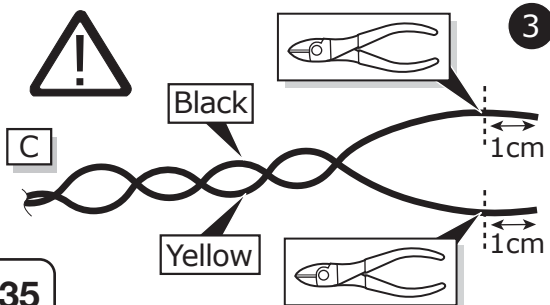
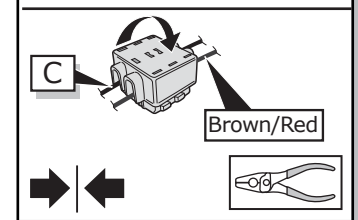
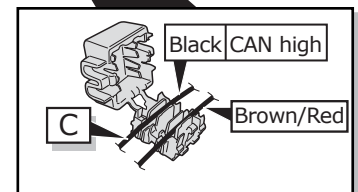
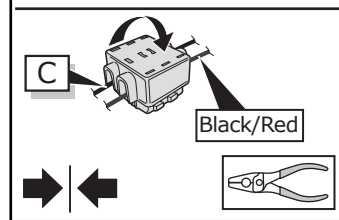
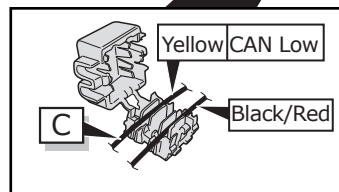

35

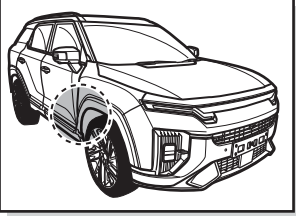

CAN-Data Wire

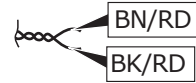

Actyon

CANBUS Option 2

Black Connector
77-pin

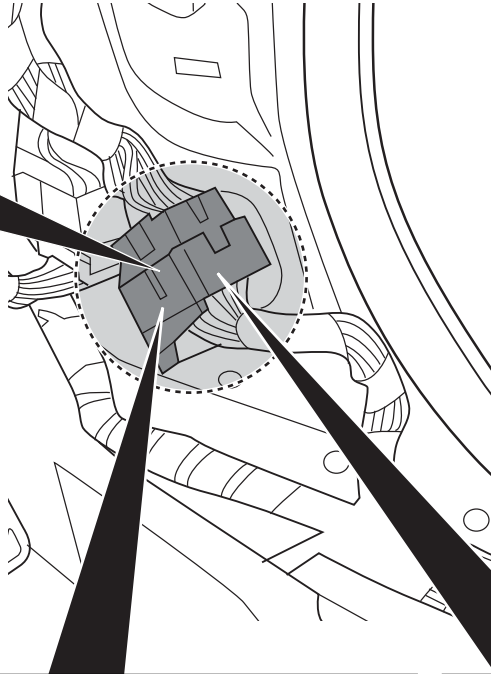

Black Connector
77-pin

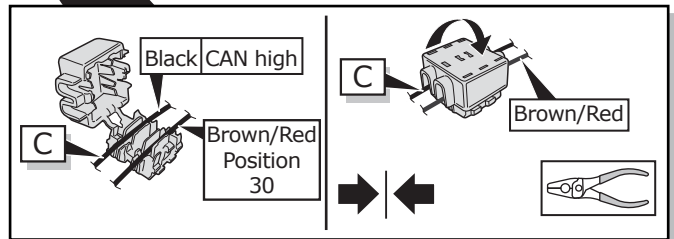
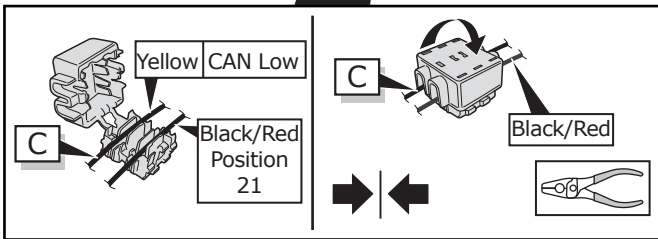
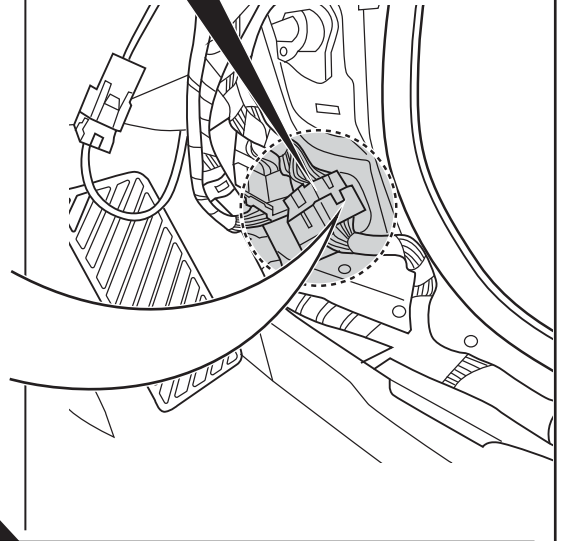

36

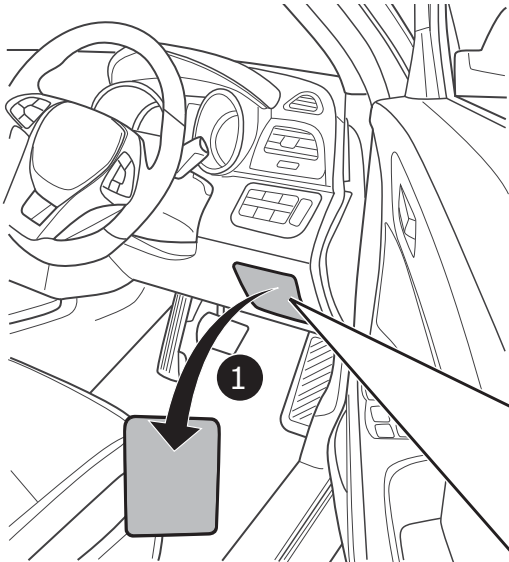

Korando
Torres
Actyon

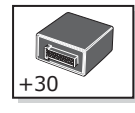
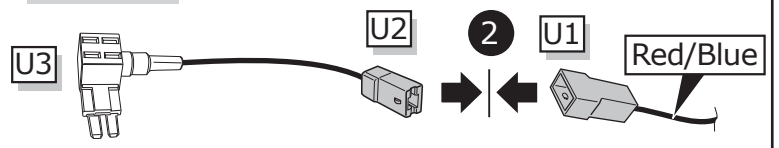

Important!
 Please do not mount
 the fuse tap and its
 wiring output in
 the other
 direction!

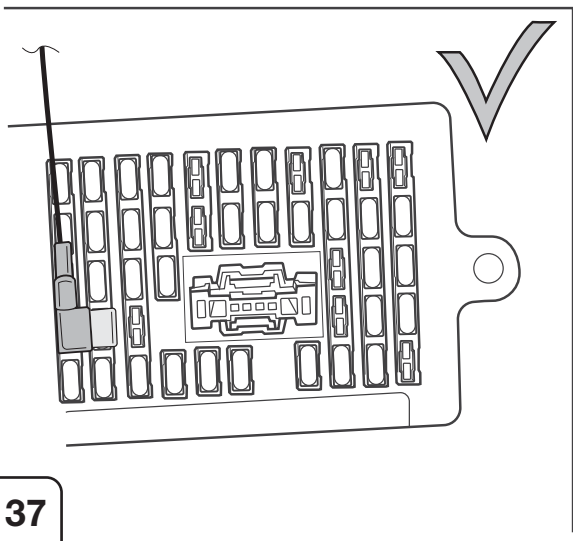
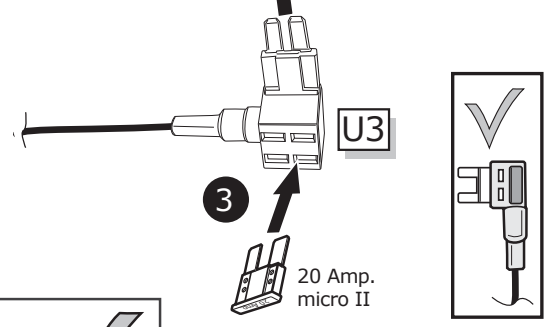
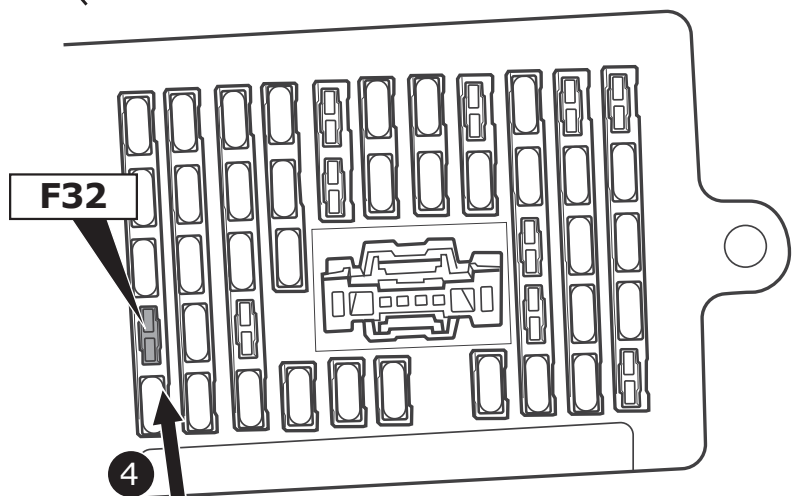

37

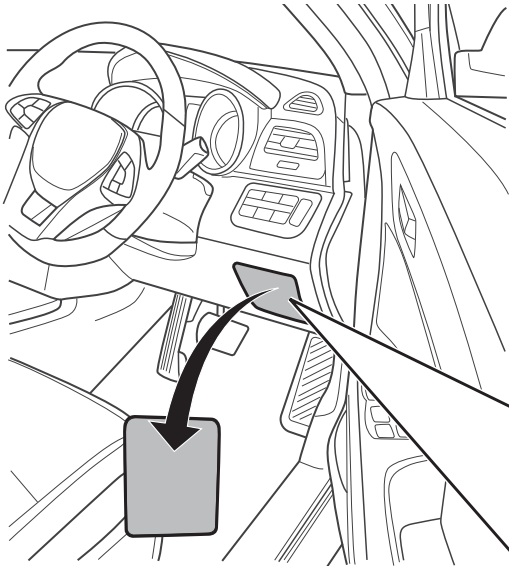

Tivoli X150

Tivoli Grand

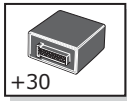
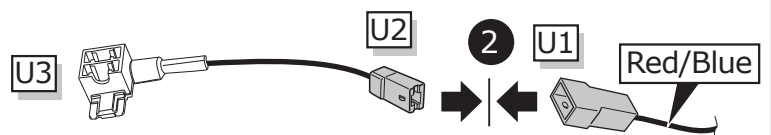

Important!
Please do not mount the fuse tap and its wiring output in the other direction!

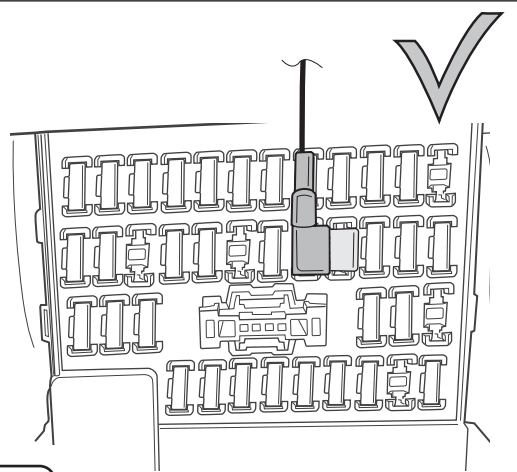
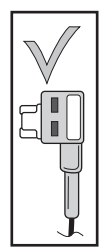
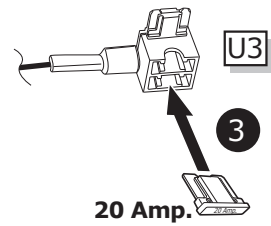
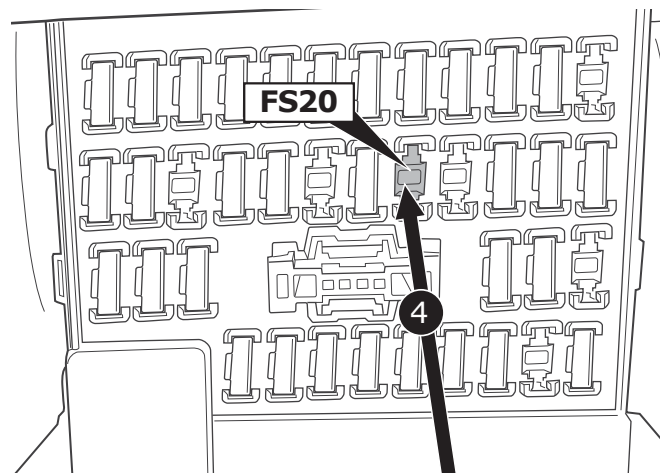

38

Optional

MAX = 21W

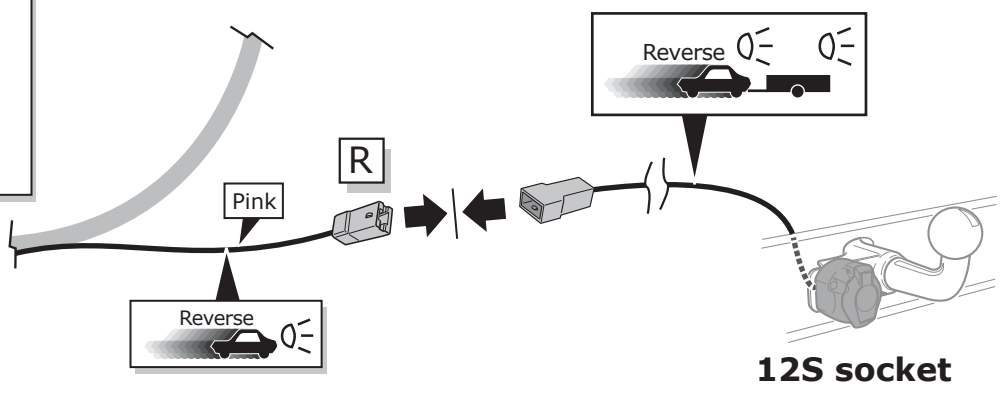
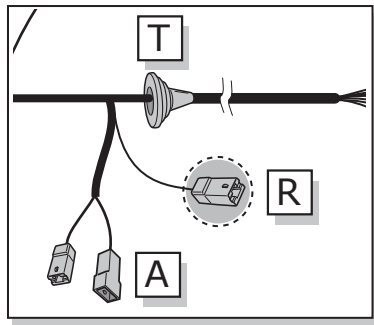

39

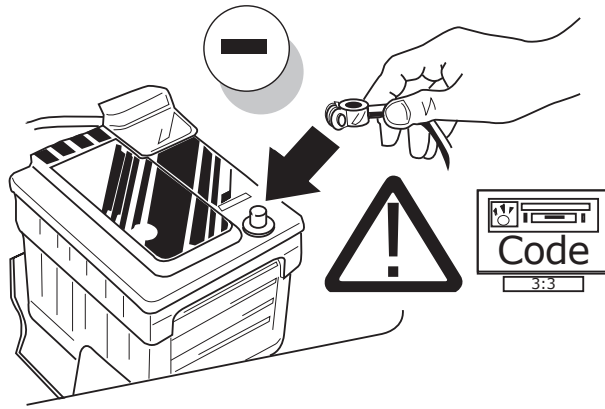

40

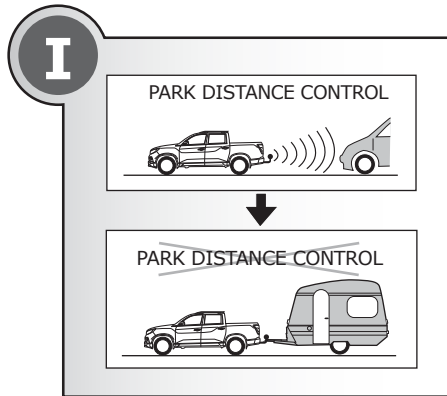
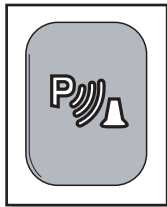

During trailer operations, the rear park distance control will be deactivated automatically. Due to systemic reasons, an acoustic activation indication will be carried out sporadically!

41

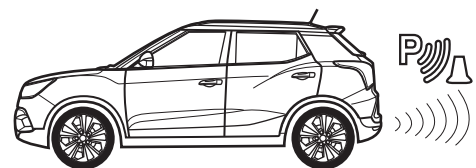
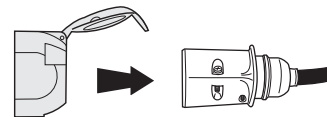
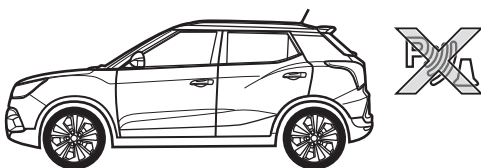
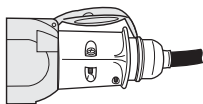

42

Functional test

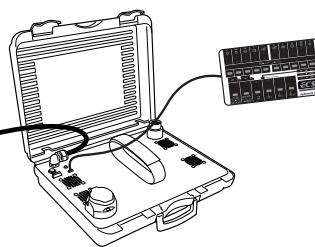
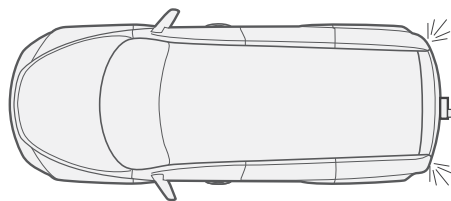
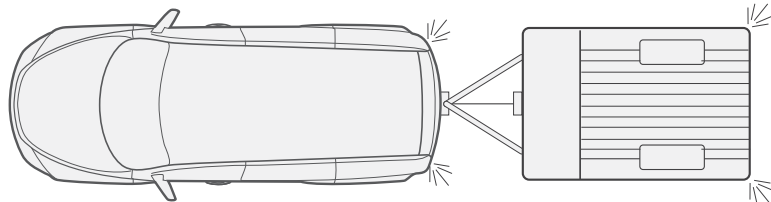
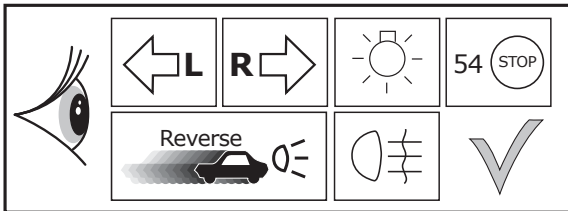

LIGHTMATE

ECS part no.
LIGHTMATE II
LIGHTMATE III

43

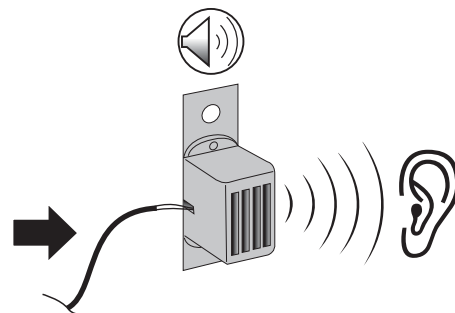
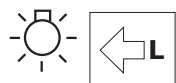
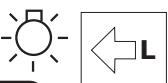
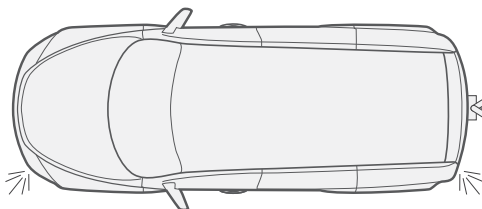
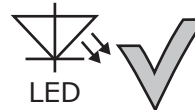
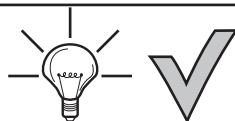

44

The following light functions for the trailer are **not supported** by all towing vehicles with **DRL circuit**:

- Rear lights
- Side lights
- Numberplate lights

The **taillights or dimmed headlights** must be switched on to activate this function!

45

Optional

Adapter socket

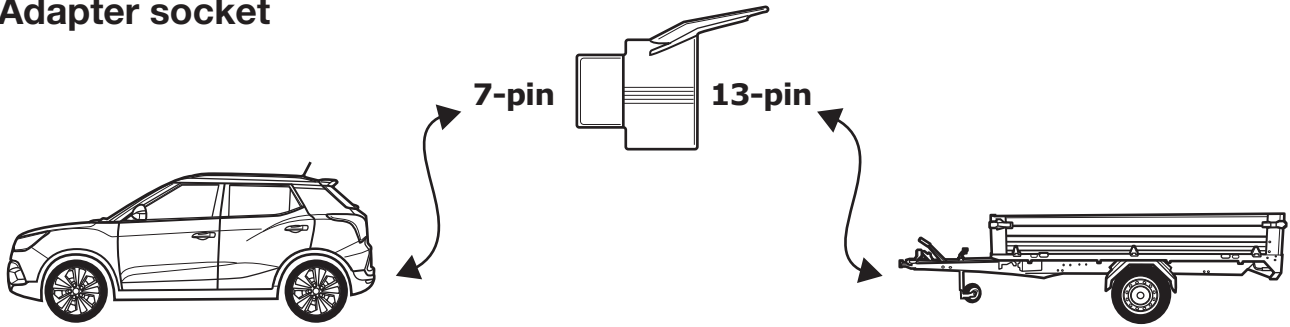

46

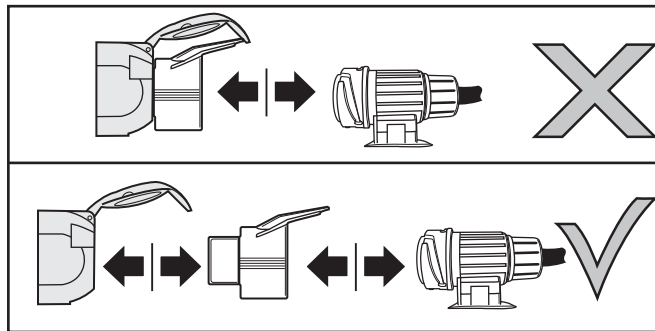
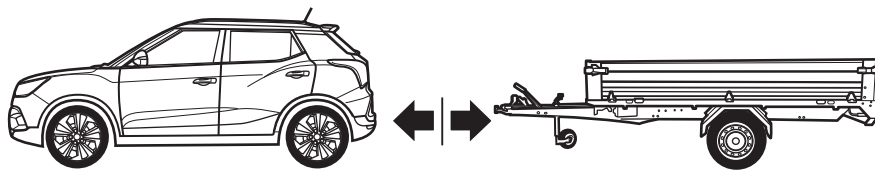

47

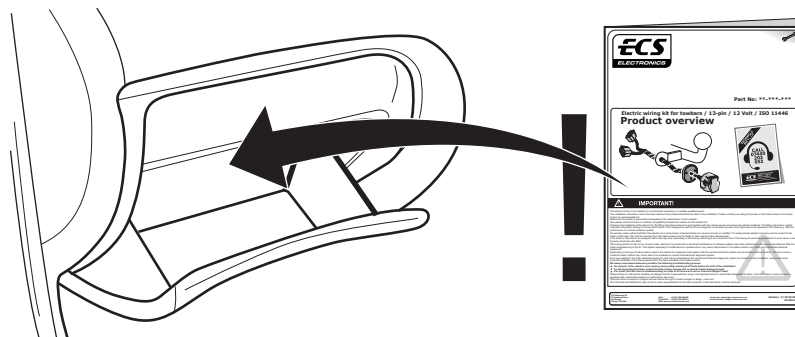

48

SOCKET CONNECTION

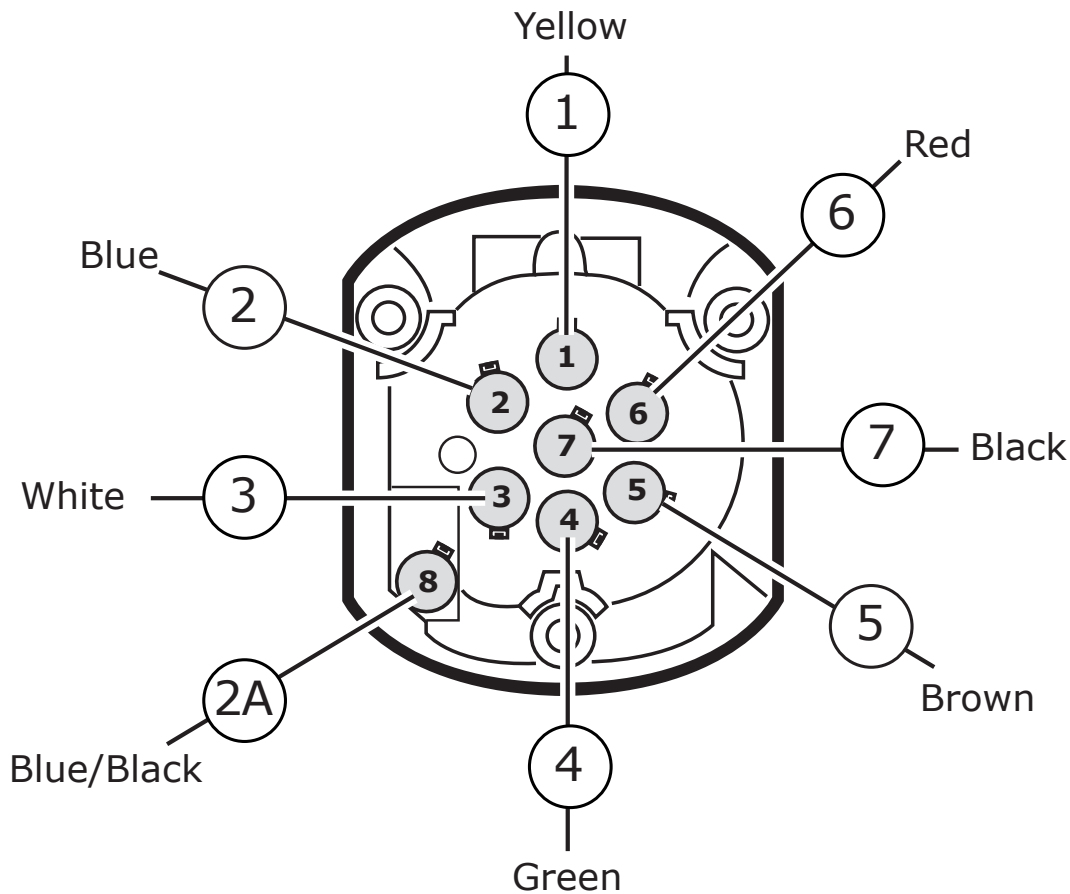
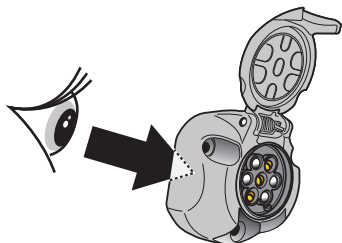

SOCKET CONNECTION

DIN/ISO 1724								
Pmax	21W	2x21W		21W	52W	3x21W	52W	
	Yellow	Blue	White	Green	Brown	Red	Black	Blue/Black