

Volvo C70 02/2006-

Partnr.: VL-022-BXU

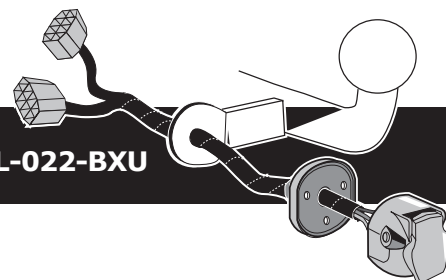

- Fitting instructions electric wiring kit tow bar with 12-N socket up to DIN/ISO Norm 1724.
- We would expressly point out that assembly not carried out properly by a competent installer will result in cancellation of any right to damage compensation, in particular those arising by virtue of the product liability act.
- Contents of these kits and their fitting manuals are subject to alteration without notice, please ensure that these instructions are read and fully understood before commencing installation.
- Do not overload circuits; the maximum loads per connection are detailed in this manual.
- Attention! Before Installation, please read this manual carefully and inform your customer to consult the vehicle owners manual to check for any vehicle modifications required before towing.
- In the event of functional problems, troubleshooting must be limited to about 0.5 hours, contact the technical support:
t.skinner@ecs-electronics.com / 07440 202 052.



Part list

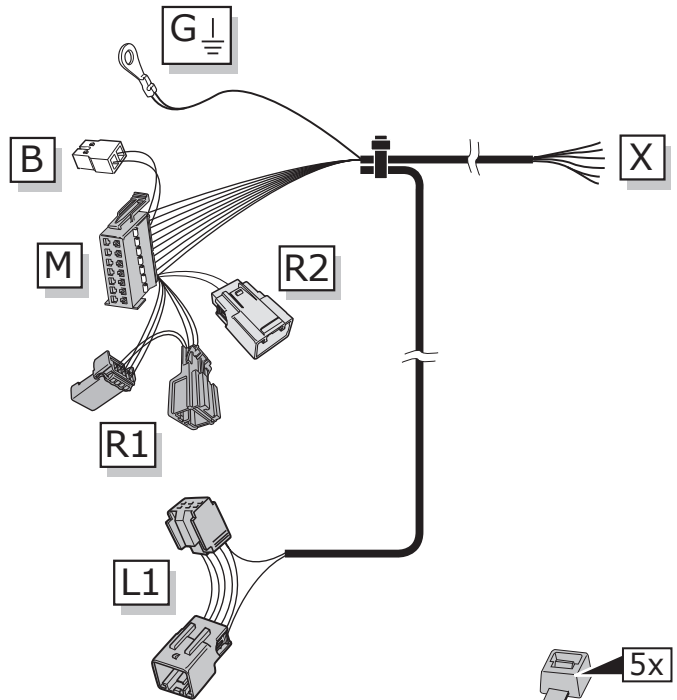
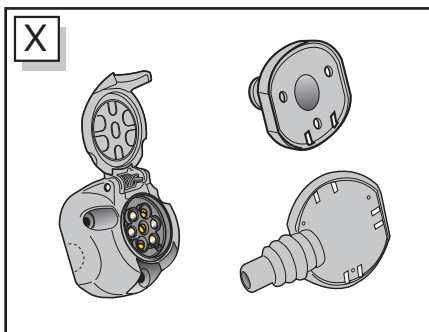
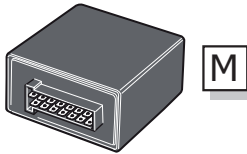
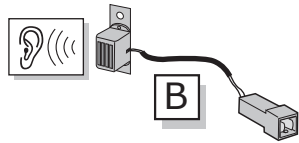
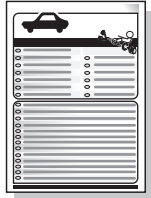
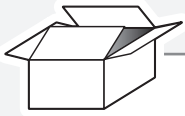

UN-243-YZ
 Optional reverse lamp
 pre-wire extension included

Pag. 11

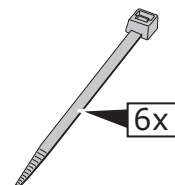
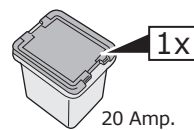
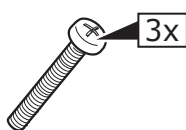

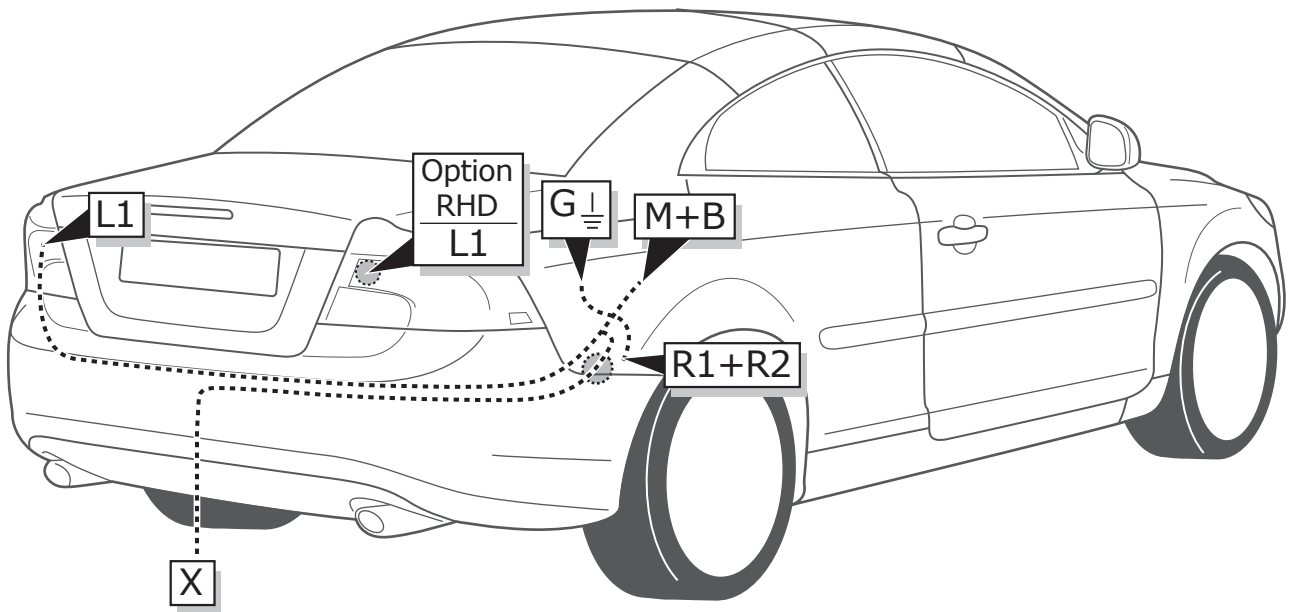

1

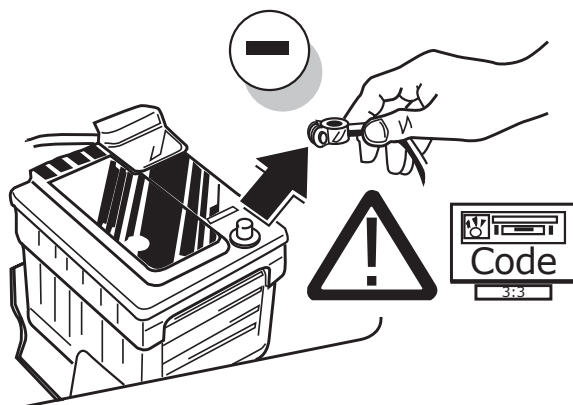

2

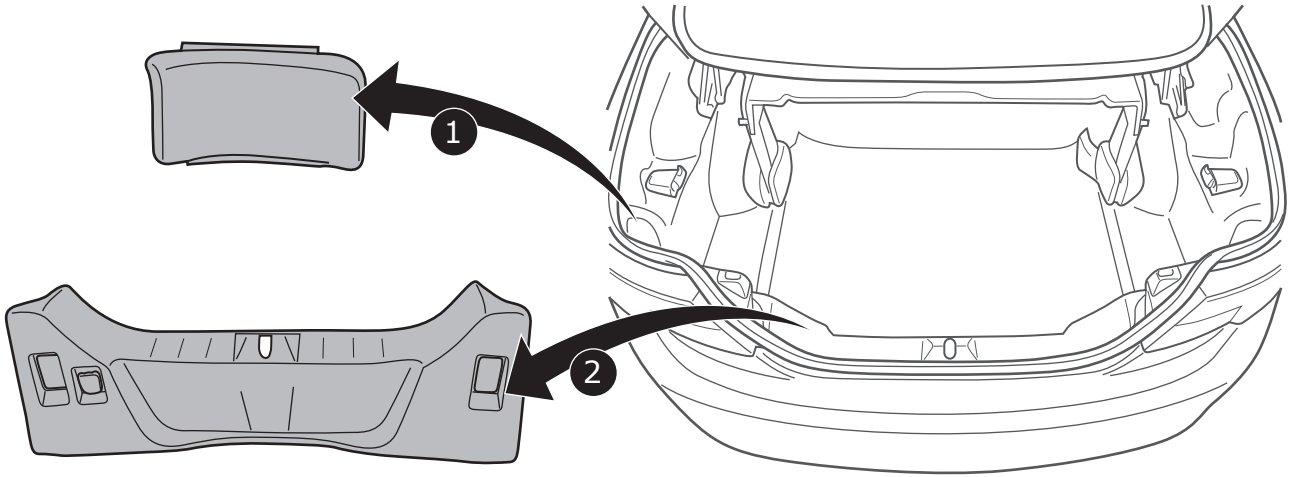

3

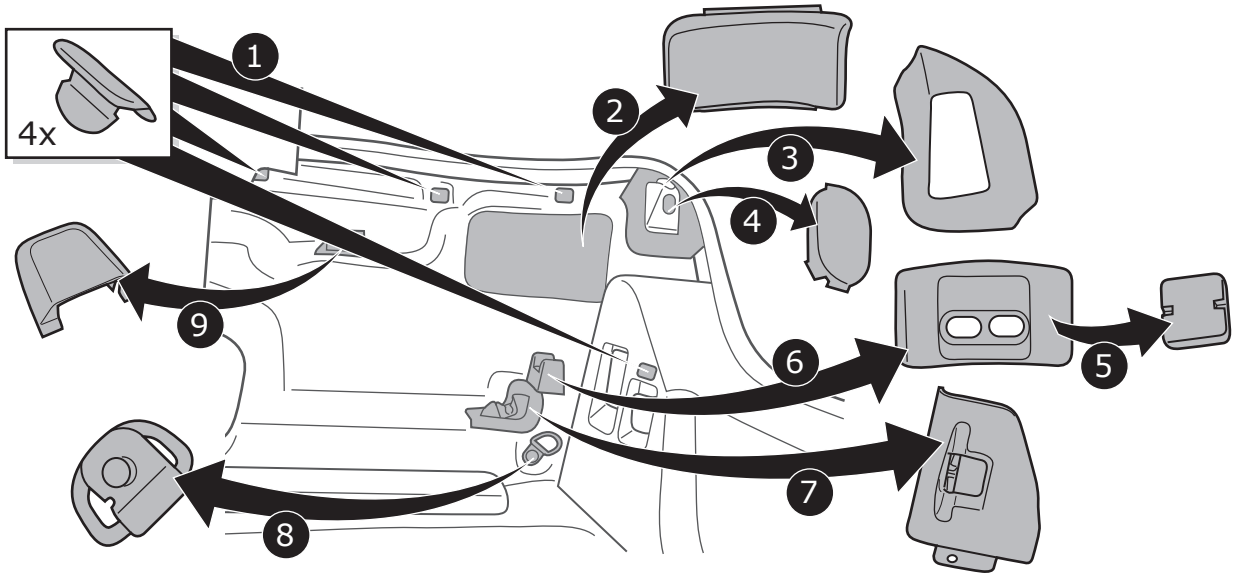

4

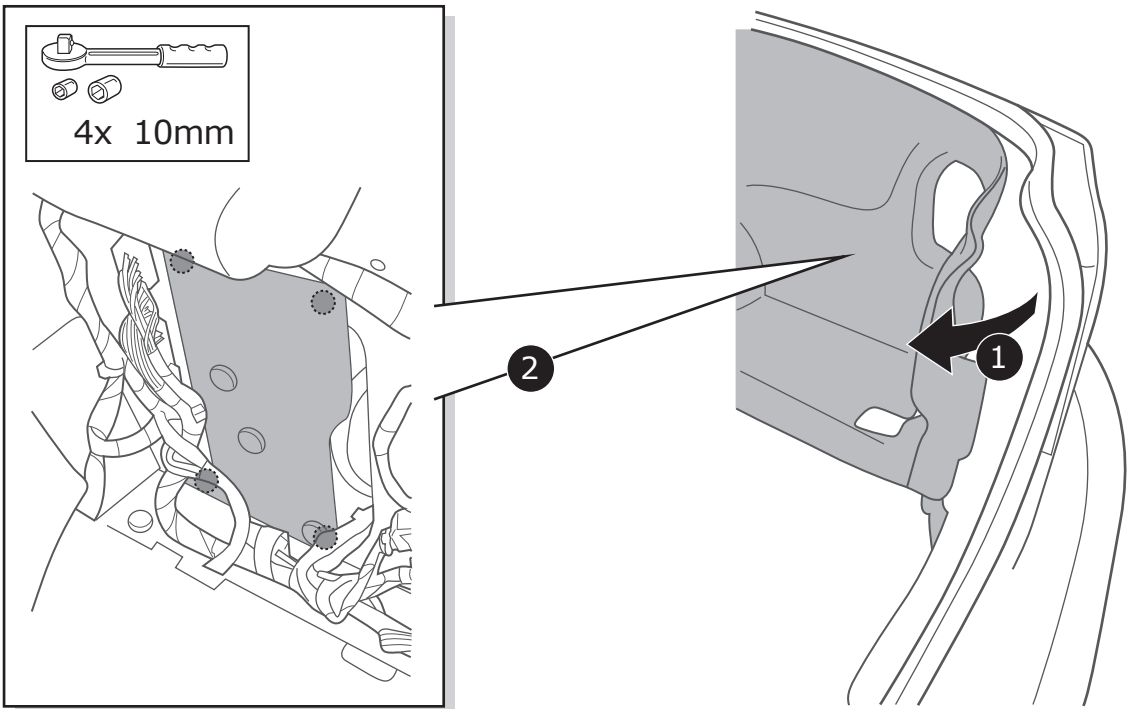

5

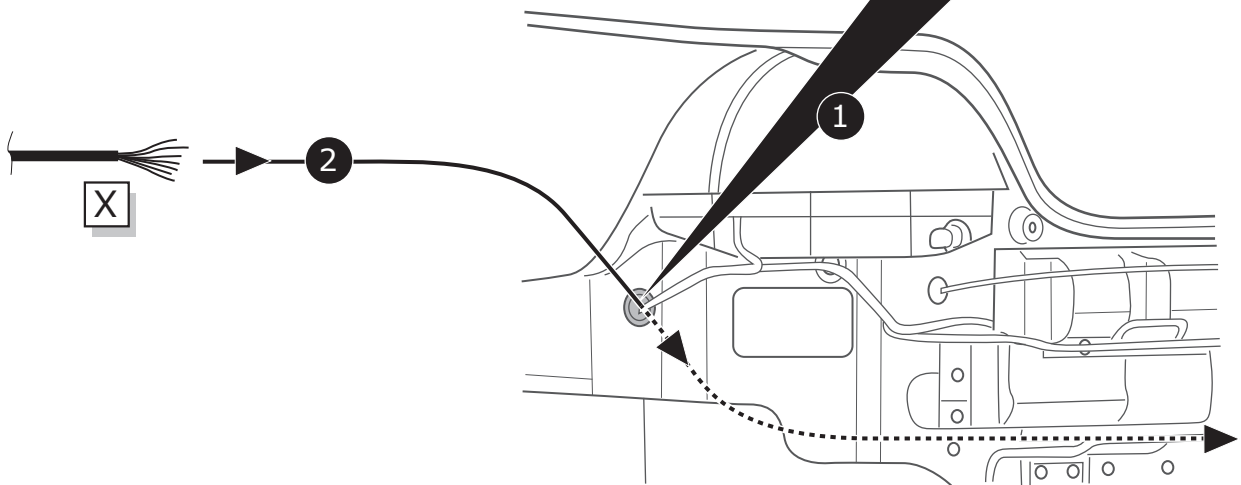
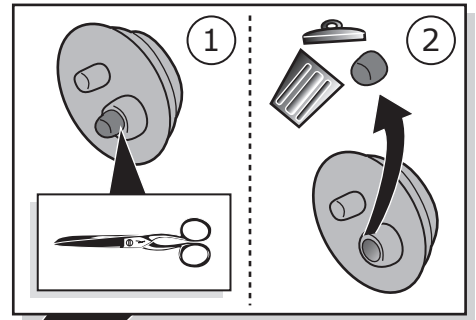
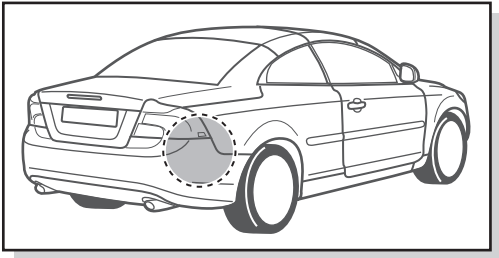

A

Option 1

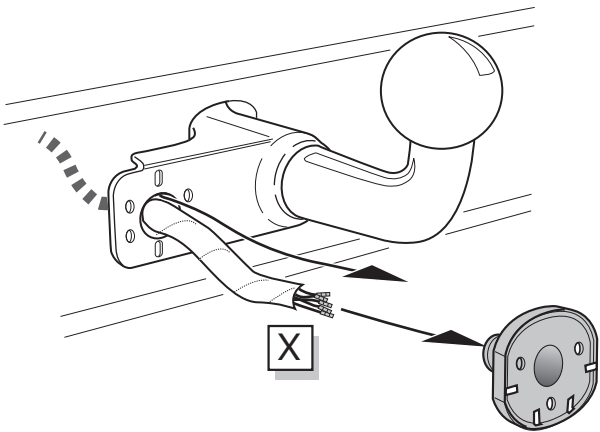

Option 2

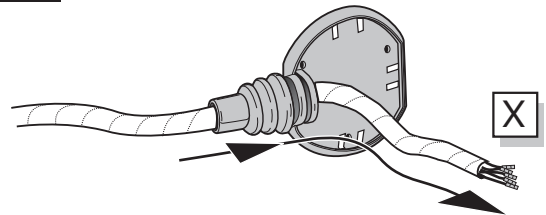

Option 3

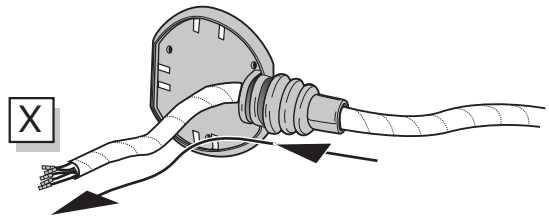

INFO

SOCKET CONNECTION 

Pag. 10

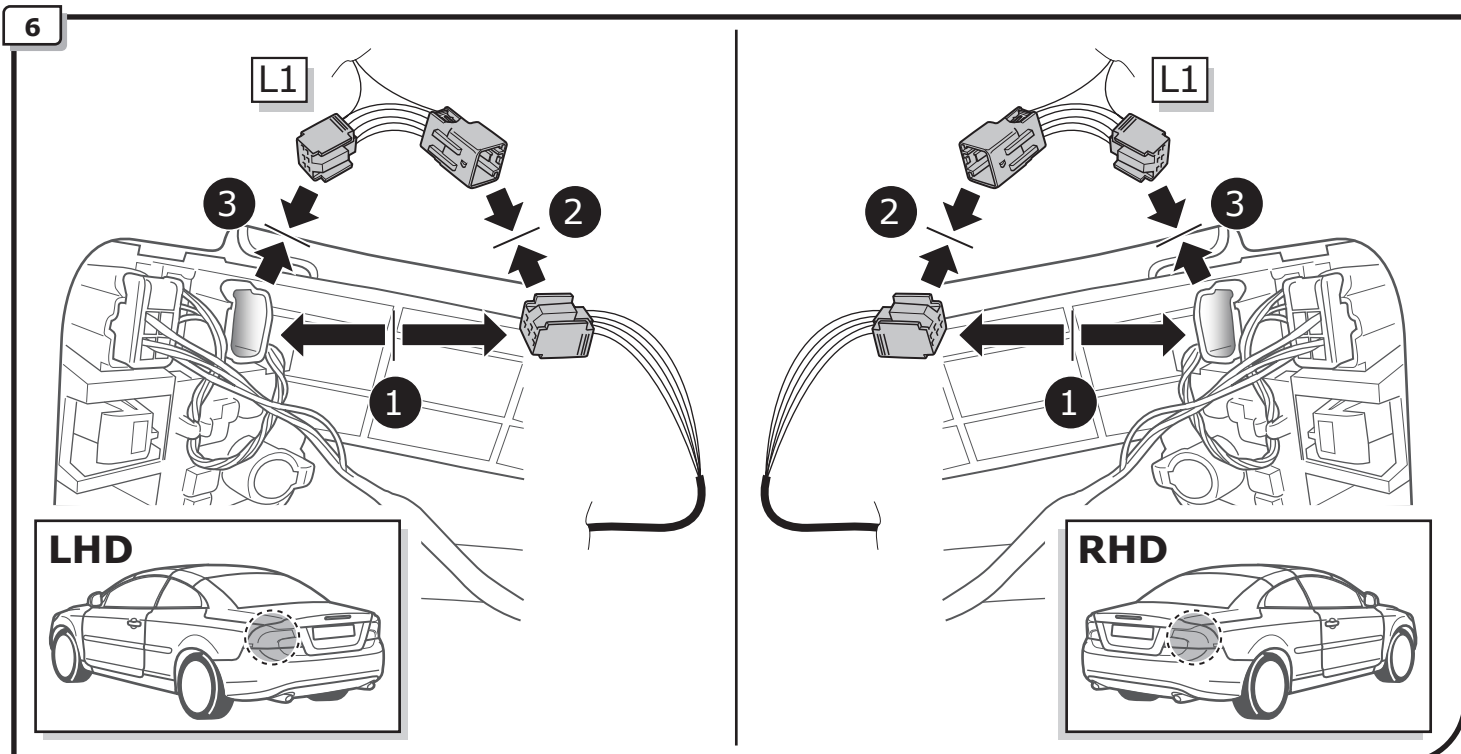
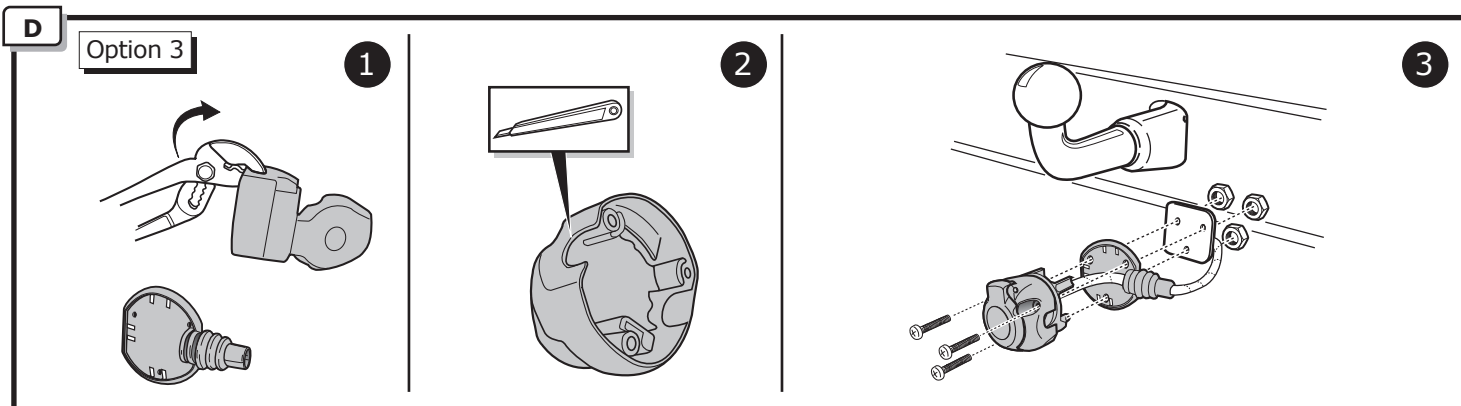
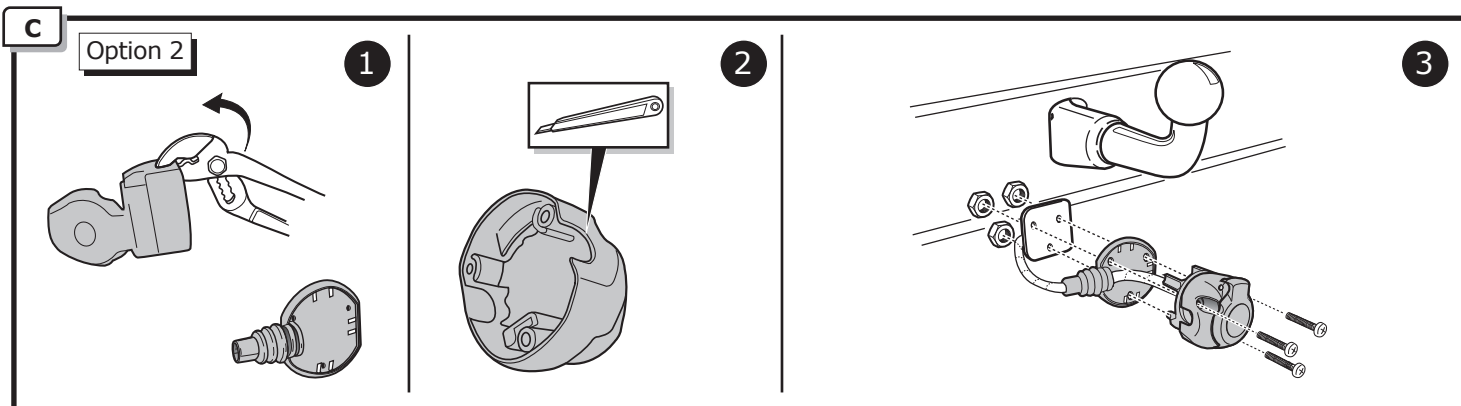
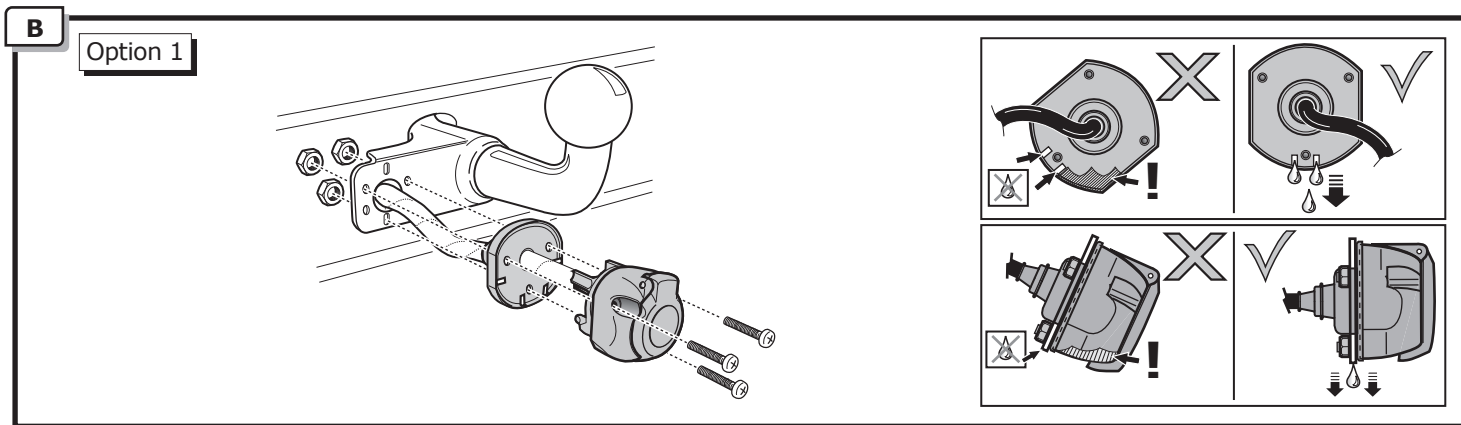

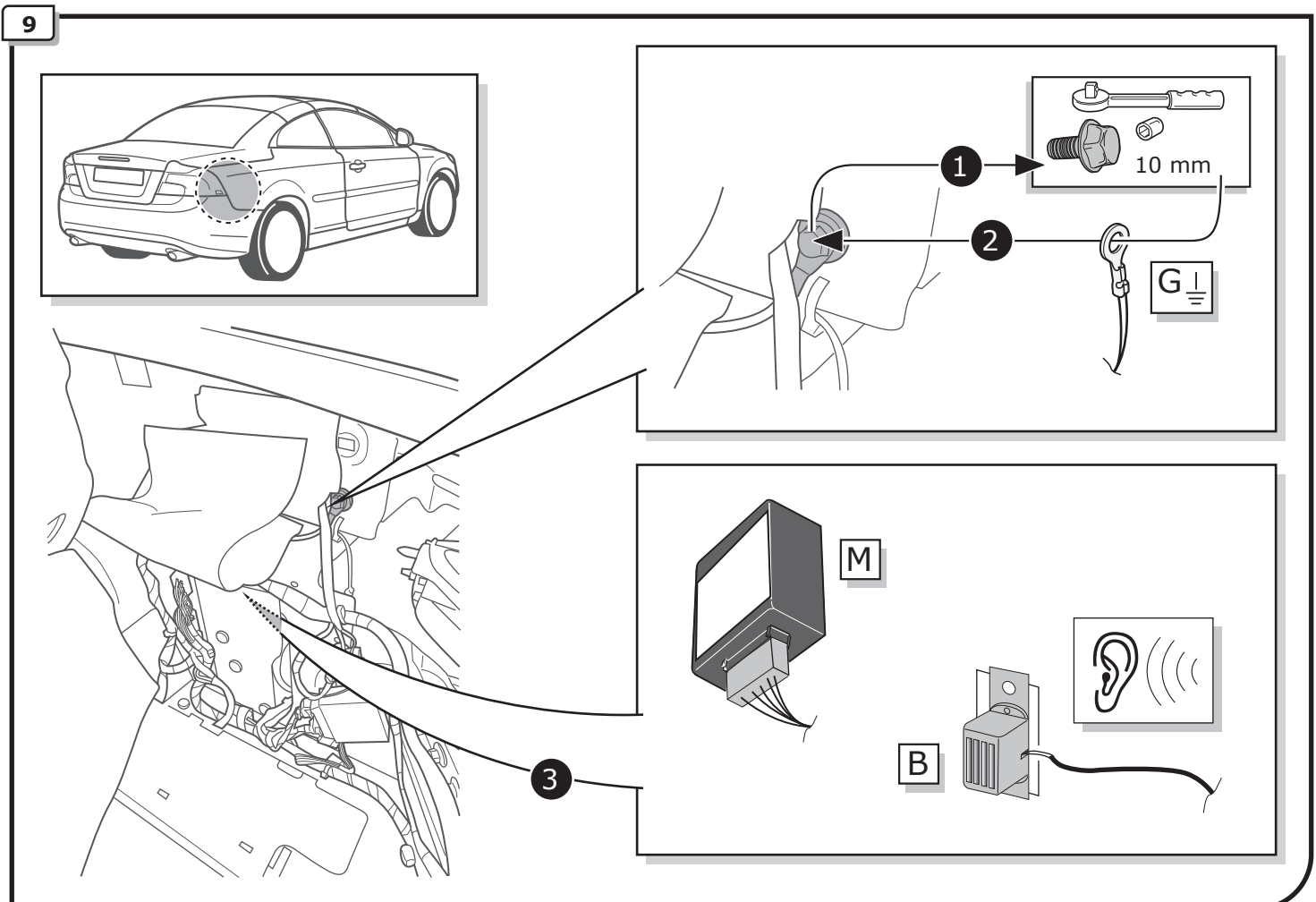
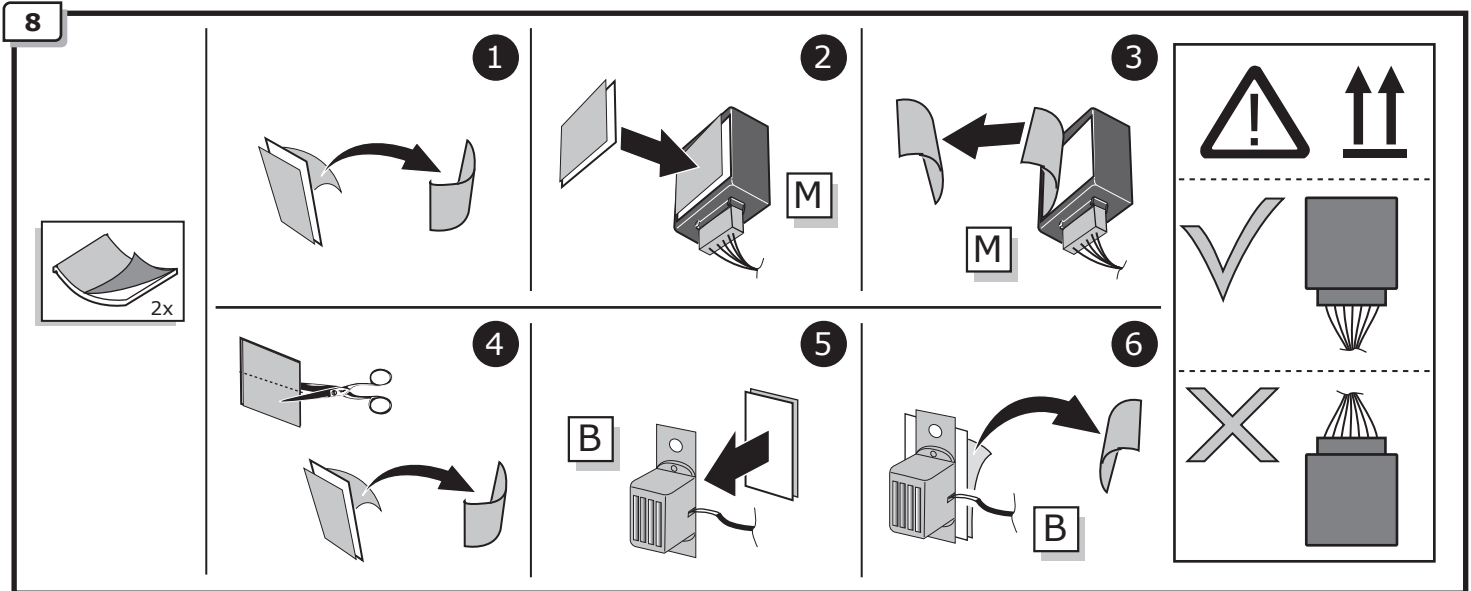
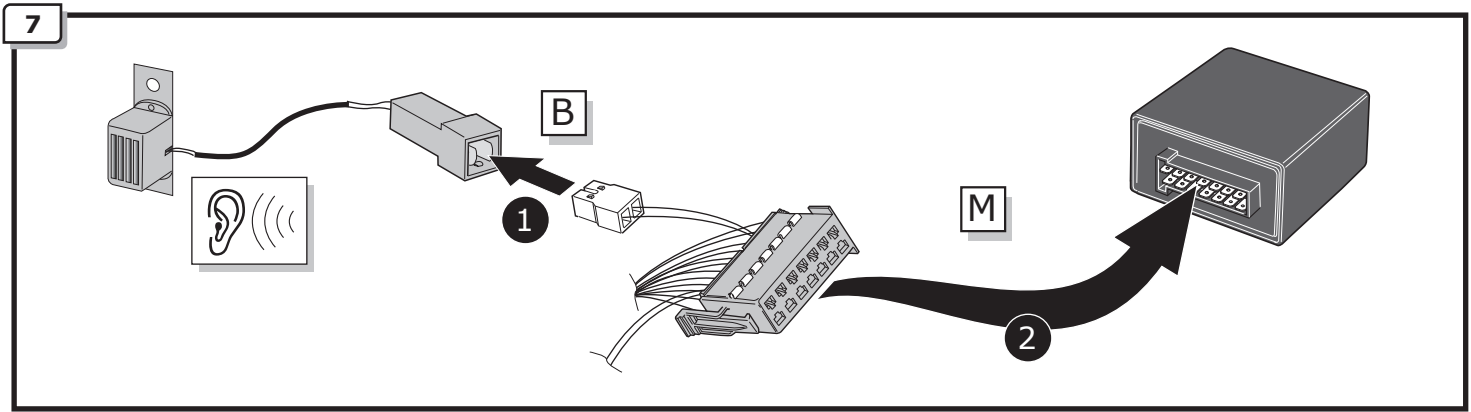

10

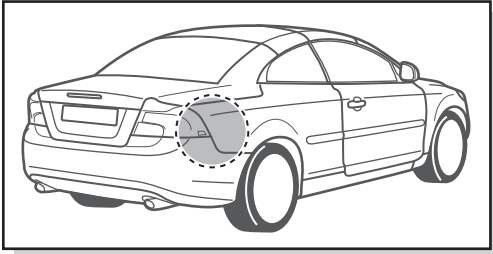

1

Remove tape.

R2

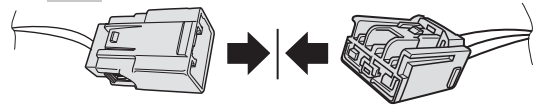

2

Remove tape.

R1

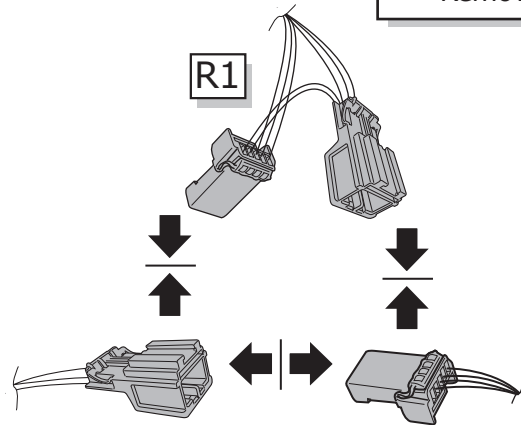

11

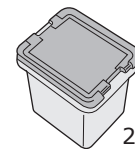
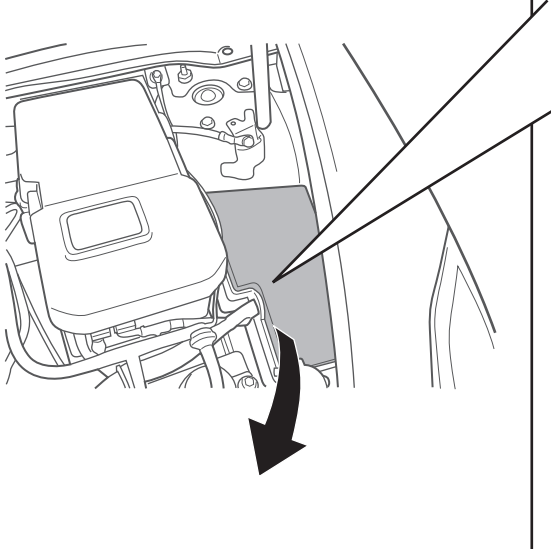
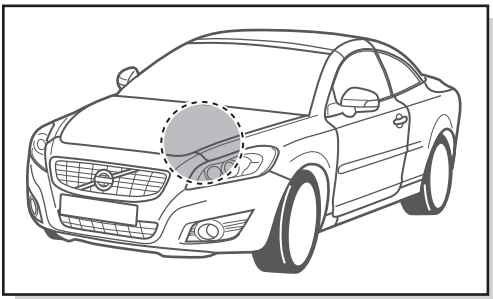

20 Amp.

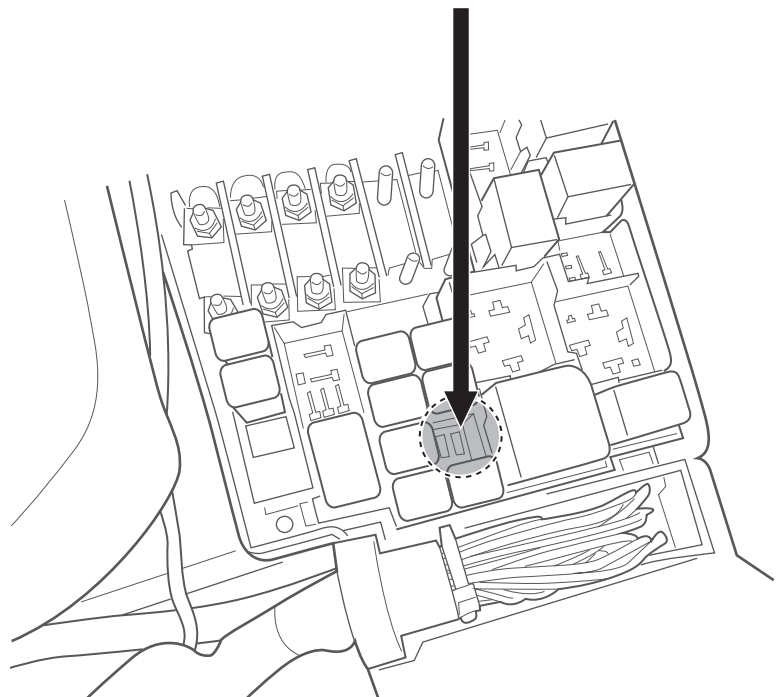

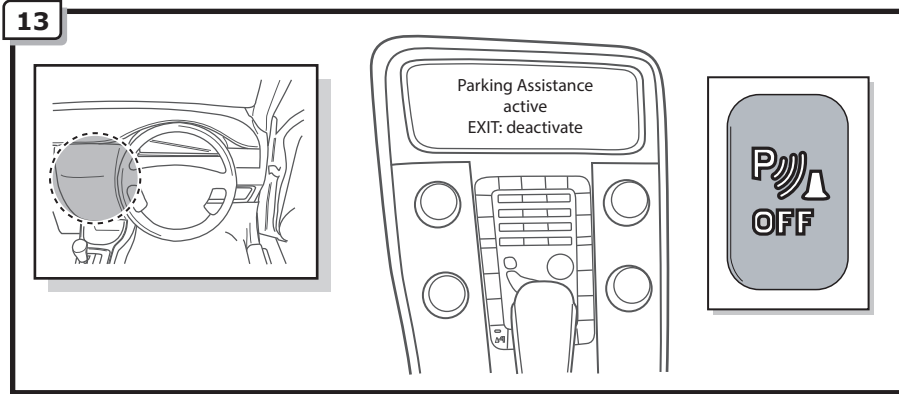
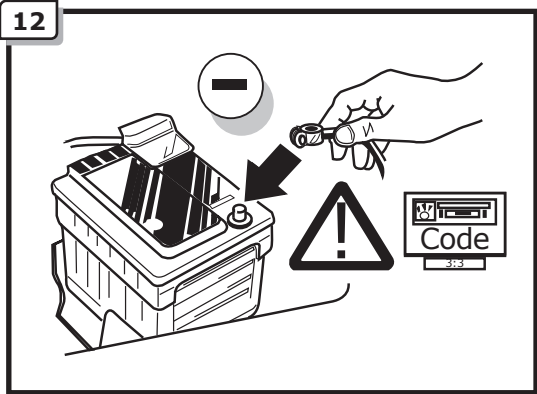

14

! TEST ALL THE CIRCUITS WITH A TEST DEVICE WITH THE CORRECT POWER LOAD FOR EACH FUNCTION. A TEST DEVICE WITH LED'S CANNOT BE USED FOR THIS PURPOSE.

INFO

REINSTALL TRIM.

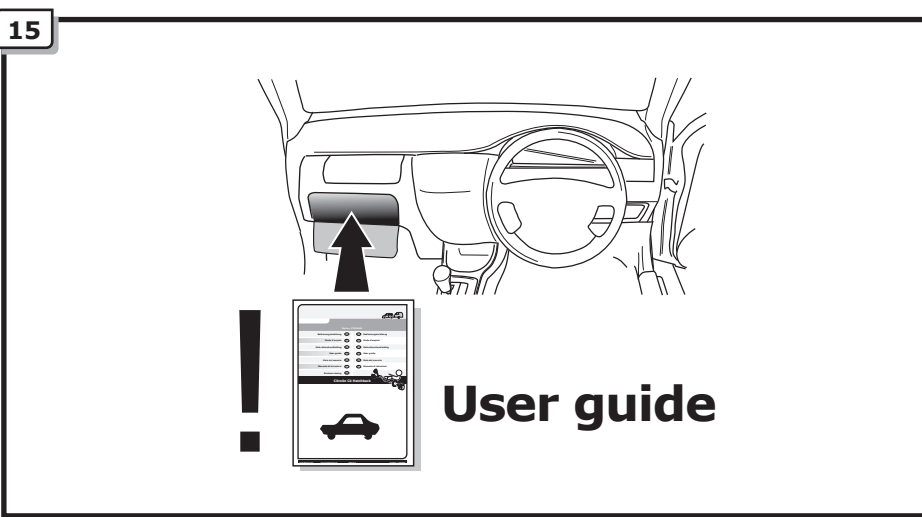

INFO

TECHNICAL SUPPORT

CALL 07440 202 052

ECS ELECTRONICS

MONDAY TO FRIDAY
08.00 - 11.00 am
12.00 - 05.00 pm
t.skinner@ecs-electronics.com
www.ecs-electronicsuk.co.uk









Products & Service

CANfinder®

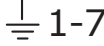
LIGHT MATE®

http://www.ecs-electronics.nl/NL/catalogus/test_gereedschap

SOCKET CONNECTION

DIN/ISO 1724								
	1/L	2	3/31	4/R	5/58-R	6/54	7/58-L	8
Pmax	21W	21W		21W	42W	3x21W	42W	
Colour	Yellow	Blue	White	Green	Brown	Red	Black	Grey

UN-243-YZ Reverse lamp pre-wire extension

⚠ MAX = 21W

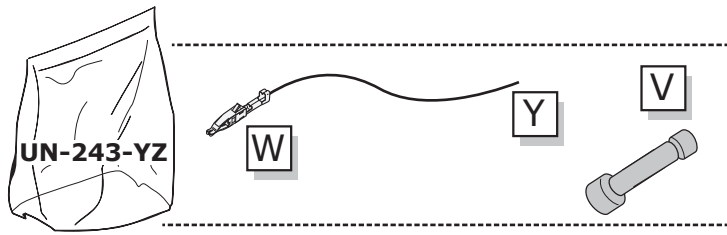

A

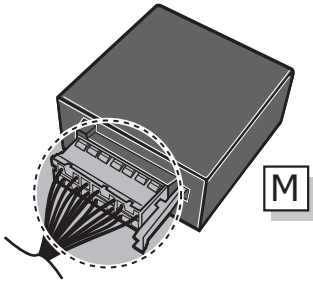

1

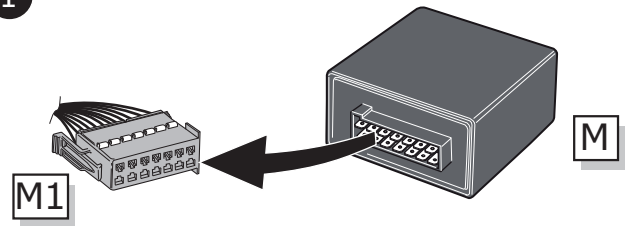

2

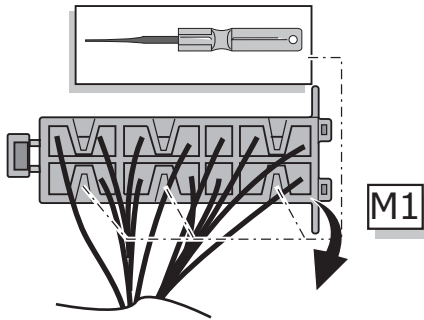

3

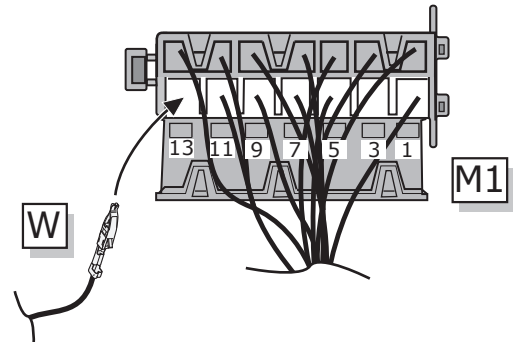

4

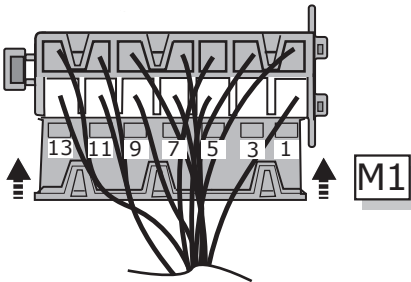

5

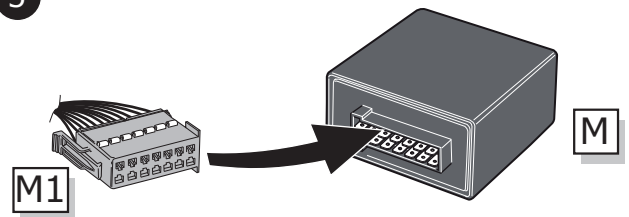

B

⚠ MAX = 21W

