

Jeep Grand Cherokee 05/2013 >>
Jeep Grand Cherokee 2016 >>

Partnr.: CR-066-DHU

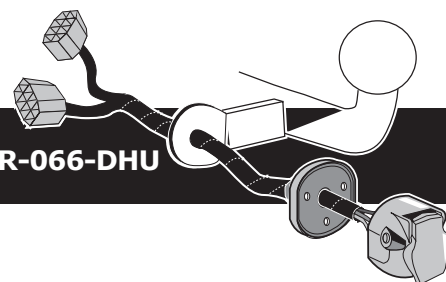

- Fitting instructions electric wiring kit tow bar with 13-P socket up to DIN/ISO Norm 11446.
- We would expressly point out that assembly not carried out properly by a competent installer will result in cancellation of any right to damage compensation, in particular those arising by virtue of the product liability act.
- Contents of these kits and their fitting manuals are subject to alteration without notice, please ensure that these instructions are read and fully understood before commencing installation.
- Do not overload circuits; the maximum loads per connection are detailed in this manual.
- Attention! Before Installation, please read this manual carefully and inform your customer to consult the vehicle owners manual to check for any vehicle modifications required before towing.
- In the event of functional problems, troubleshooting must be limited to about 0.5 hours, contact the technical support:
ukts@ecs-electronics.com / 07440 202 052.



Part list

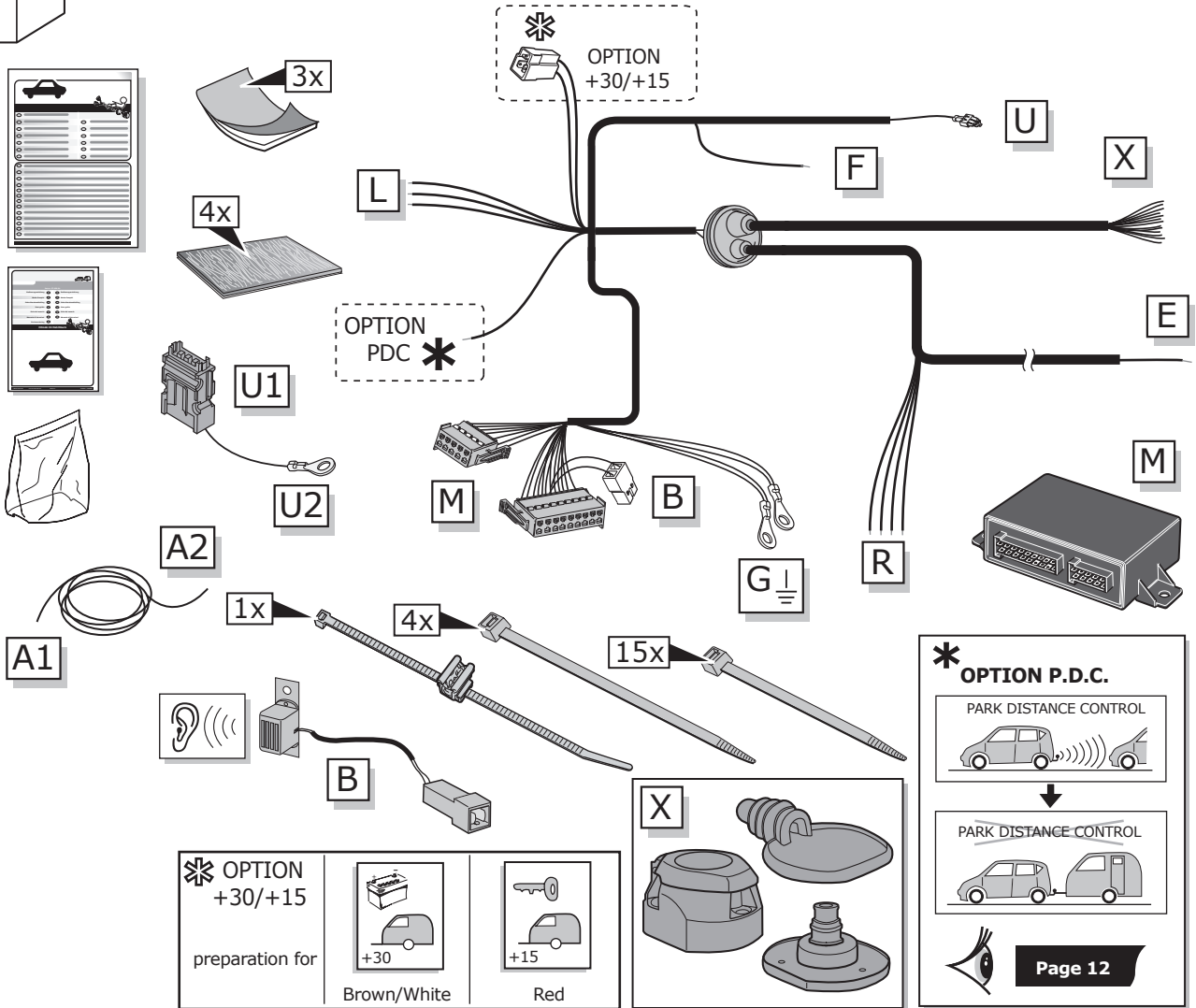
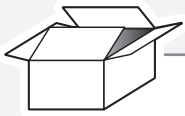

OPTION +30/+15
 preparation for

 +30 Brown/White	 +15 Red
------------------------	----------------

*** OPTION P.D.C.**
 PARK DISTANCE CONTROL

 ↓
 PARK DISTANCE CONTROL

Page 12

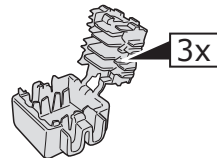
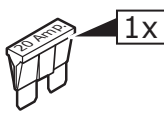
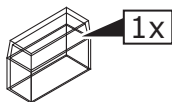
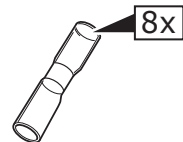
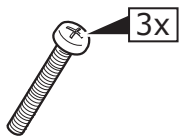

ROUTING

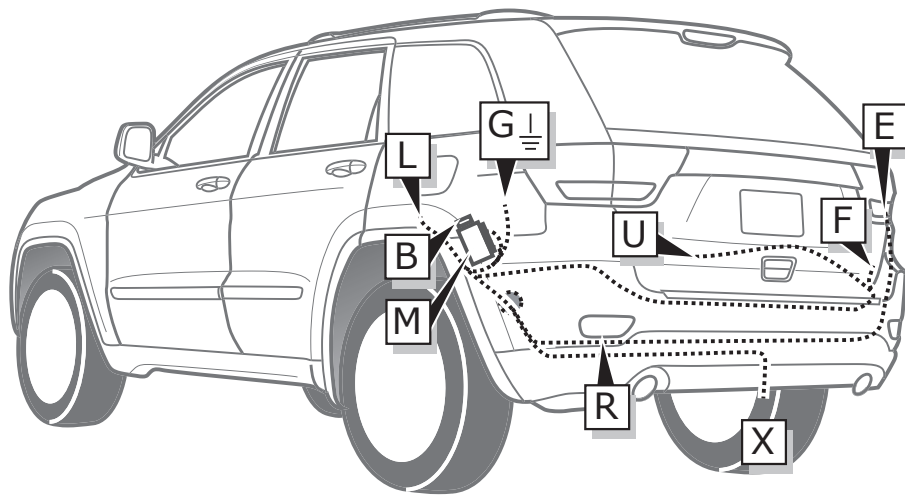

1

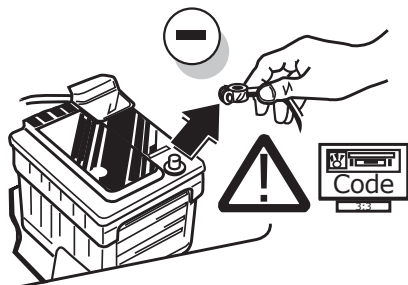

2

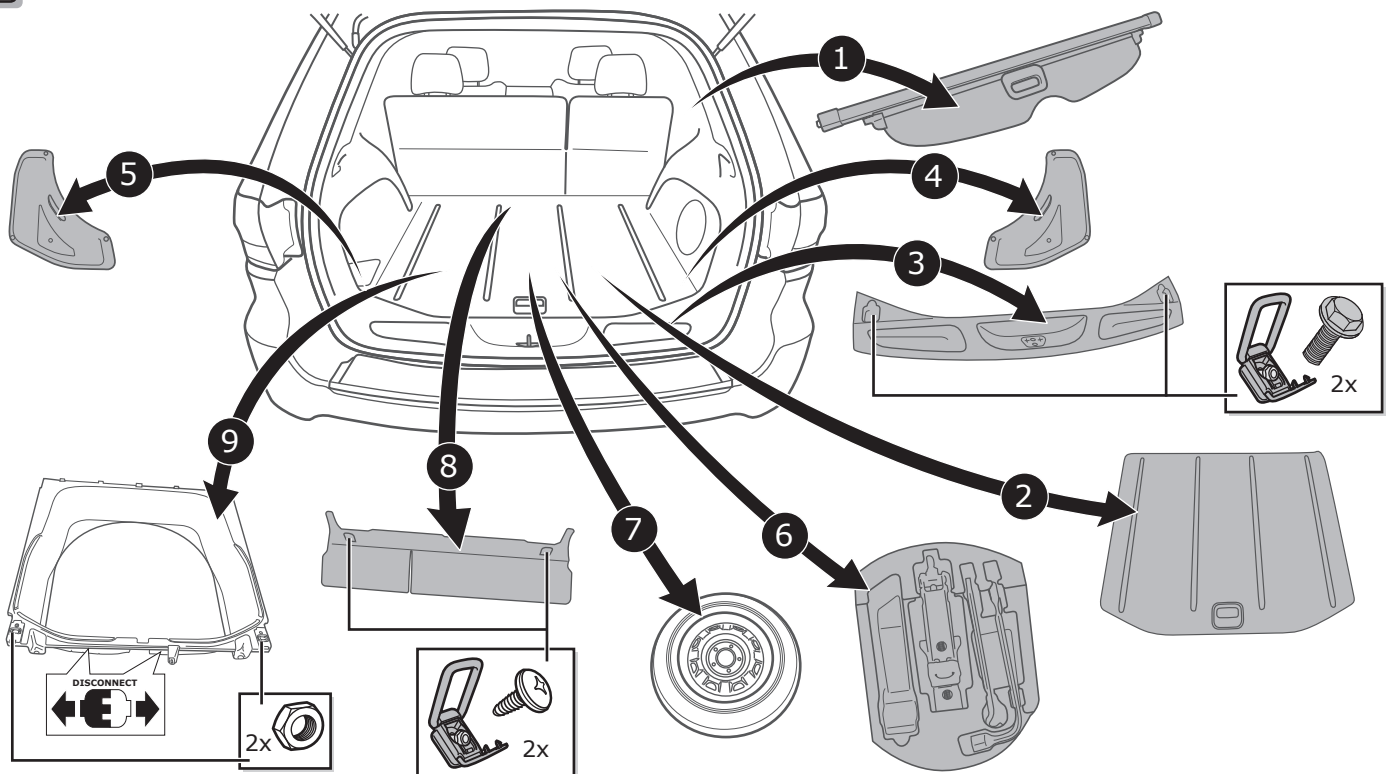

3

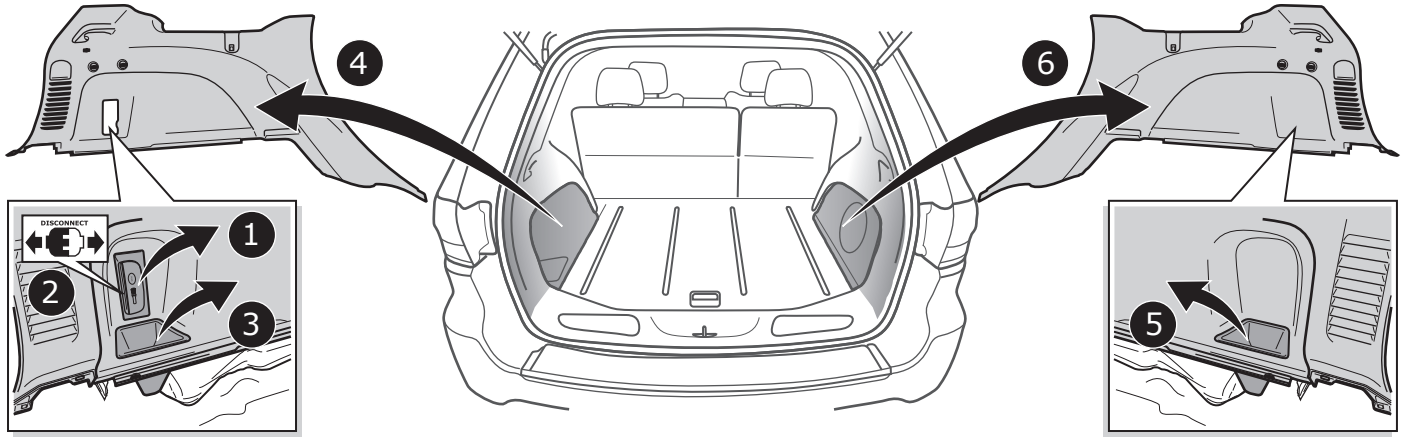

4

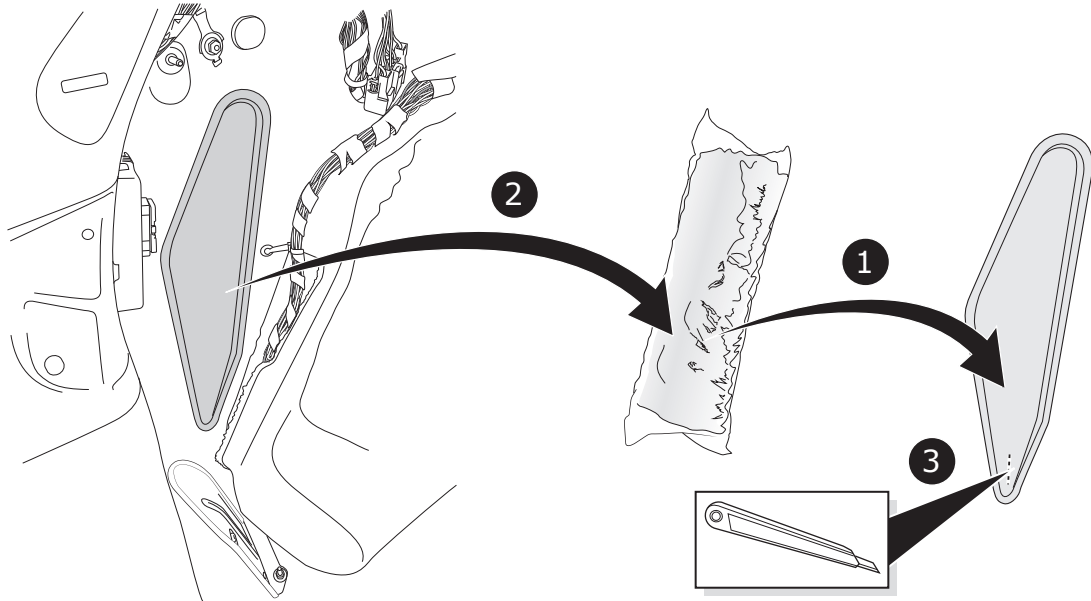

5

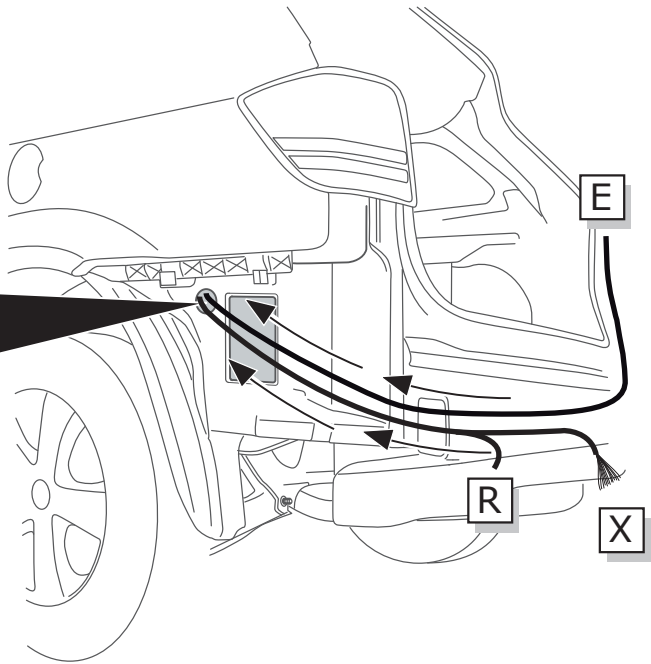
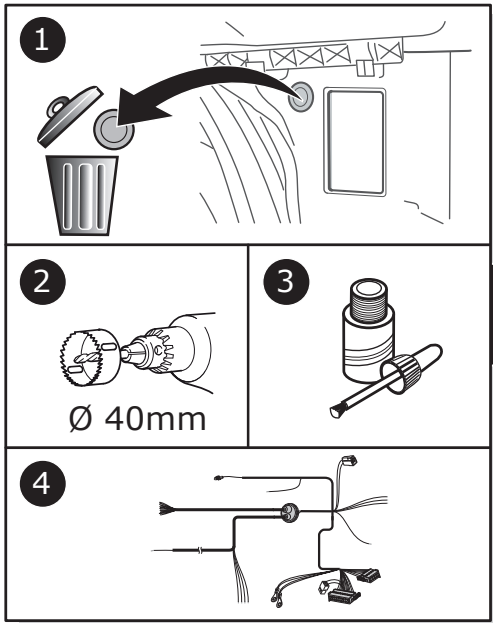

6

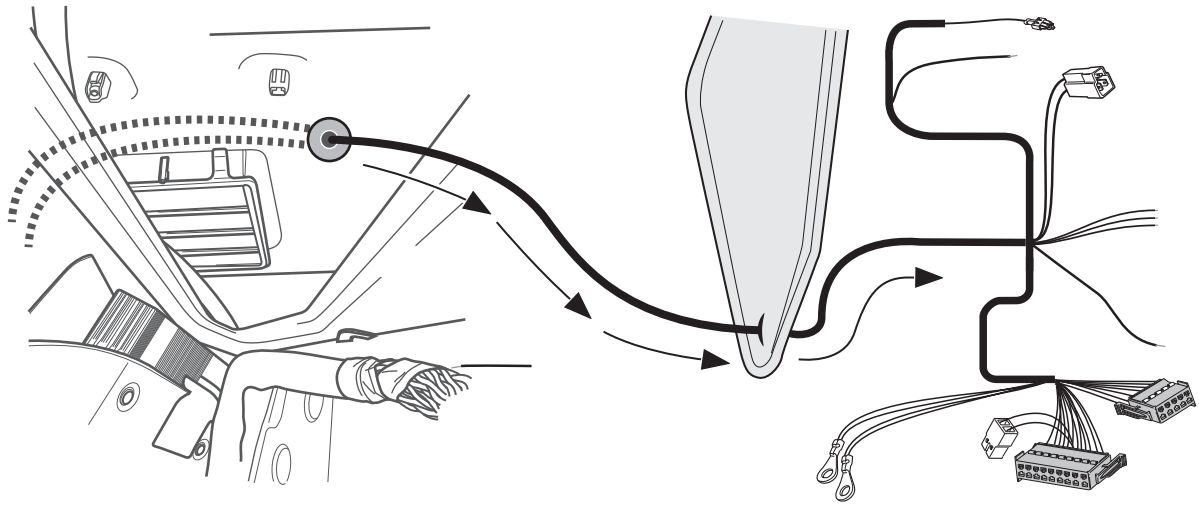

7

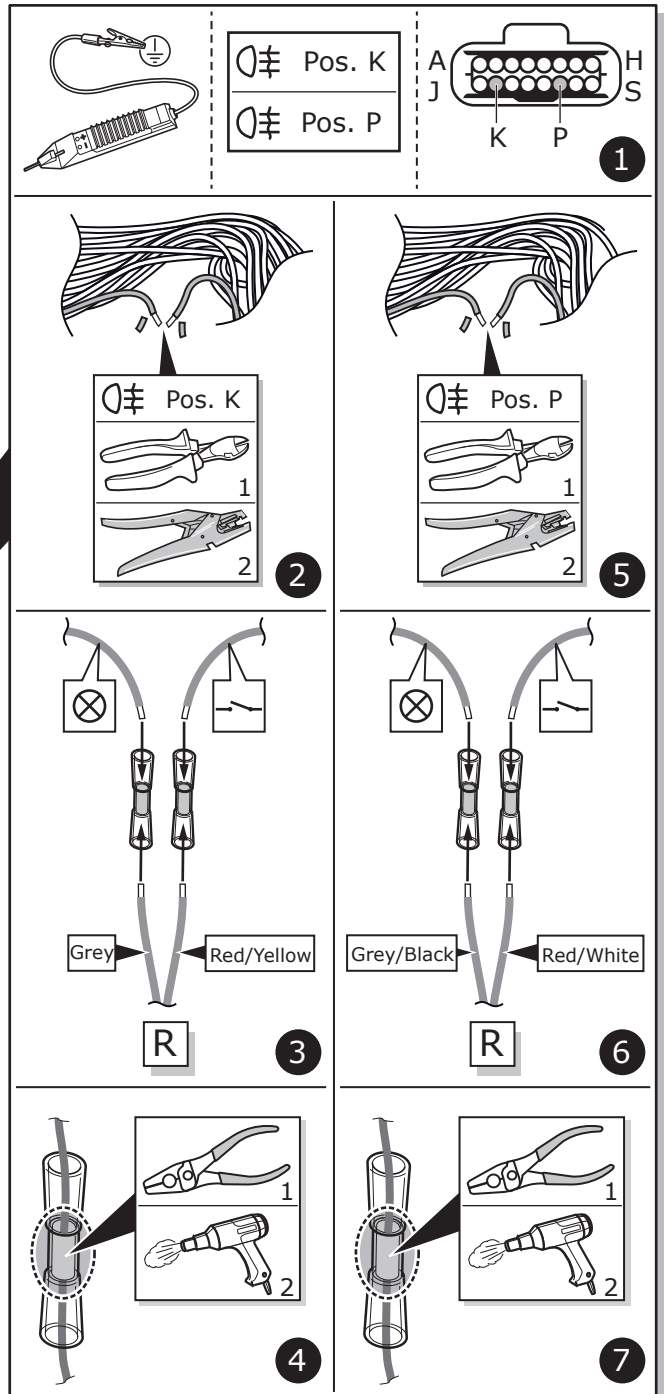
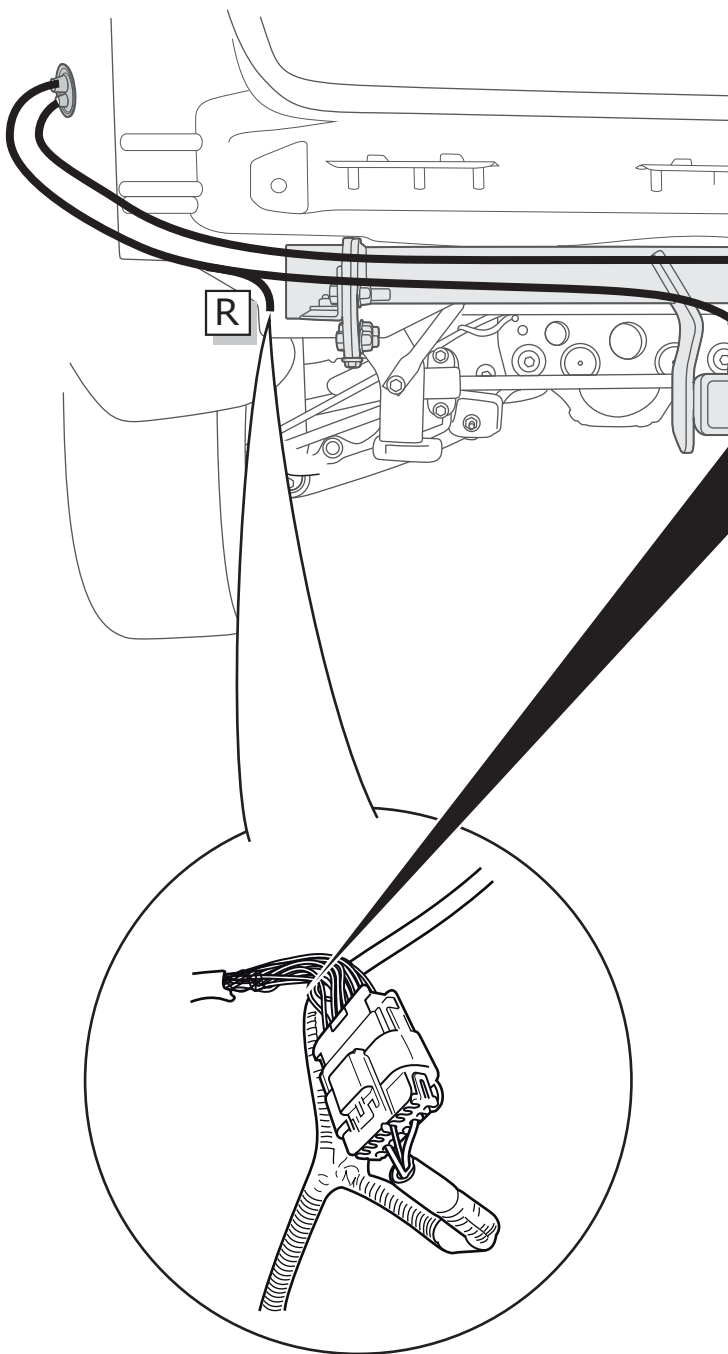

8

4x

E

R

X

1

2

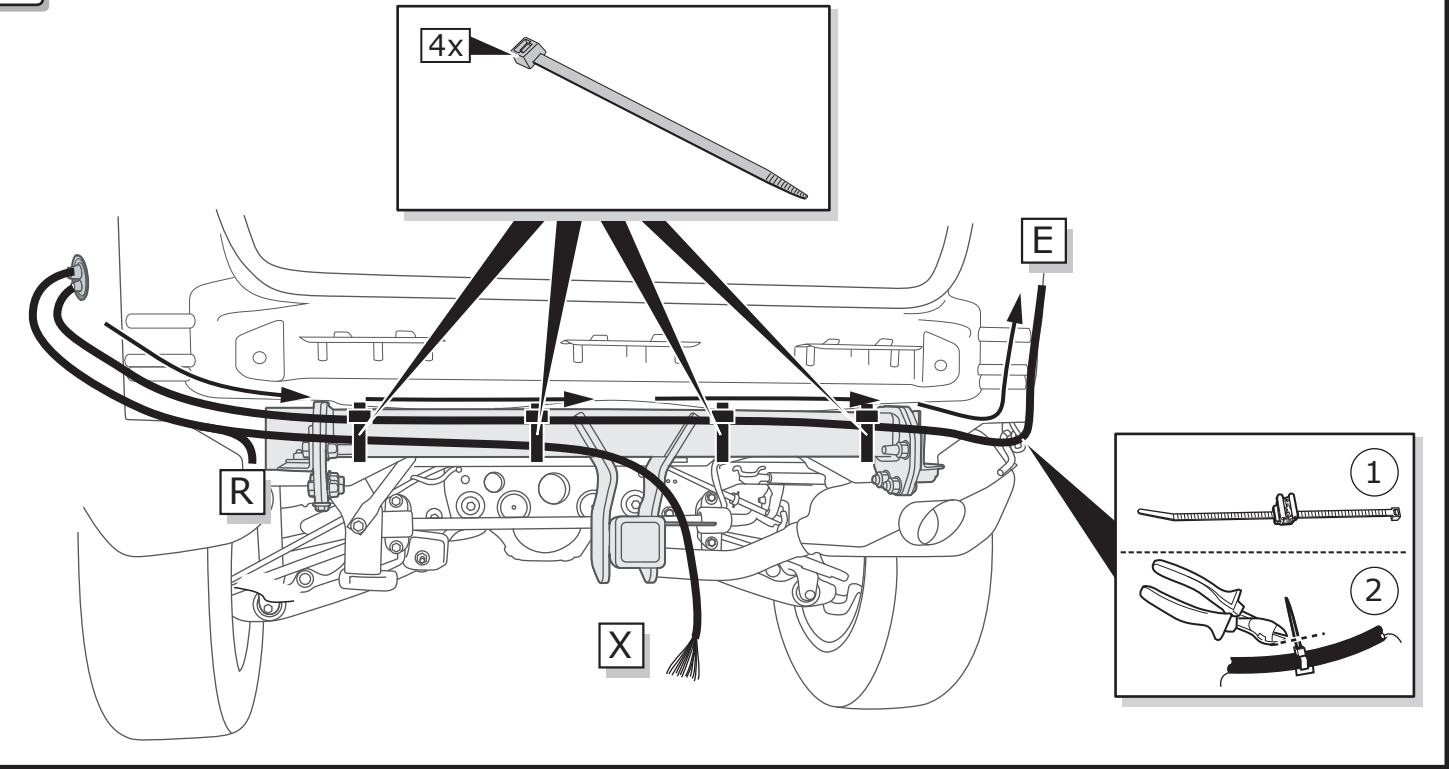

A

Option 1

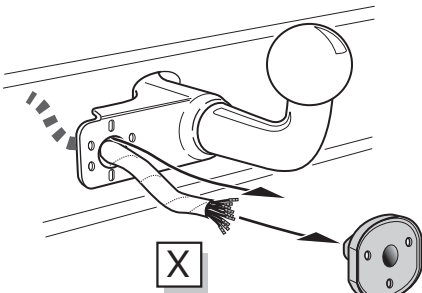

X

Option 2

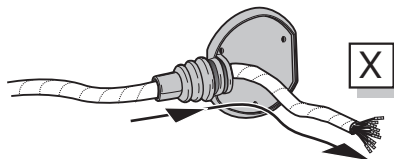

X

Option 3

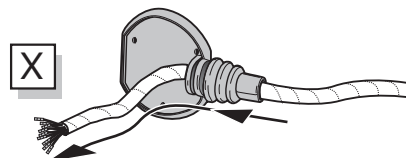

X

INFO

SOCKET CONNECTION



Page 15

B

Option 1

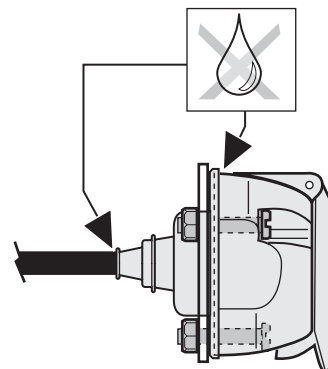
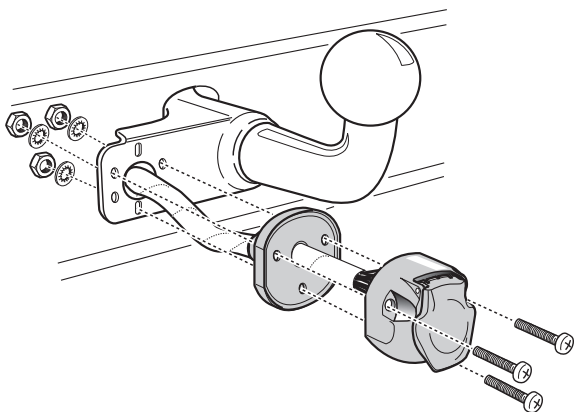

C

Option 2

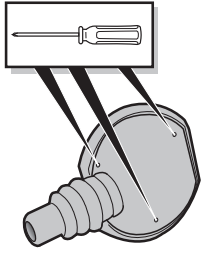

1

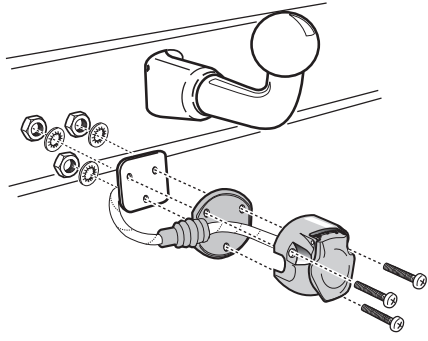

2

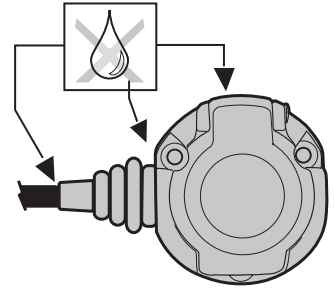

D

Option 3

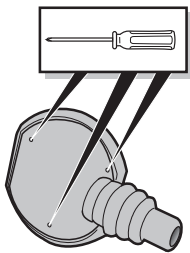

1

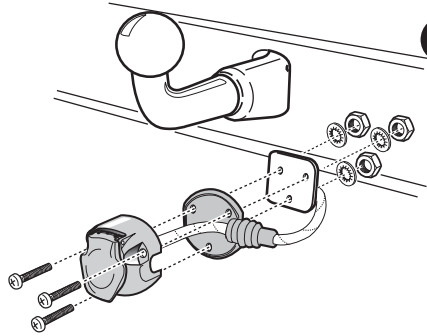

2

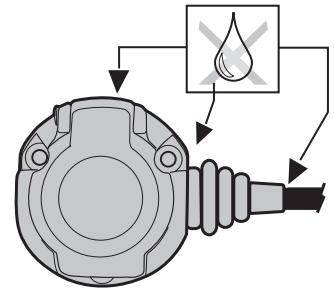

9

JEEP Grand Cherokee
05/2013 >> MY 2015

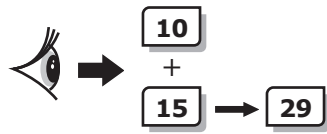

JEEP Grand Cherokee
MY 2016 >>



10

JEEP Grand Cherokee
05/2013 >> MY 2015

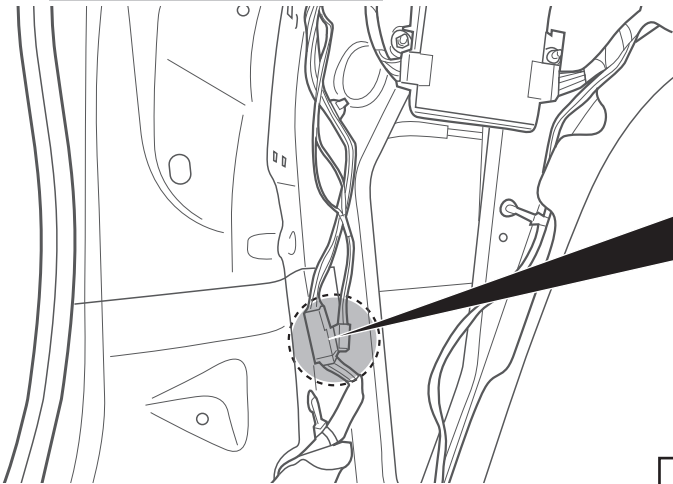

L ←	PIN 3		
L ☀	PIN 11		
L STOP	PIN 5		

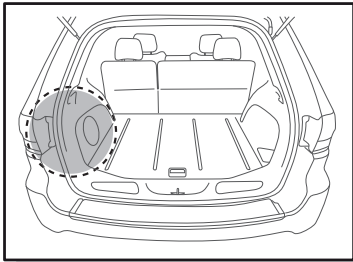

L	Black/Yellow	→ ←	L ←
	Purple/Black	→ ←	L ☀
	Blue/Red	→ ←	L STOP

1. Connect the wires to the connector.
2. Push the connector into the tail light housing.
3. Trim the excess wire with wire cutters.
4. Crimp the wires with crimping pliers.

11

JEEP Grand Cherokee
MY 2016 >>

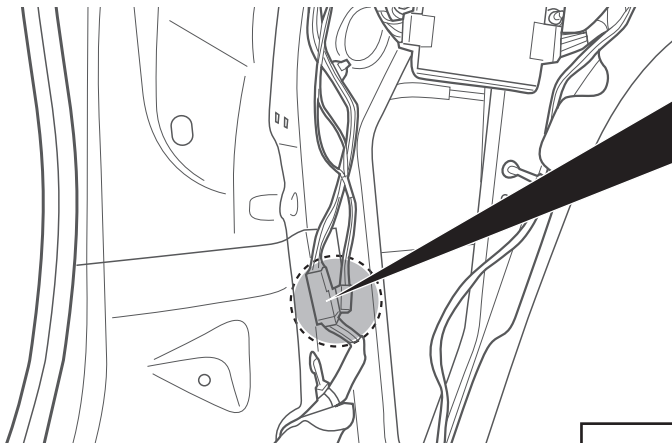

L ☀	PIN 11		
L STOP	PIN 5		

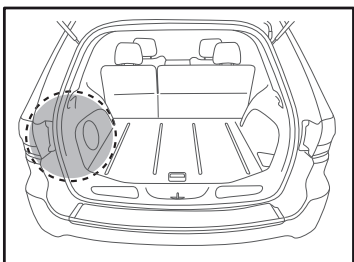

L	Black/Yellow	→ ←	L ←
	Purple/Black	→ ←	L ☀
	Blue/Red	→ ←	L STOP

1. Connect the wires to the connector.
2. Push the connector into the tail light housing.
3. Trim the excess wire with wire cutters.
4. Crimp the wires with crimping pliers.

12 JEEP Grand Cherokee MY 2016 >>

1

2

3

13 JEEP Grand Cherokee MY 2016 >>

14 JEEP Grand Cherokee MY 2016 >>

15

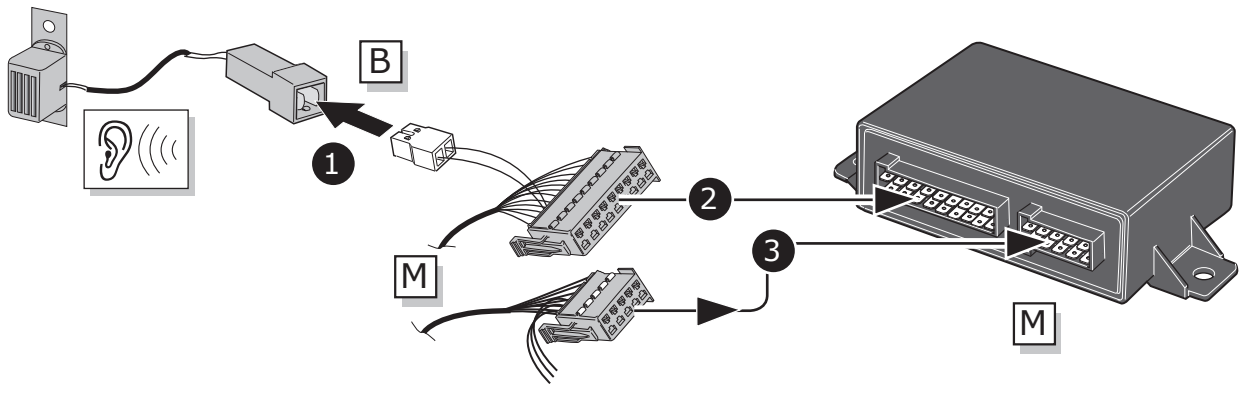

16

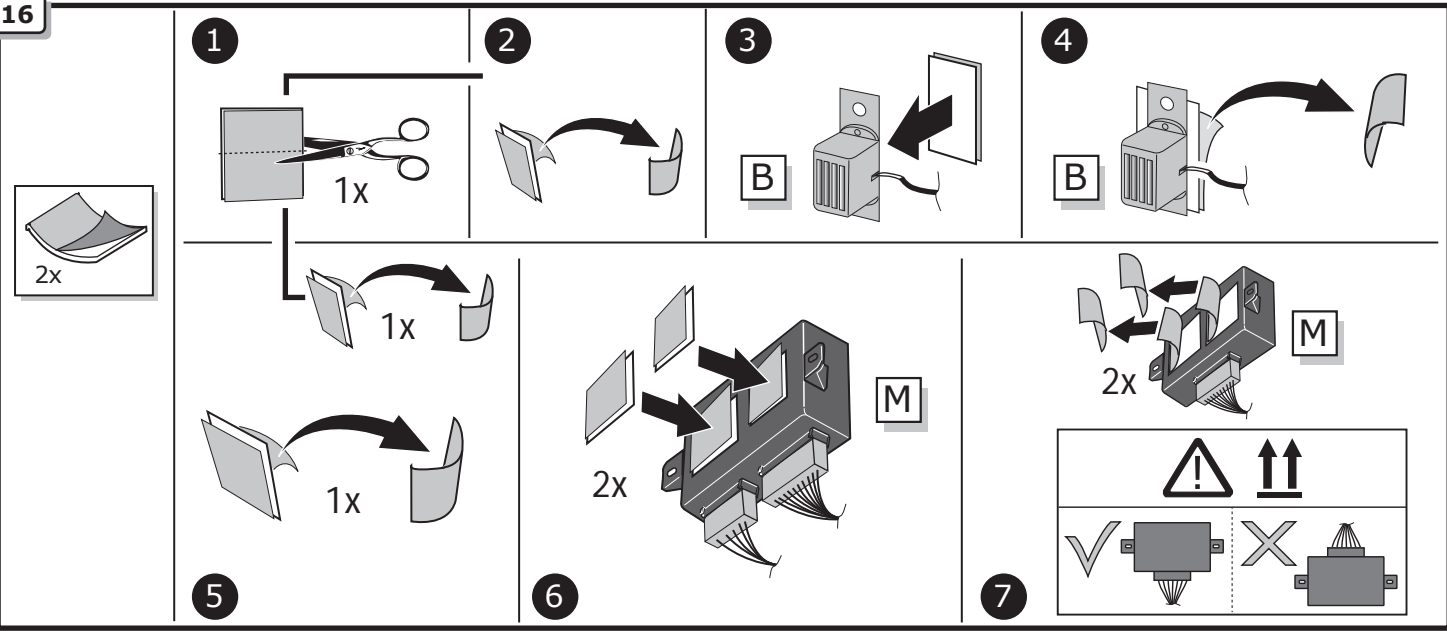

17

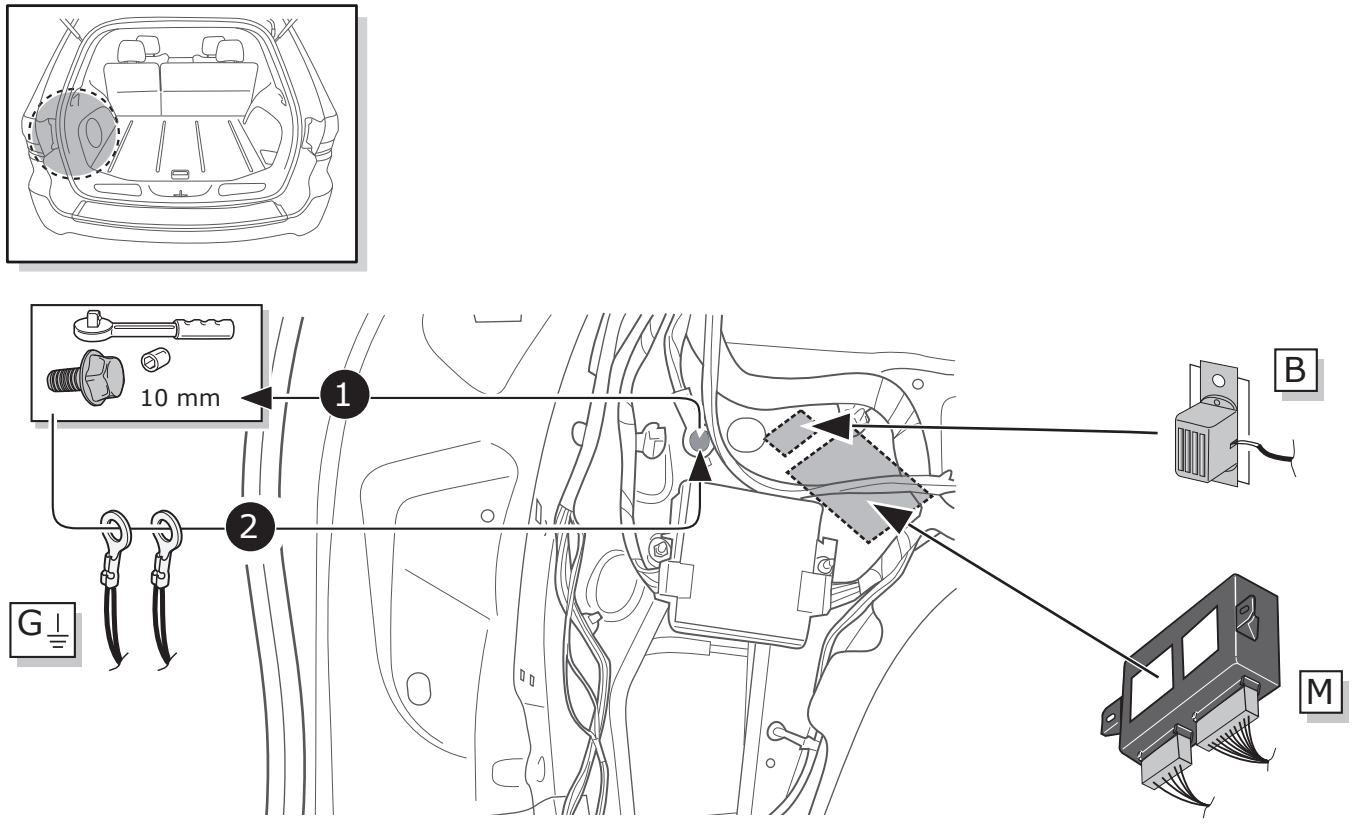

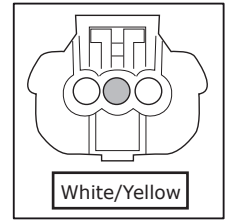
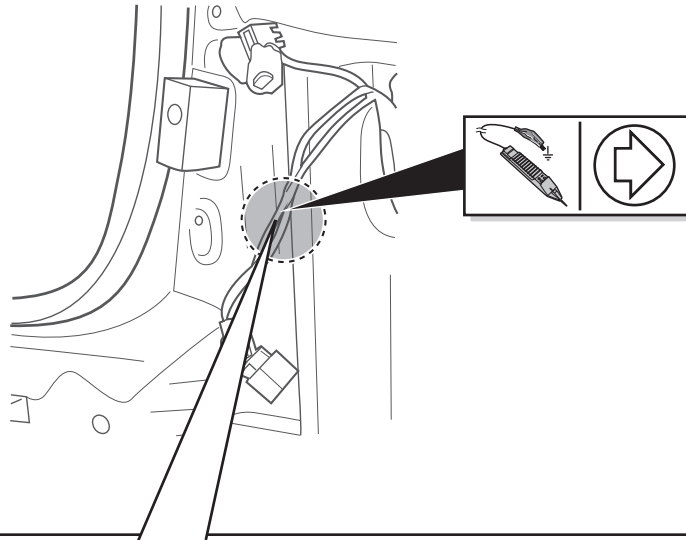
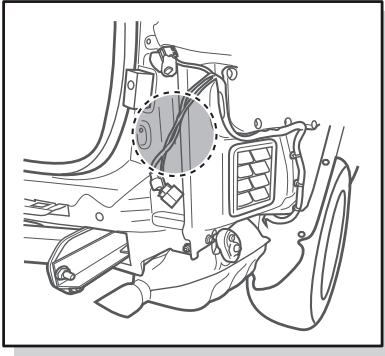

1

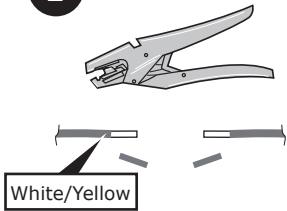

2

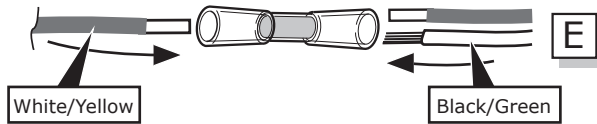

3

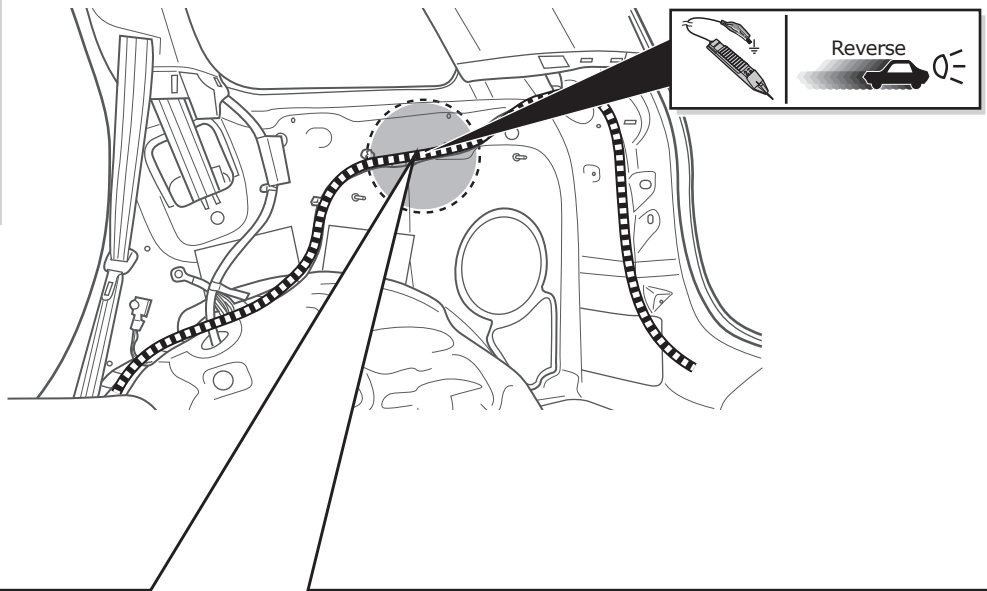
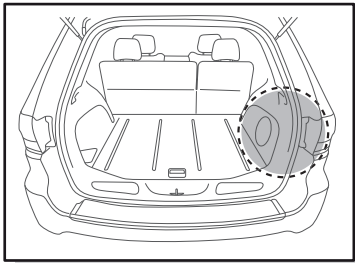
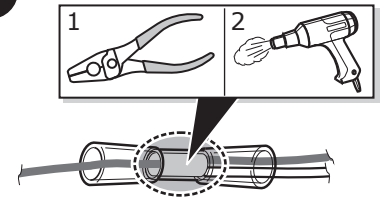

1

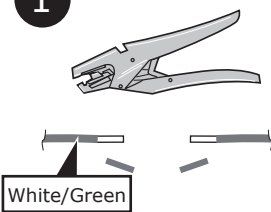

2

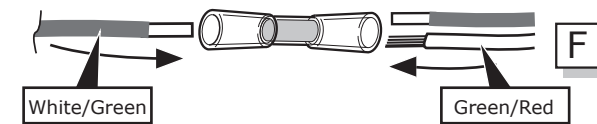

3

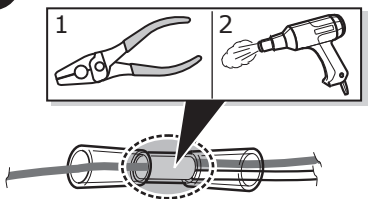

Option 1: Vehicles with Factory-Fitted PDC-System

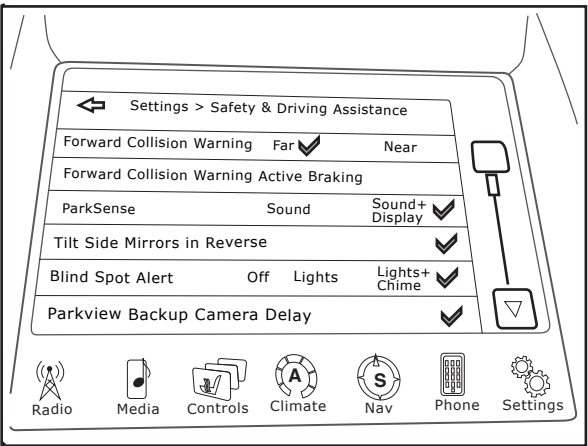
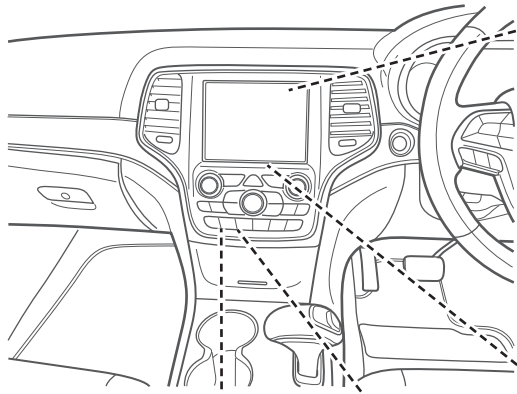

➔ Press "PDC OFF"

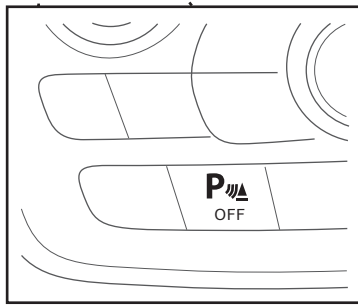

- ➔ Touchscreen Modus "Settings"
- ➔ Selection "Safety and Driving Assistance"
- ➔ Blind Spot Alert "Lights+Chime" ✓

Option 2: Vehicles with MOPAR PDC-System

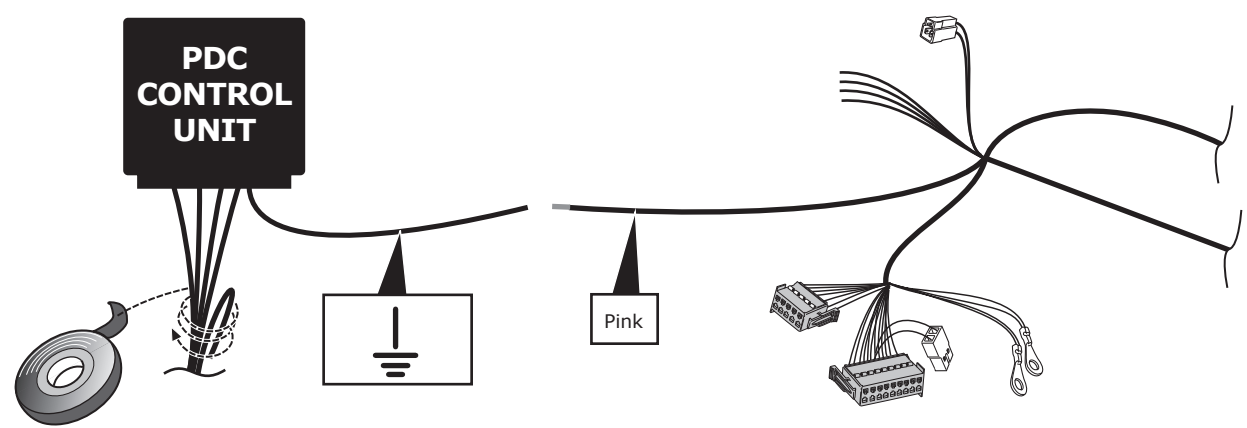
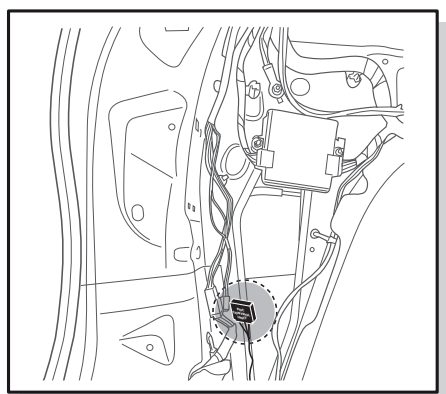
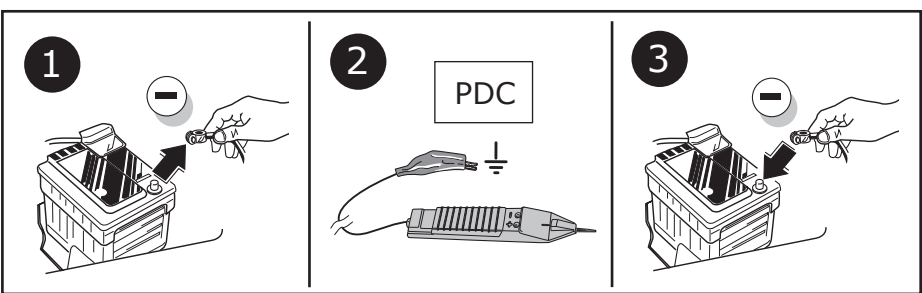

22

Option 3: Vehicles with MOPAR PDC-System

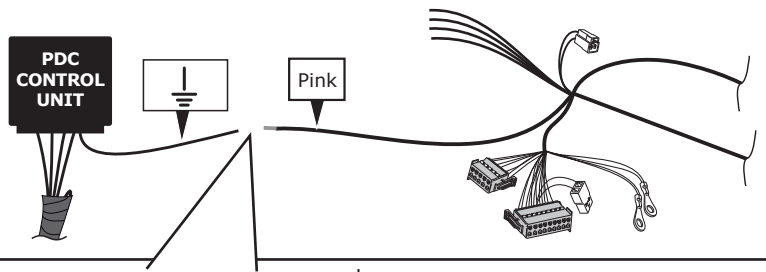

1

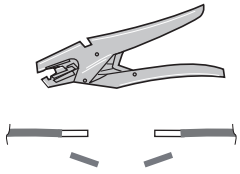

2

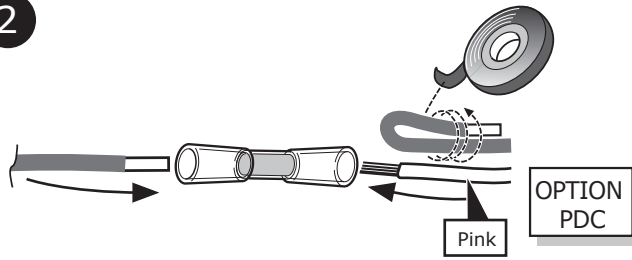

3

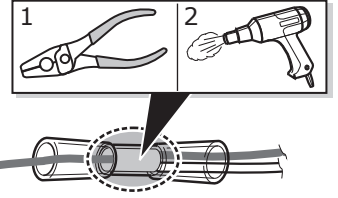

23

Option 4: Vehicles without PDC-System

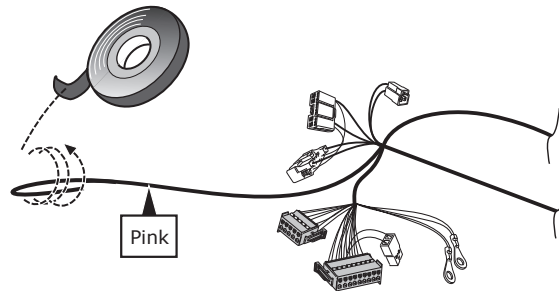
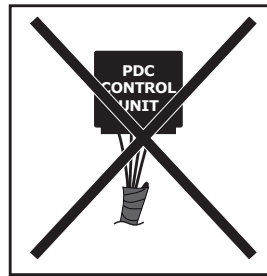

24

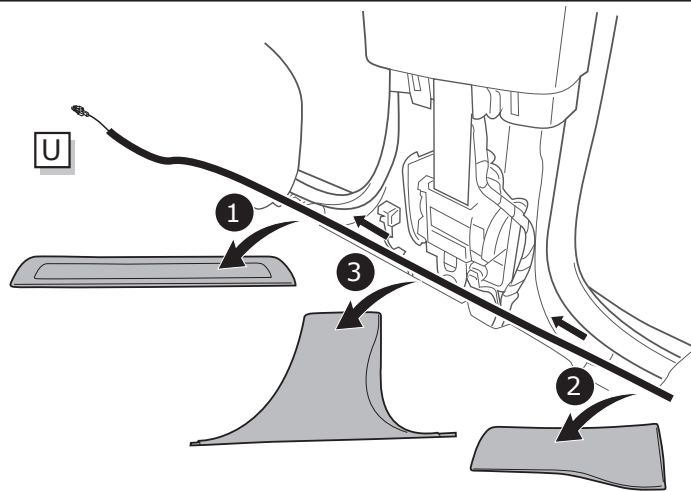
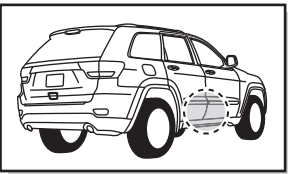

25

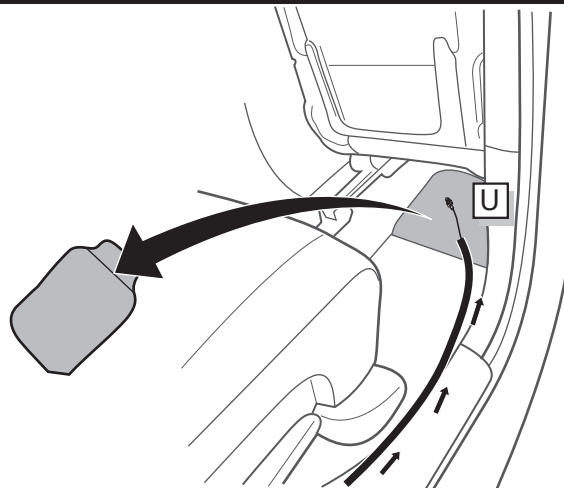
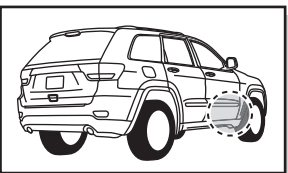

26

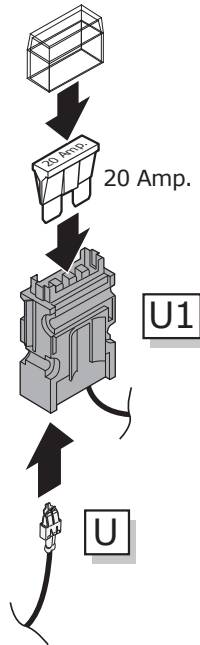

27

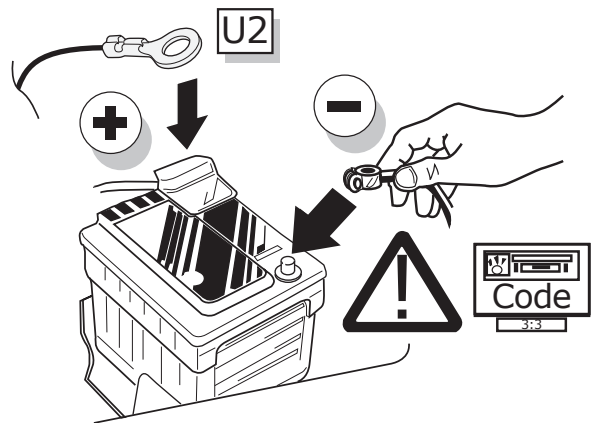
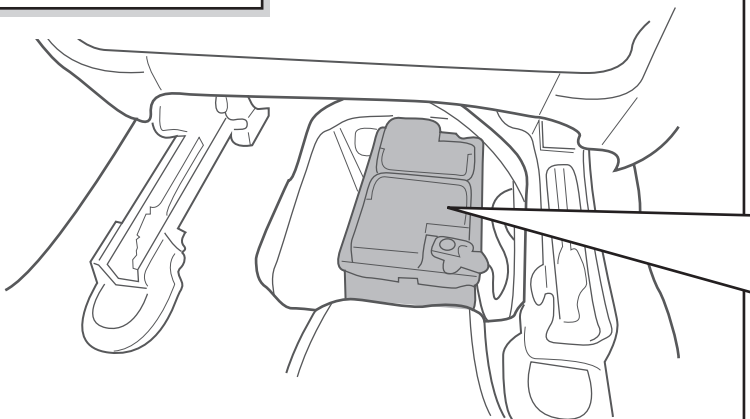
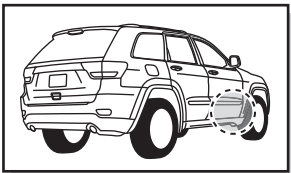

28



TEST ALL THE CIRCUITS WITH A TEST DEVICE WITH THE CORRECT POWER LOAD FOR EACH FUNCTION. A TEST DEVICE WITH LED'S CANNOT BE USED FOR THIS PURPOSE.

INFO

REINSTALL TRIM.

29

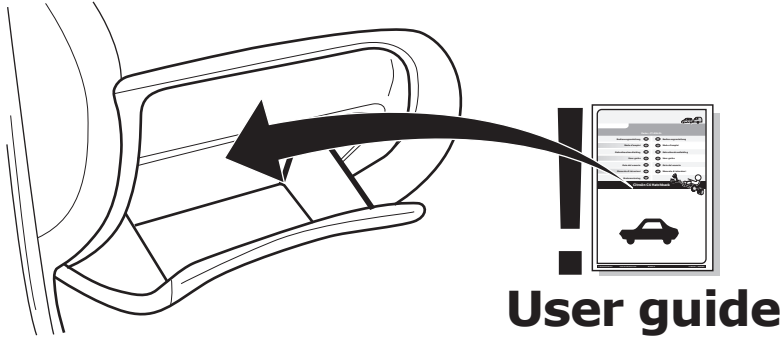

INFO

SOCKET CONNECTION

DIN/ISO 11446													
	1/L	2	3/31	4/R	5/58-R	6/54	7/58-L	8	9	10	11	12	13
Pmax	21W	2x21W		21W	52W	3x21W	52W	2x21W	180W/15Amp	180W/15Amp			
Colour	Yellow	Blue	White	Green	Brown	Red 1,00 mm ²	Black	Black/ Red	Brown/ White	Red 2,50 mm ²	White	-	White