

**Ford Kuga 05/2008 >>**

**Partnr.: FR-040-BHU**

- Fitting instructions electric wiring kit tow bar with 12-N socket up to DIN/ISO Norm 1724.
- We would expressly point out that assembly not carried out properly by a competent installer will result in cancellation of any right to damage compensation, in particular those arising by virtue of the product liability act.
- Contents of these kits and their fitting manuals are subject to alteration without notice, please ensure that these instructions are read and fully understood before commencing installation.
- Do not overload circuits; the maximum loads per connection are detailed in this manual.
- Attention! Before Installation, please read this manual carefully and inform your customer to consult the vehicle owners manual to check for any vehicle modifications required before towing.
- In the event of functional problems, troubleshooting must be limited to about 0.5 hours, contact the technical support:  
[ukts@ecs-electronics.com](mailto:ukts@ecs-electronics.com) / 07440 202 052.



# Part list

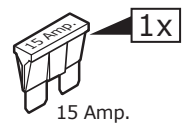
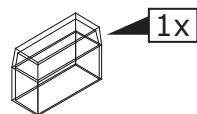
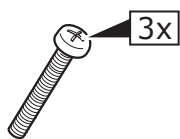
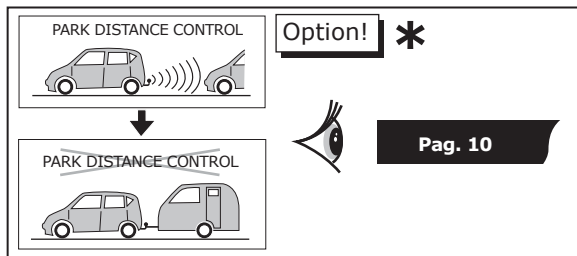
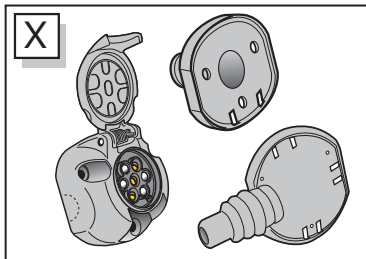
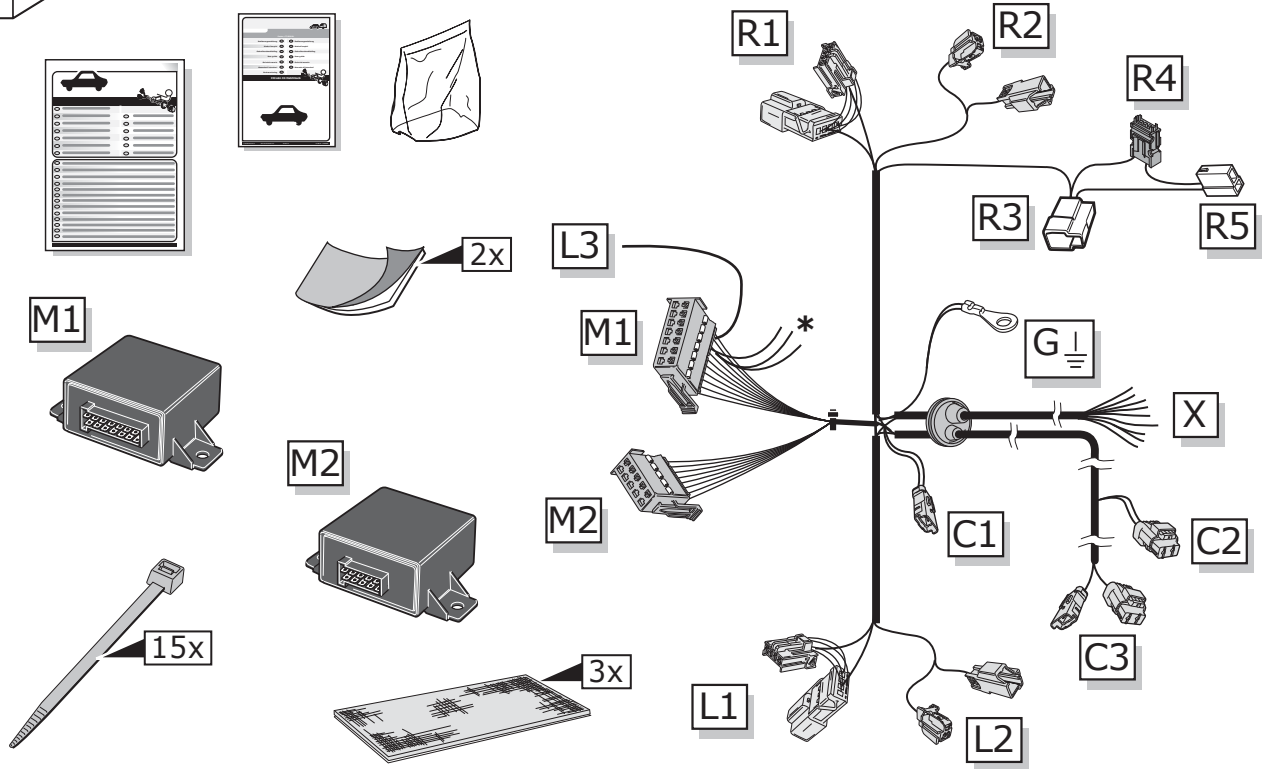
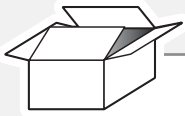

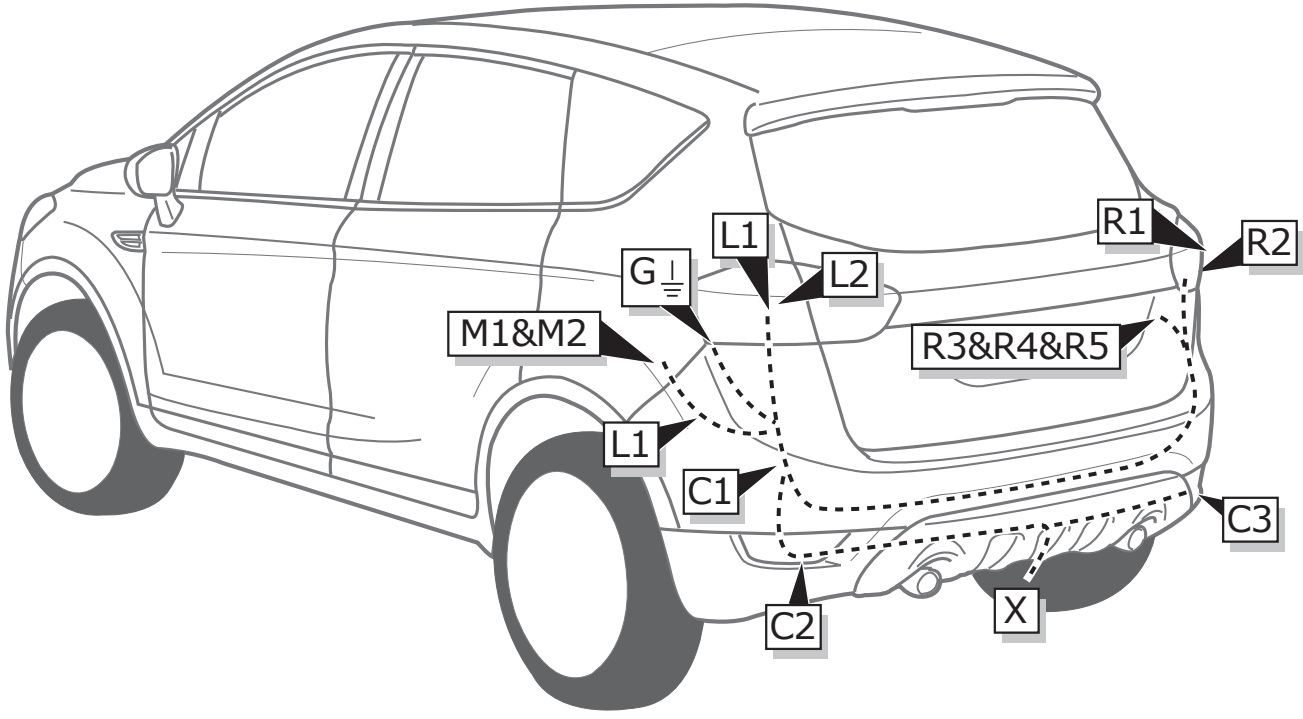

1

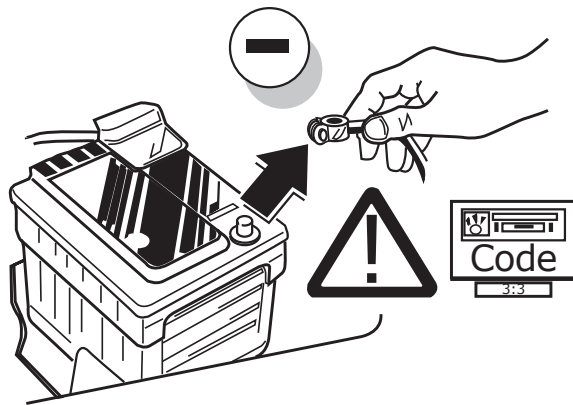

2

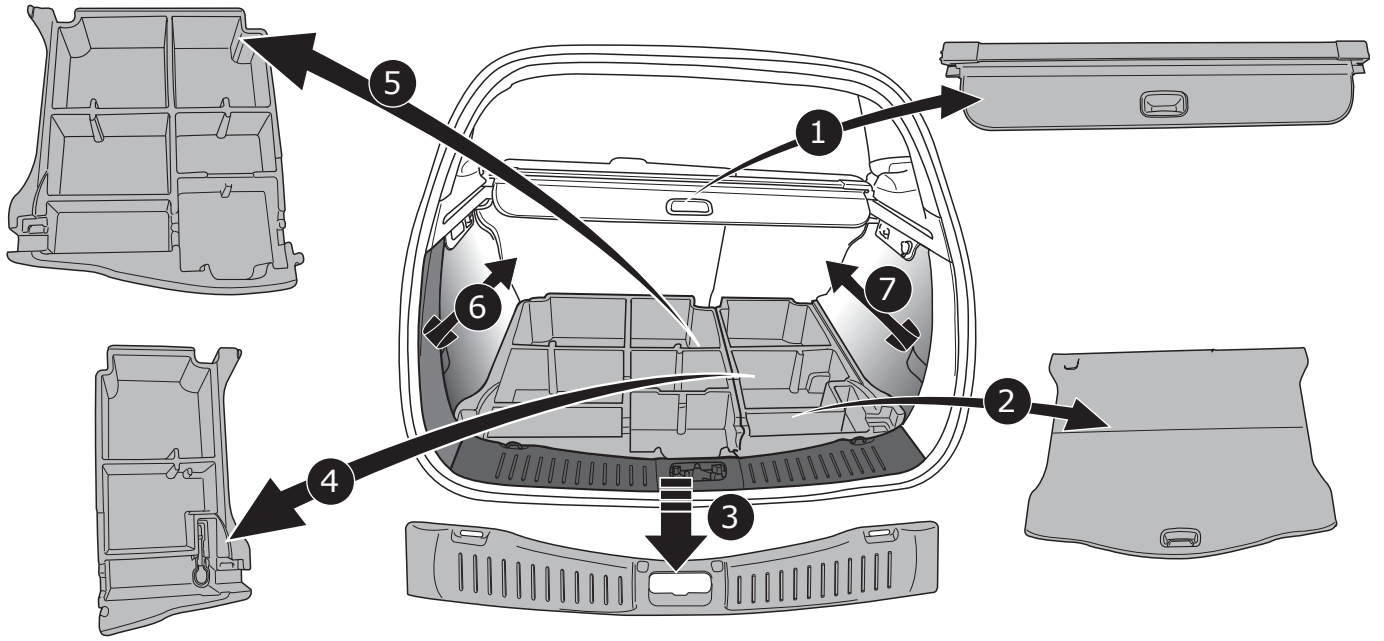

3

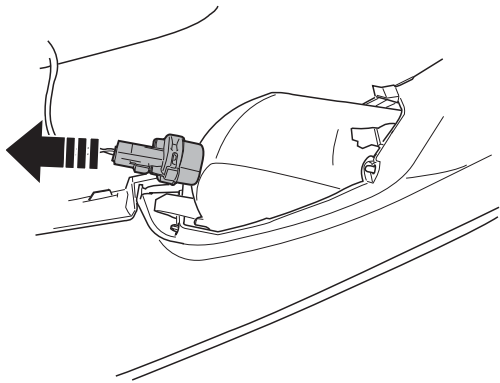
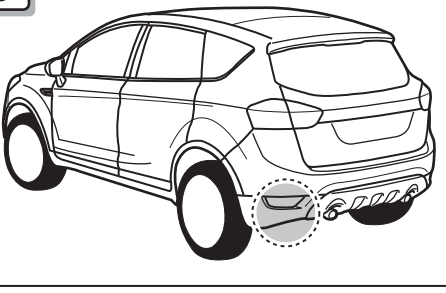

4

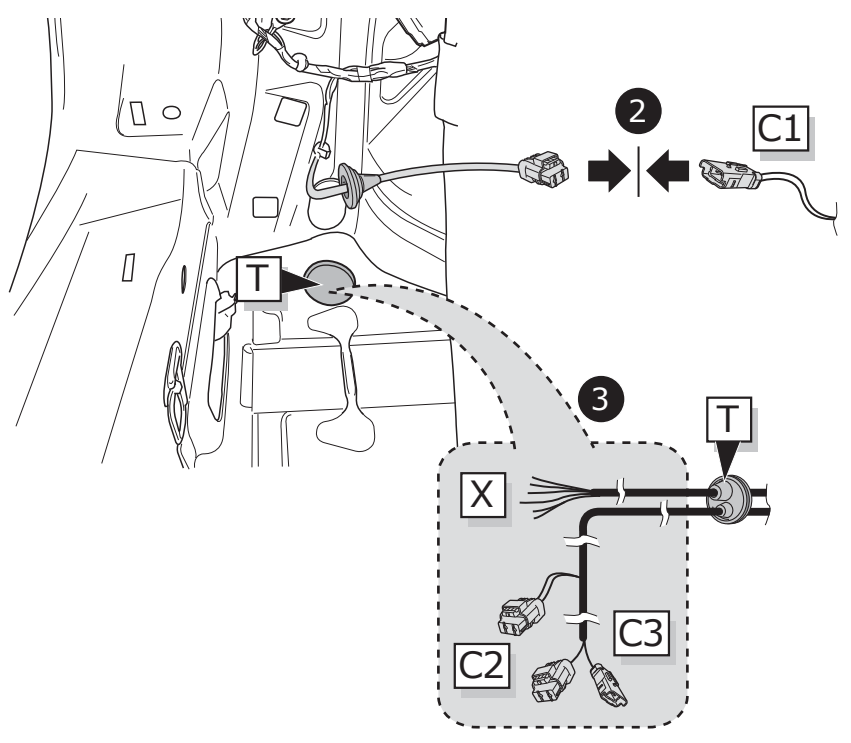
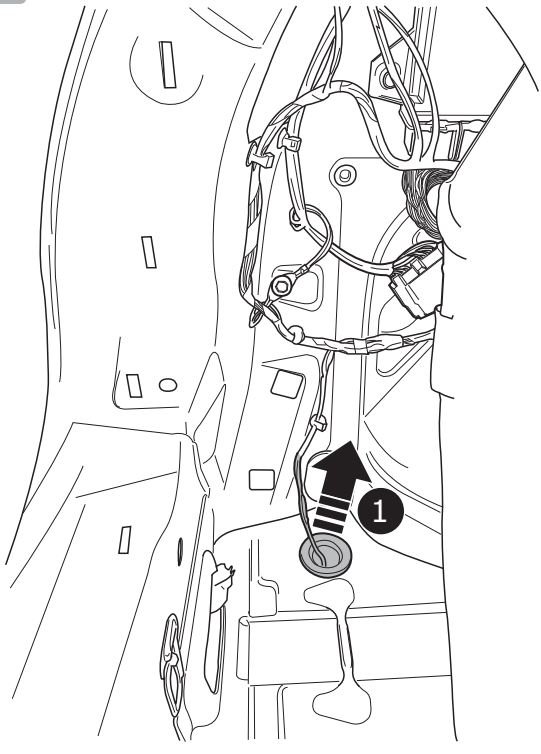

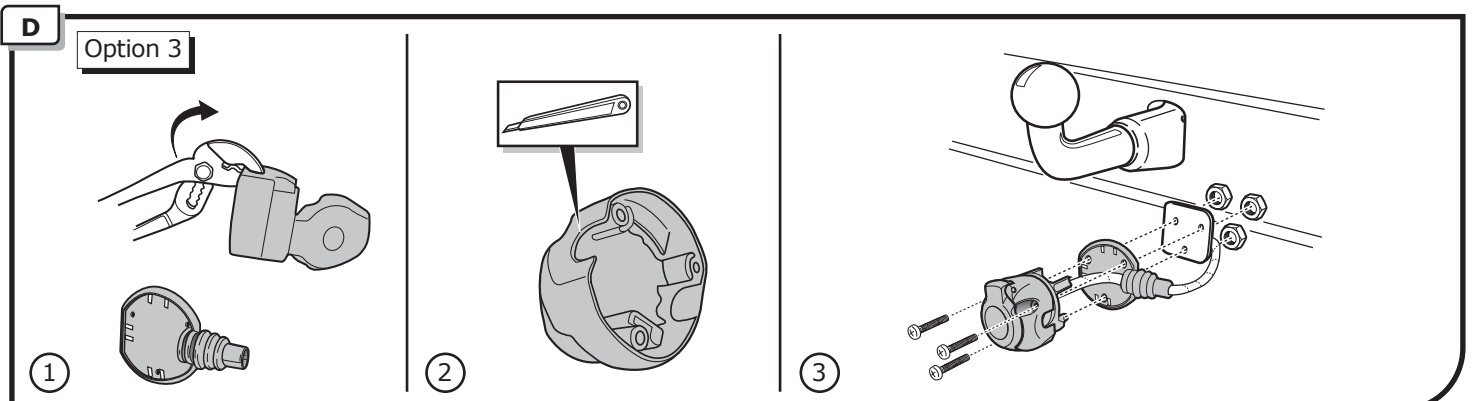
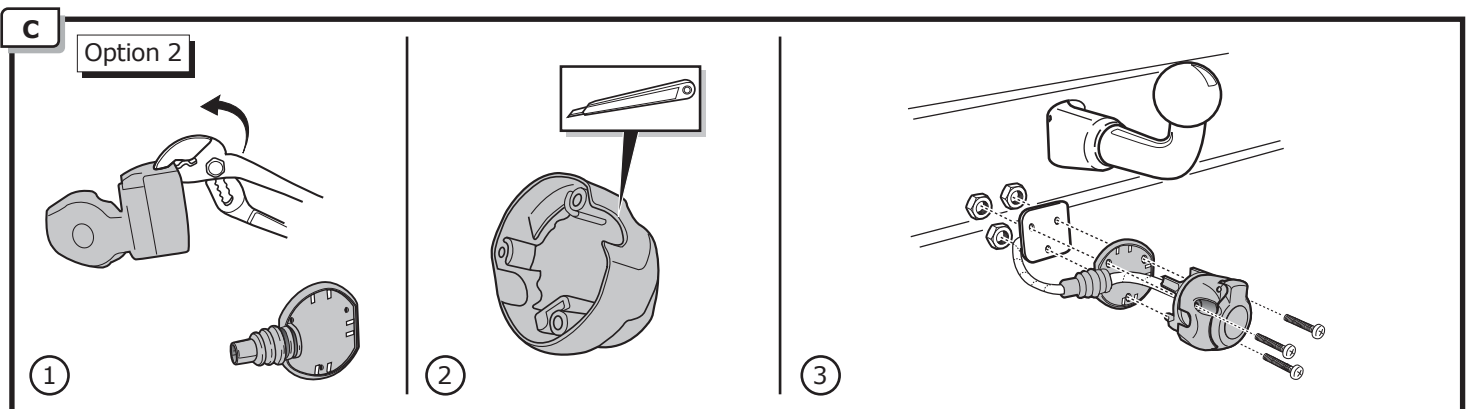
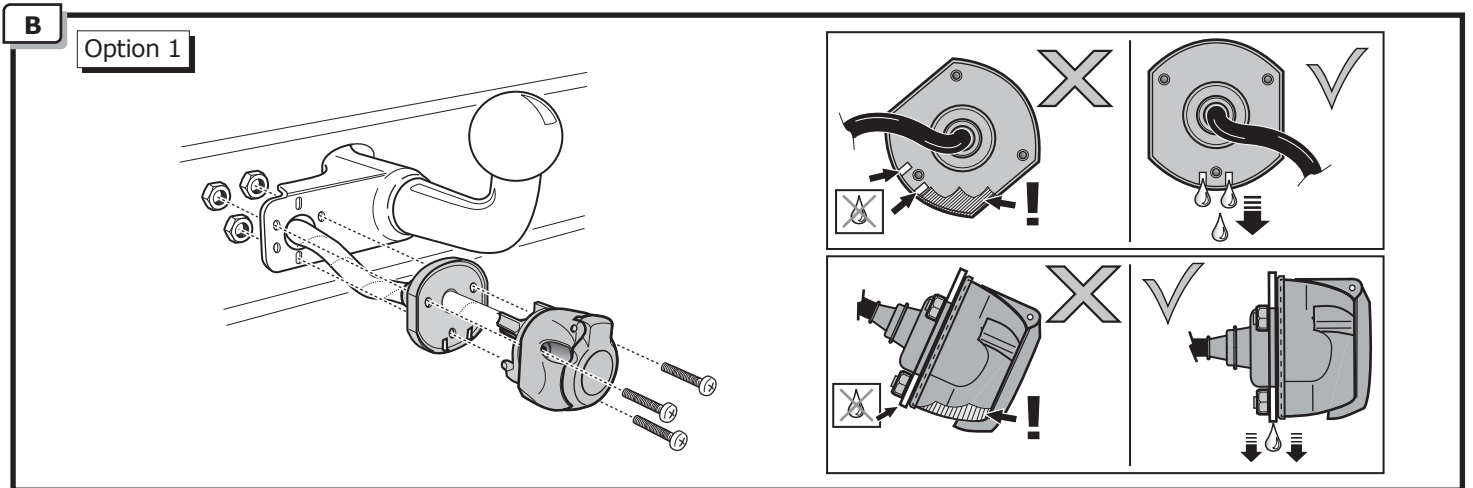
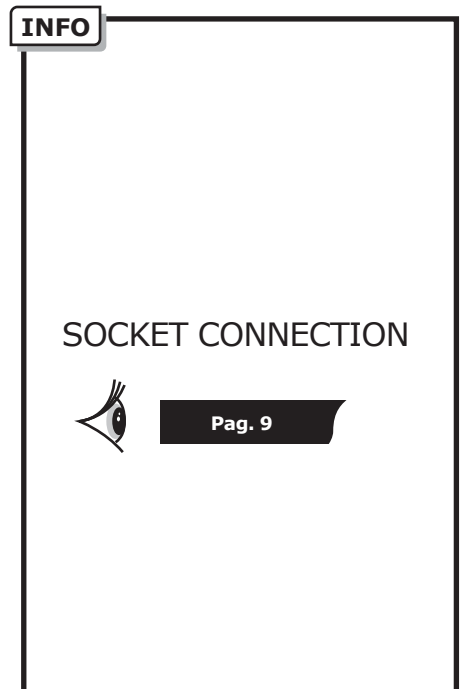
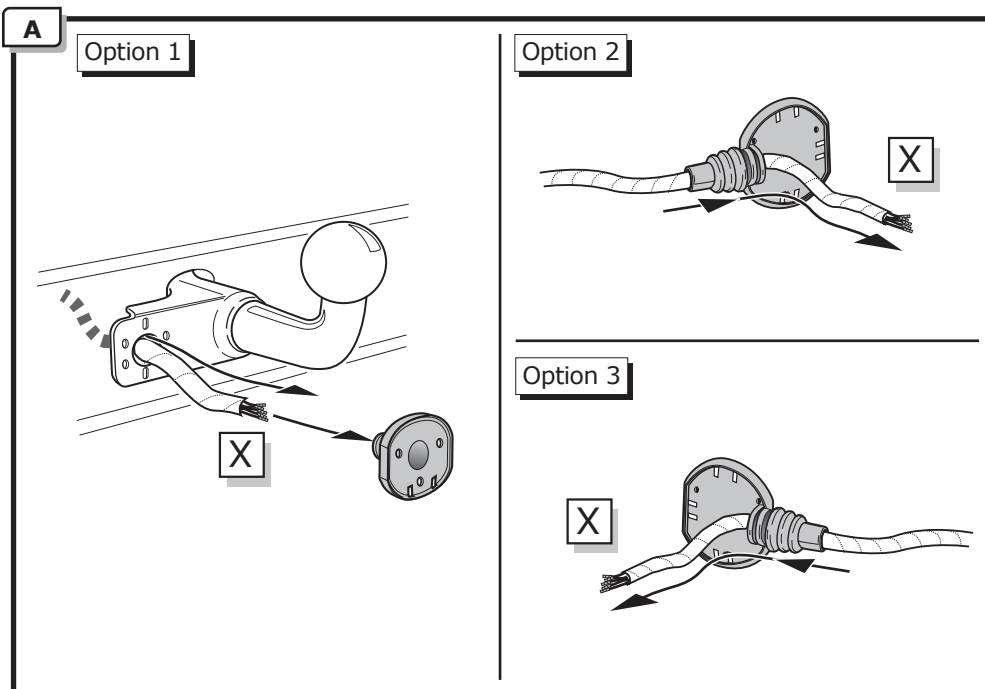

5

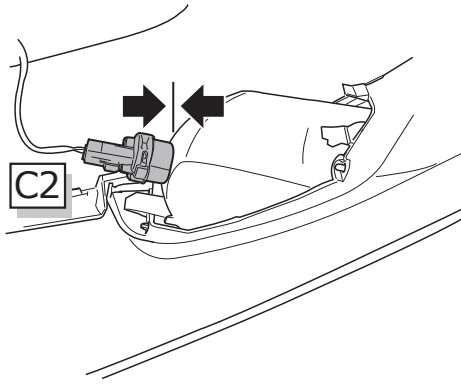
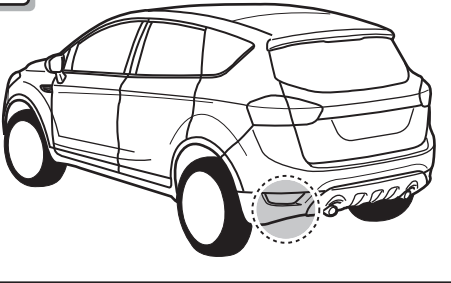

6

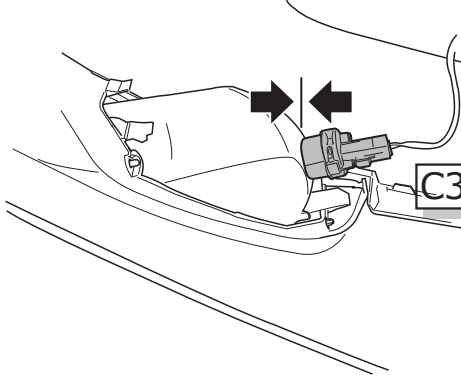
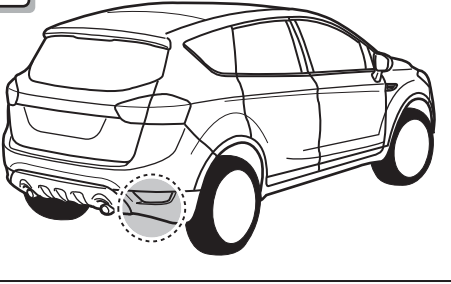

7

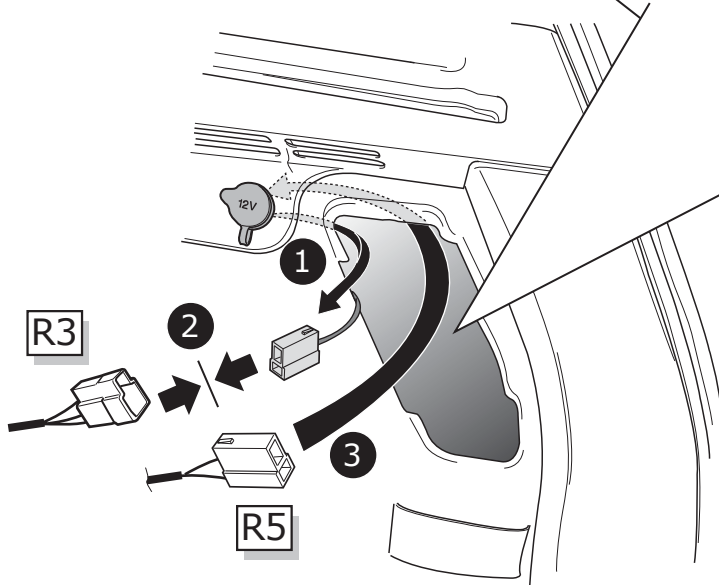
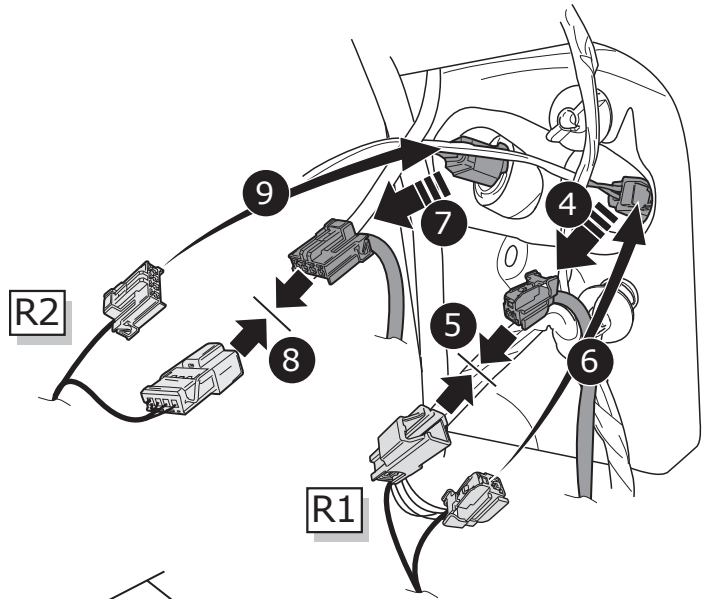
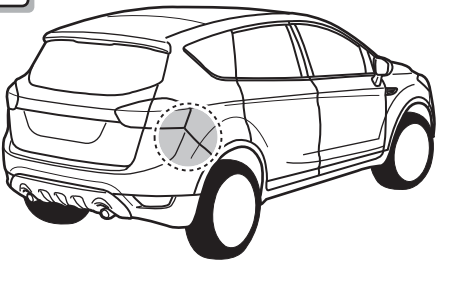

8

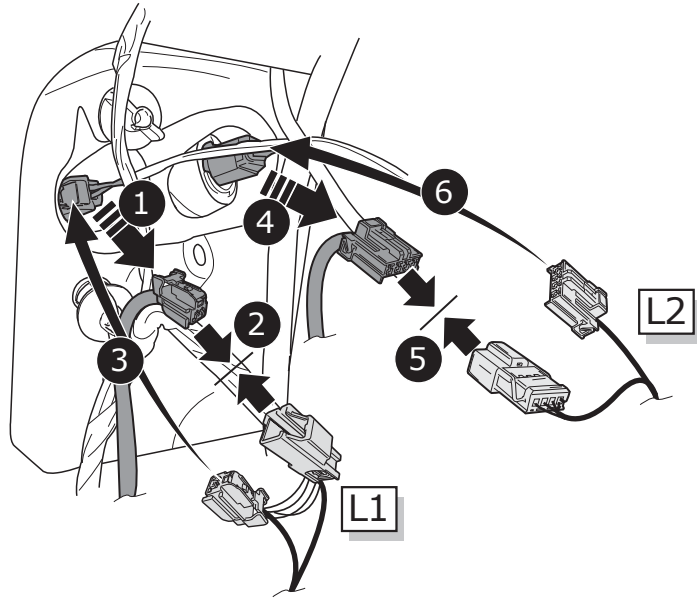
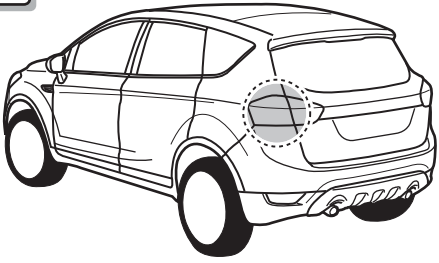

9

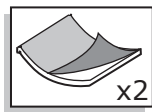
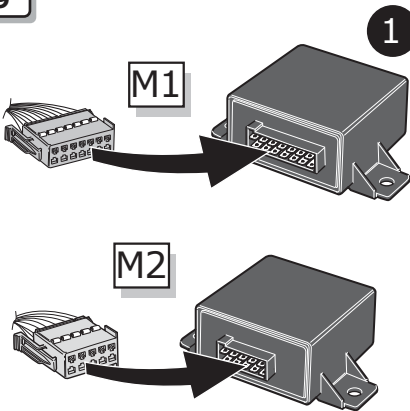

2

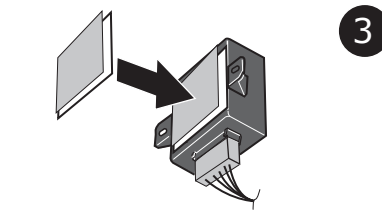
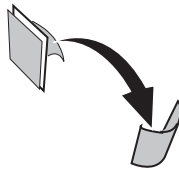

3

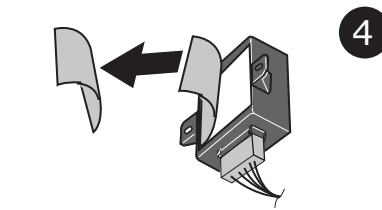

4

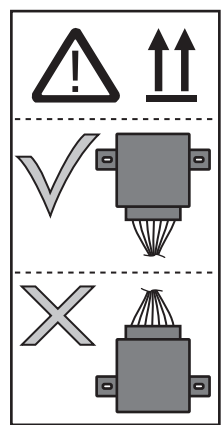

10

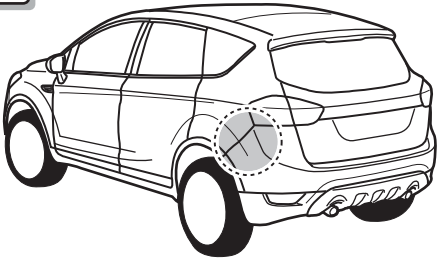

3

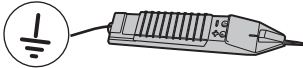

4

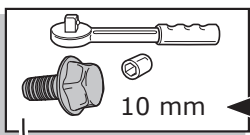
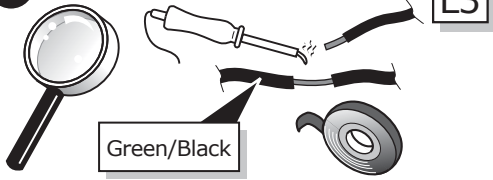

1

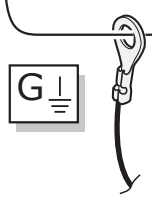

2

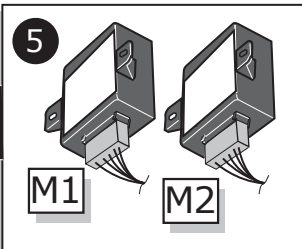
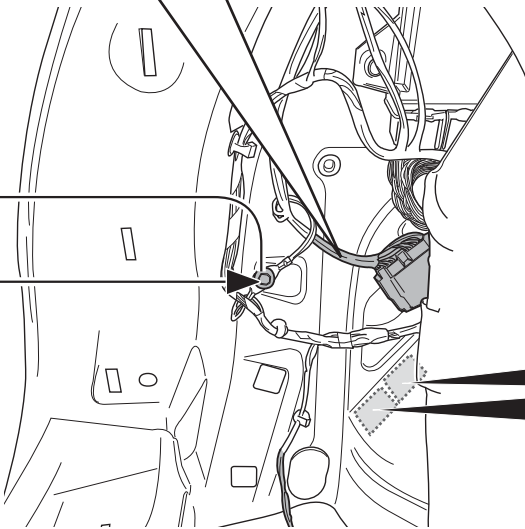

11

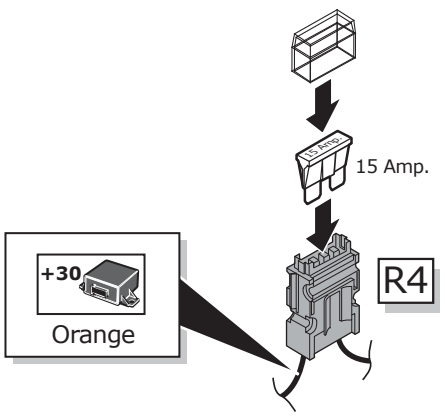

12

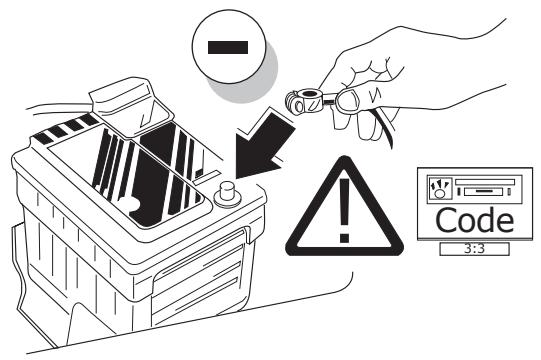

13



TEST ALL THE CIRCUITS WITH A TEST DEVICE WITH THE CORRECT POWER LOAD FOR EACH FUNCTION. A TEST DEVICE WITH LED'S CANNOT BE USED FOR THIS PURPOSE.

INFO

REINSTALL TRIM.

14

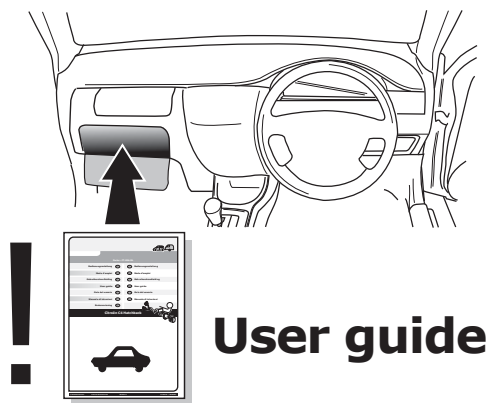







**TECHNICAL SUPPORT**

**CALL 07440 202 052**

**ECS ELECTRONICS** MONDAY TO FRIDAY  
08.00 - 11.00 am  
12.00 - 05.00 pm  
ukts@ecs-electronics.com  
www.ecs-electronicsuk.co.uk



SOCKET CONNECTION

DIN/ISO 1724			 1-7				
	1/L	2	3/31	4/R	5/58-R	6/54	7/58-L
Pmax	21W	2x21W		21W	52W	3x21W	52W
Colour	Yellow	Blue	White	Green	Brown	Red	Black

